



# SIOV metal oxide varistors

Leaded varistors, Automotive series

**Series/Type:** B722\*  
**Date:** January 2018

© EPCOS AG 2018. Reproduction, publication and dissemination of this publication, enclosures hereto and the information contained therein without EPCOS' prior express consent is prohibited.

EPCOS AG is a TDK Group Company.

**Automotive series**
**Construction**

- Round varistor element, leaded
- Coating: epoxy resin (D1: phenolic resin), flame-retardant to UL 94 V-0
- Terminals: tinned wire

**Features**

- High energy absorption, particularly for load dump
- Jump-start strength
- Stable protection level, minimum leakage current
- High resistance to cyclic temperature stress
- PSpice models
- High operating temperature range up to 125 °C
- All D1 types are AEC-Q200 qualified

**Delivery mode**

- Bulk (standard), taped versions on reel or in Ammo pack upon request.
- For further details refer to chapter "Taping, packaging and lead configuration" for leaded varistors.

**General technical data**

Climatic category	to IEC 60068-1 for D1 types	40/85/56 40/125/56	
Operating temperature	to IEC 61051 for D1 types	-40 ... + 85 -40 ... +125	°C °C
Storage temperature	for D1 types	-40 ... +125 -40 ... +150	°C °C
Electric strength	to IEC 61051	≥ 2.5 (not D1 types)	kV <sub>RMS</sub>
Insulation resistance	to IEC 61051	≥ 100 (not D1 types)	MΩ

**Leaded varistors**
**B722\***
**Automotive series**
**Electrical specifications and ordering codes**
**Maximum ratings ( $T_A = 85\text{ °C}$ ,  $T_A = 125\text{ °C}$  for S...D1 types)**

Ordering code	Type (untaped)	$V_{RMS}$ V	$V_{DC}$ V	$i_{max}$ (8/20 $\mu$ s) A	$W_{max}$ (2 ms) J	$P_{max}$ W	$W_{LD}$ (10 x) J
<b>12-V supply systems</b>							
B72207S1140K201	S07K14AUTOS2D1	14	16	250	0.9	0.02	12
B72210S1140K102	S10K14AUTO	14	16	500	2.0	0.05	25
B72210S1140K501	S10K14AUTOS5D1	14	16	500	2.0	0.05	25
B72214S1140K102	S14K14AUTO	14	16	1000	4.0	0.10	50
B72214S1140K501	S14K14AUTOS5D1	14	16	1000	4.0	0.10	50
B72220S1140K102	S20K14AUTO	14	16	2000	12.0	0.20	100
B72210S1170K102	S10K17AUTO	17	20	500	2.5	0.05	25
B72214S1170K102	S14K17AUTO	17	20	1000	5.0	0.10	50
B72220S1170K102	S20K17AUTO	17	20	2000	14.0	0.20	100
<b>24-V supply systems</b>							
B72220S1250K102	S20K25AUTO	25	28	2000	22.0	0.20	100
B72214S1300K102	S14K30AUTO	30	34	1000	9.0	0.10	50
B72220S1300K102	S20K30AUTO	30	34	2000	26.0	0.20	100

**Leaded varistors**
**B722\***
**Automotive series**
**Characteristics (T<sub>A</sub> = 25 °C)**

Ordering code	V <sub>Jump</sub> (5 min) V	V <sub>V</sub> (1 mA) V	ΔV <sub>V</sub> (1 mA) %	V <sub>C,max</sub> (i <sub>C</sub> ) V	i <sub>C</sub> A	C <sub>typ</sub> (1 kHz) nF
<b>12-V supply systems</b>						
B72207S1140K201	25	22	±10	43	2.5	2.3
B72210S1140K102	25	22	±10	43	5.0	5.2
B72210S1140K501	25	22	±10	43	5.0	5.2
B72214S1140K102	25	22	±10	43	10.0	10.0
B72214S1140K501	25	22	±10	43	10.0	10.0
B72220S1140K102	25	22	±10	43	20.0	19.0
B72210S1170K102	30	27	±10	53	5.0	4.4
B72214S1170K102	30	27	±10	53	10.0	8.2
B72220S1170K102	30	27	±10	53	20.0	15.6
<b>24-V supply systems</b>						
B72220S1250K102	40	39	±10	77	20.0	11.1
B72214S1300K102	45	47	±10	93	10.0	5.0
B72220S1300K102	45	47	±10	93	20.0	9.4

**Note:**

- If the maximum loads specified for load dump and jump start are fully utilized, subsequent polarity reversal of the AUTO varistors is inadmissible.
- If the load remains under the maximum ratings, polarity reversal may be admissible. Contact EPCOS for consultancy on this kind of problem.
- Load dump or jump start can decrease the varistor voltage in load direction by max. 15%.
- Load dump: min. time of energy input 40 ms, interval 60 s.

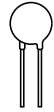
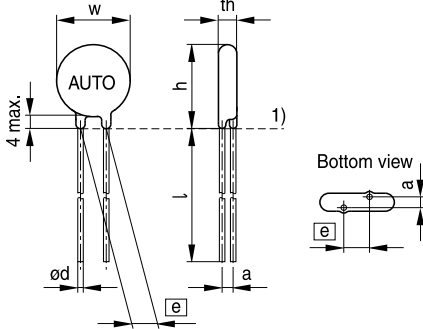
**Dimensional drawings**

1) Seating plane to IEC 60717

VAR0401-Y-E

**Weight**

Nominal diameter mm	$V_{RMS}$ V	Weight g
7	14	0.6 ... 0.8
10	14; 17	1.0 ... 2.0
14	14; 17; 30	2.0 ... 4.0
20	14; 17; 25; 30	3.0 ... 6.0

**Dimensions**

Ordering code	$[e] \pm 1$ mm	a (typical) mm	$w_{max}$ mm	$th_{max}$ mm	$h_{max}$ mm	$l_{min}$ mm	$d \pm 0.05$ mm
<b><math>V_{RMS} = 14 V</math></b>							
B72207S1140K201	5.0	1.3	9.0	3.5	12.5	25.0	0.6
B72210S1140K102	7.5	1.5	13.0	5.0	16.5	25.0	0.8
B72210S1140K501	7.5	1.5	12.0	4.0	16.0	25.0	0.8
B72214S1140K102	7.5	1.5	17.0	5.0	20.5	25.0	0.8
B72214S1140K501	7.5	1.5	16.0	4.0	20.0	25.0	0.8
B72220S1140K102	10.0	1.6	23.0	5.4	27.5	25.0	1.0
<b><math>V_{RMS} = 17 V</math></b>							
B72210S1170K102	7.5	1.6	13.0	5.1	16.5	25.0	0.8
B72214S1170K102	7.5	1.7	17.0	5.1	20.5	25.0	0.8
B72220S1170K102	10.0	1.6	23.0	5.6	27.5	25.0	1.0
<b><math>V_{RMS} = 25 V</math></b>							
B72220S1250K102	10.0	2.9	23.0	6.2	27.5	25.0	1.0
<b><math>V_{RMS} = 30 V</math></b>							
B72214S1300K102	7.5	1.8	17.0	5.3	20.5	25.0	0.8
B72220S1300K102	10.0	3.2	23.0	6.5	27.5	25.0	1.0

For crimp styles S2 and S5 refer to chapter "Taping, packaging and lead configuration".

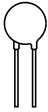

**Leaded varistors**
**B722\***
**Automotive series**
**Reliability data**

Test	Test methods/conditions	Requirement
Varistor voltage	The voltage between two terminals with the specified measuring current applied is called $V_V$ (1 mA <sub>DC</sub> @ 0.2 ... 2 s).	To meet the specified value
Clamping voltage	The maximum voltage between two terminals with the specified standard impulse current (8/20 $\mu$ s) applied.	To meet the specified value
Max. DC operating voltage	MIL STD 202F, method 108A, UCT, V <sub>DC</sub> , 1000 h	$ \Delta V/V$ (1 mA) $\leq$ 10% No visible damage
Load dump	ISO 7637-1, test pulse 5 ("load dump") (DIN 40 839 Part 1; impulse 5) 7 mm varistors (S07K...AUTO...): 10 $\times$ 12 J 10 mm varistors (S10K...AUTO...): 10 $\times$ 25 J 14 mm varistors (S14K...AUTO...): 10 $\times$ 50 J 20 mm varistors (S20K...AUTO...): 10 $\times$ 100 J (minimum 40 ms time of energy input, 60 s interval)	$\Delta V/V$ (1 mA) $\geq$ 15% No visible damage
Jump start	V <sub>DC, load</sub> = V <sub>jump</sub> ; 5 min duration 14 V (S...K14AUTO...); V <sub>jump</sub> = 25 V 17 V (S...K17AUTO...); V <sub>jump</sub> = 30 V 25 V (S...K25AUTO...); V <sub>jump</sub> = 40 V 30 V (S...K30AUTO...); V <sub>jump</sub> = 45 V	$\Delta V/V$ (1 mA) $\geq$ 15% No visible damage
Fast temperature cycling	IEC 60068-2-14, test Na, LCT/UCT, dwell time 15 min, 100 cycles for SIOV...AUTO types and dwell time 15 min, 1000 cycles for SIOV...AUTOD1 types	$ \Delta V/V$ (1 mA) $\leq$ 5% No visible damage
Damp heat	IEC 60068-2-67, test Cy, 85 °C, 85% r. H., V <sub>DC</sub> , 1000 h	$ \Delta V/V$ (1 mA) $\leq$ 10% No visible damage

**Note:**

UCT = Upper category temperature

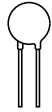
LCT = Lower category temperature



**v/i characteristics**

$v = f(i)$  - for explanation of the characteristics refer to "General technical information", 1.6.3  
 A = Leakage current, B = Protection level } for worst-case varistor tolerances

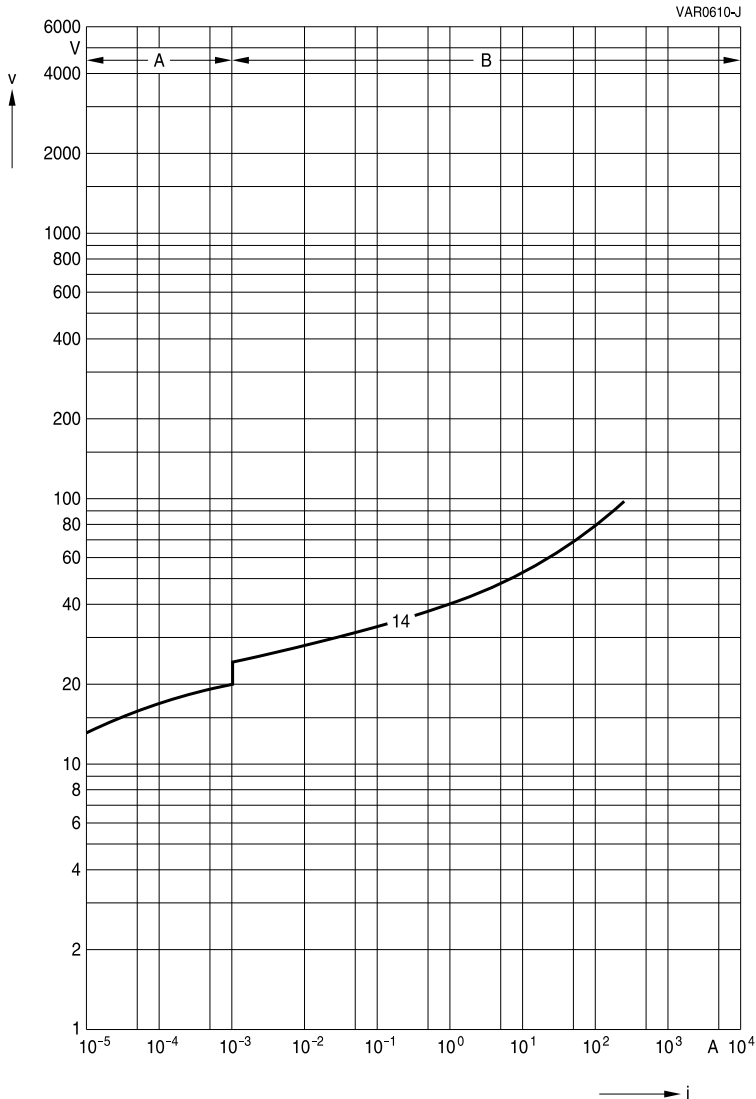

SIOV-S07 ... D1



**v/i characteristics**

$v = f(i)$  - for explanation of the characteristics refer to "General technical information", 1.6.3  
 A = Leakage current, B = Protection level } for worst-case varistor tolerances

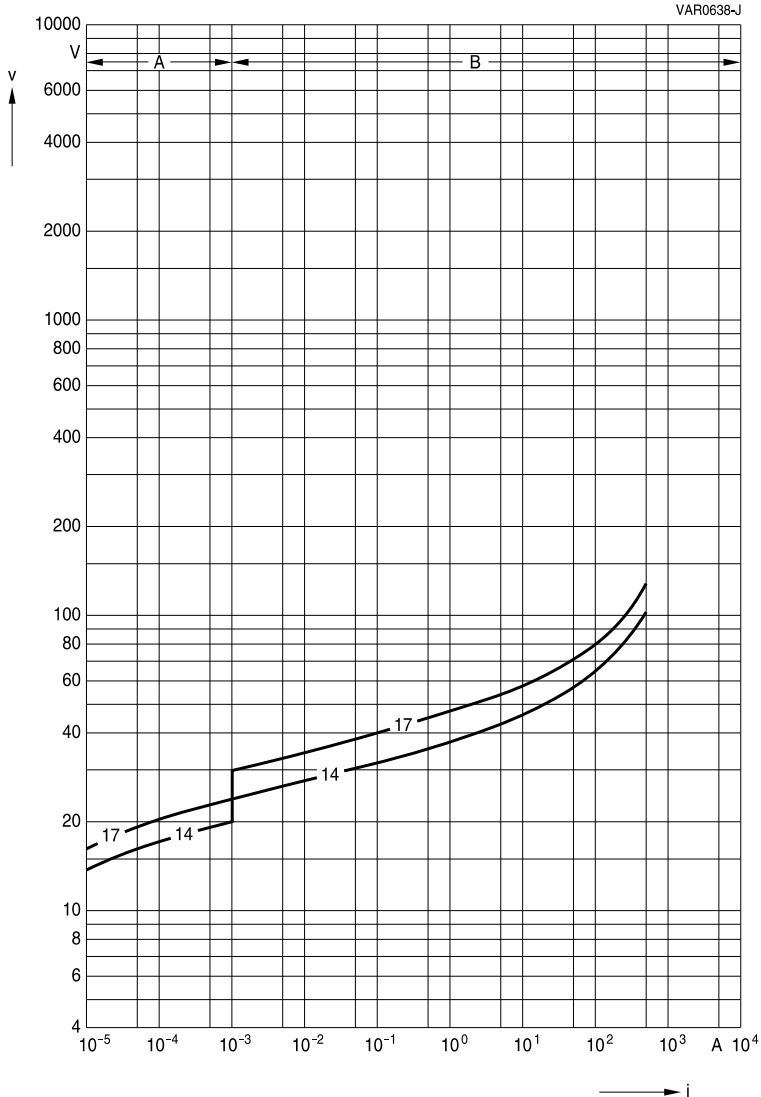

SIOV-S10 ... (AUTO)( D1)





**v/i characteristics**

$v = f(i)$  - for explanation of the characteristics refer to "General technical information", 1.6.3  
 A = Leakage current, B = Protection level } for worst-case varistor tolerances

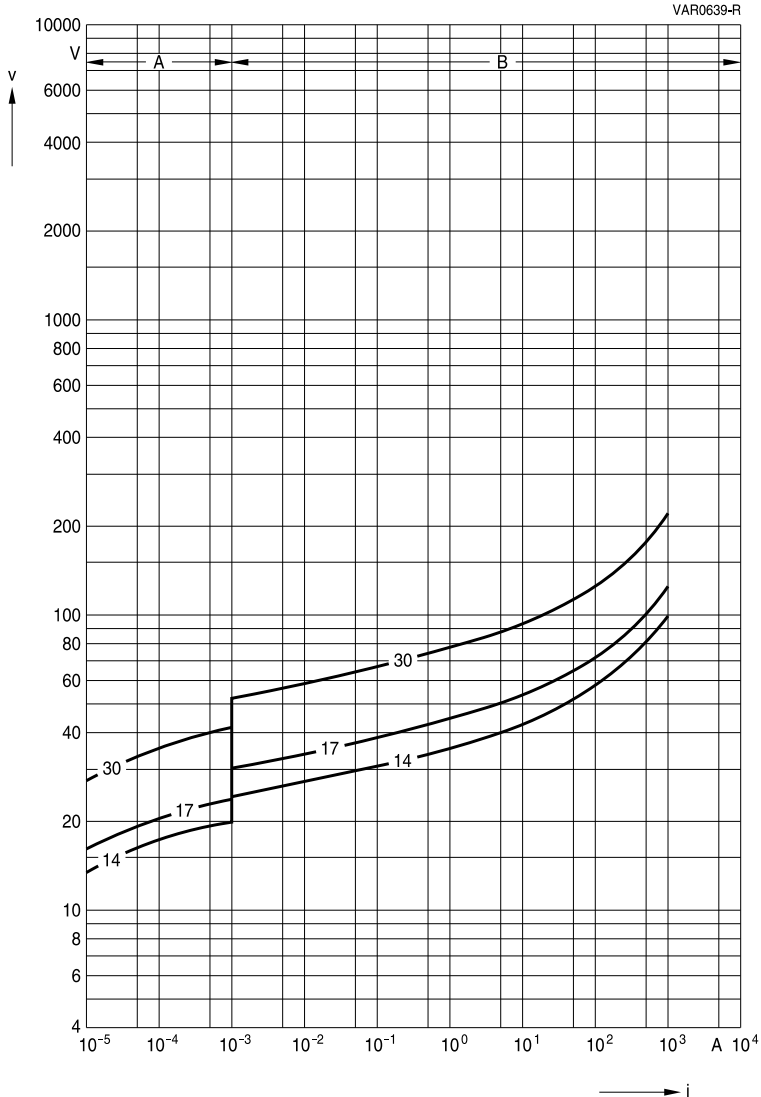

**SIOV-S14 ... (AUTO)( D1)**



**v/i characteristics**

$v = f(i)$  - for explanation of the characteristics refer to "General technical information", 1.6.3  
 A = Leakage current, B = Protection level } for worst-case varistor tolerances

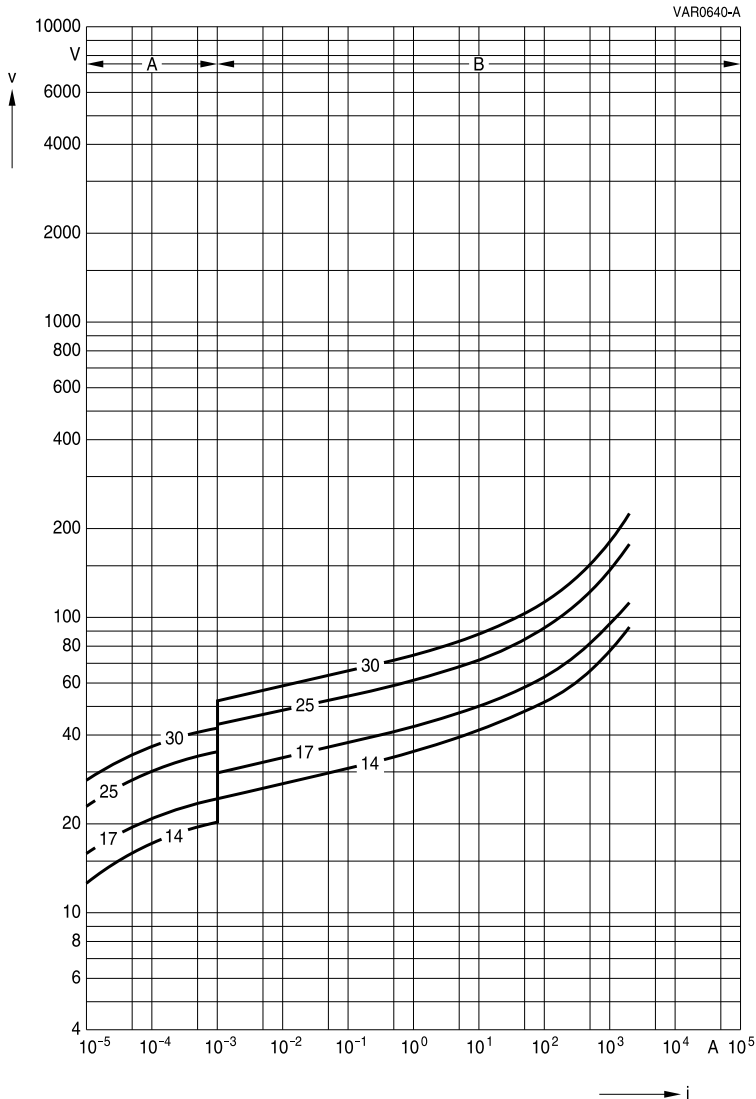

**SIOV-S20 ... AUTO**





**Derating curves**

Maximum surge current  $i_{max} = f(t_r, \text{pulse train})$

For explanation of the derating curves refer to "General technical information", section 1.8.1

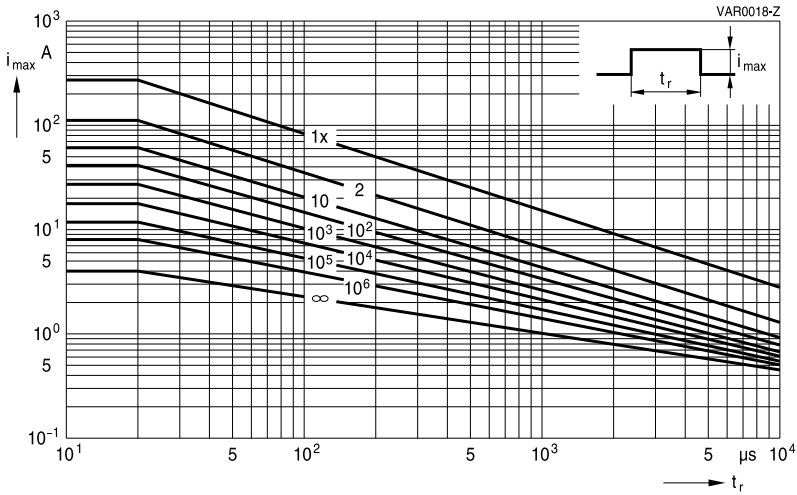

**SIOV-S07K14AUTOS2D1**

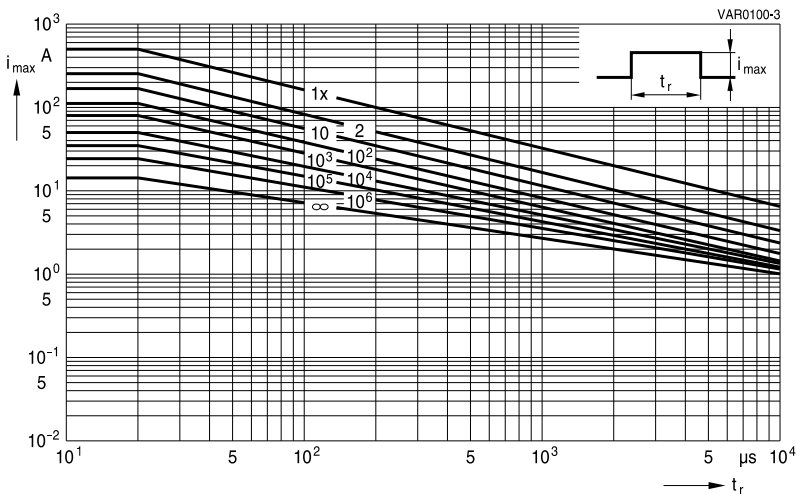

**SIOV-S10K14AUTO ... K17AUTO**

**SIOV-S10K14AUTOS5D1**

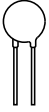

**Derating curves**

Maximum surge current  $i_{max} = f(t_r, \text{pulse train})$

For explanation of the derating curves refer to "General technical information", section 1.8.1

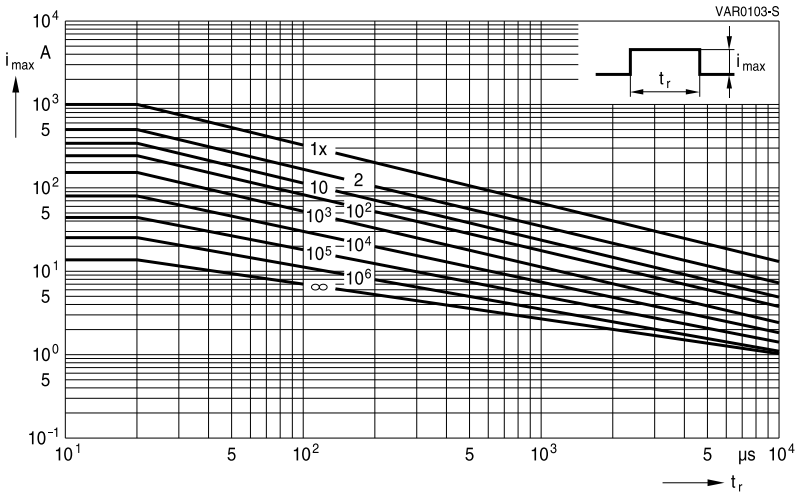

**SIOV-S14K14AUTO ... K30AUTO**

**SIOV-S14K14AUTOS5D1**

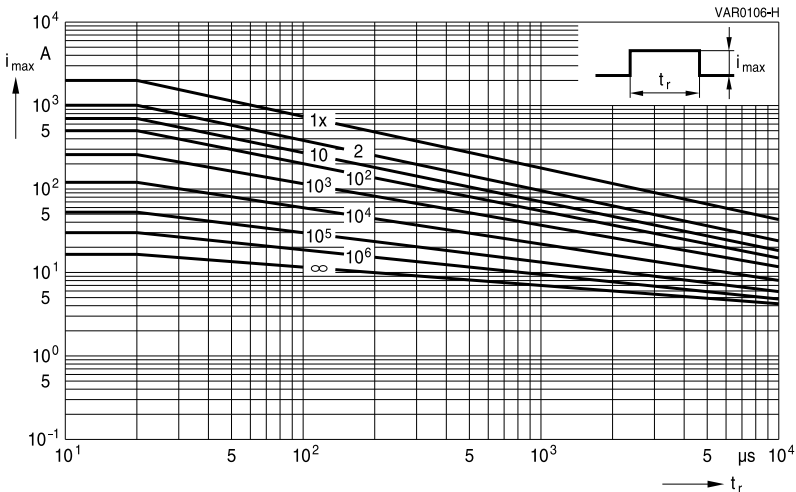

**SIOV-S20K14AUTO ... K30AUTO**



**Leaded varistors**

**B722\***

**Automotive series**

**Taping, packaging and lead configuration**

**1 EPCOS ordering code system**

**For leaded varistors**

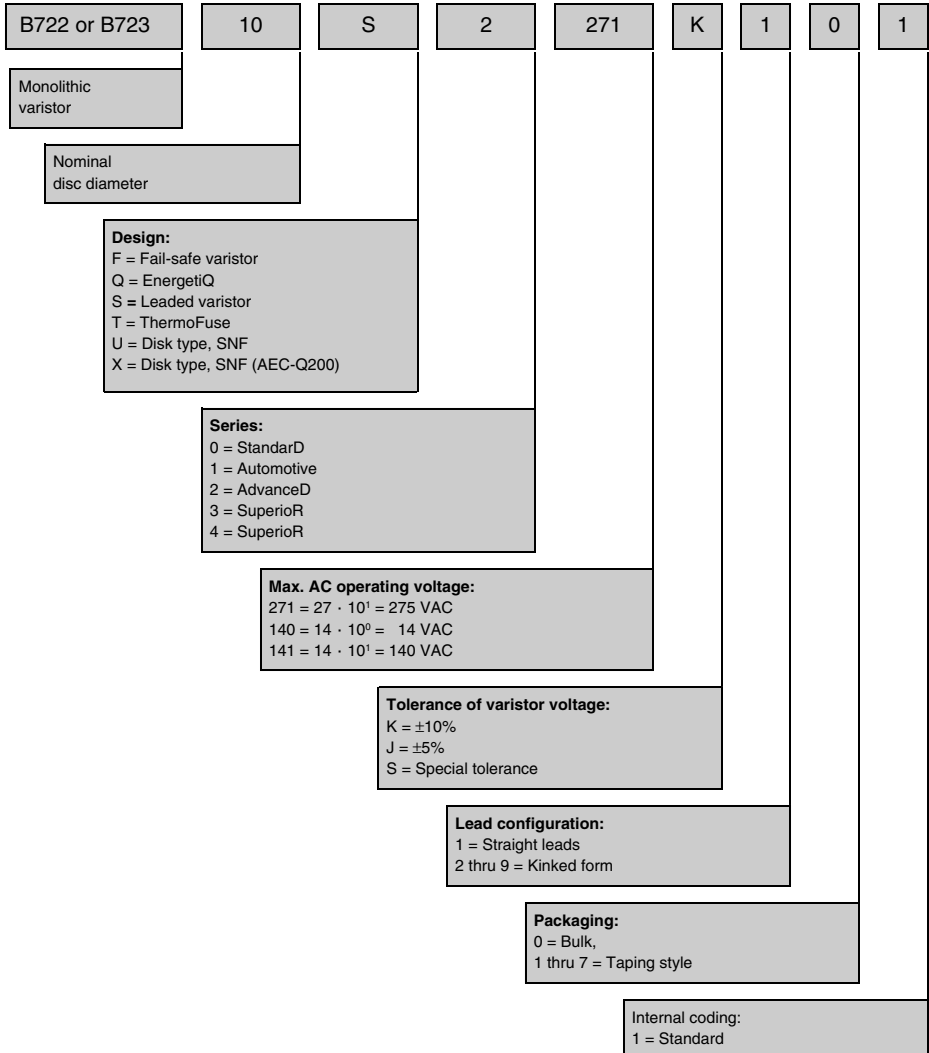



**Leaded varistors**

**B722\***

**Automotive series**

**2 Taping and packaging of leaded varistors**

Tape packaging for lead spacing  $e = 5$  fully conforms to IEC 60286-2, while for lead spacings  $e = 7.5$  and  $10$  the taping mode is based on this standard.

**2.1 Taping in accordance with IEC 60286-2 for lead spacing 5.0 mm**

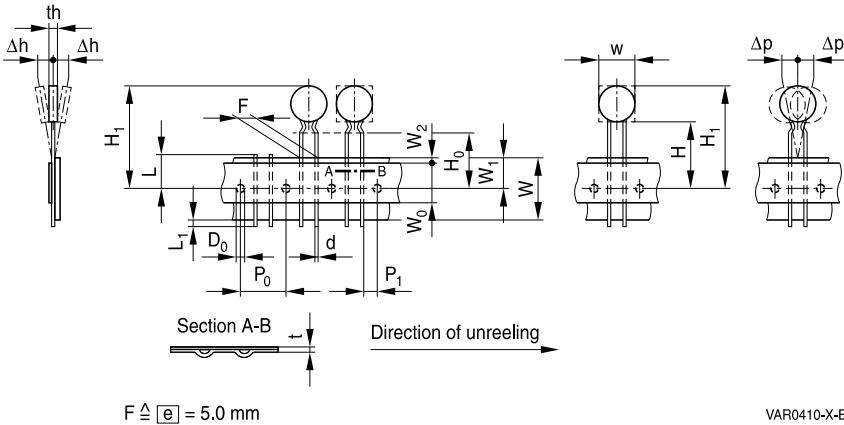

**2.2 Taping based on IEC 60286-2 for lead spacing 7.5 and 10 mm**

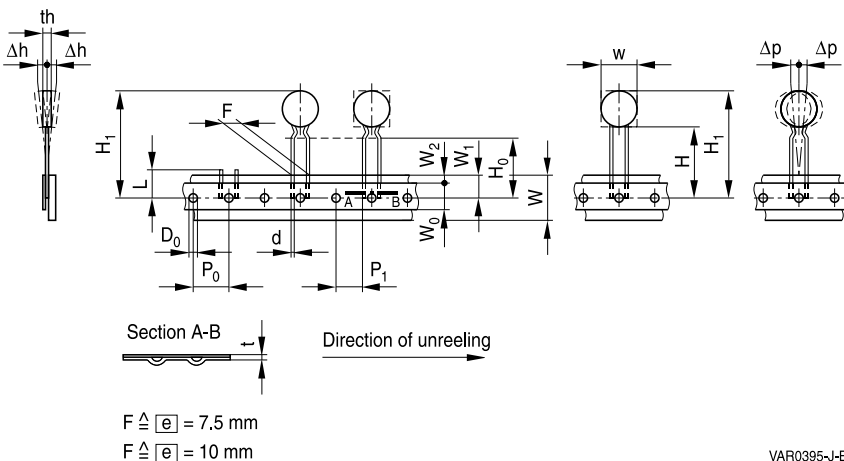



### 2.3 Tape dimensions (in mm)

Symbol	$e = 5.0$	Tolerance	$e = 7.5$	Tolerance	$e = 10.0$	Tolerance	Remarks
w		max.		max.		max.	see tables in each series under "Dimensions"
th		max.		max.		max.	
d	0.6	$\pm 0.05$	0.8	$\pm 0.05$	1.0	$\pm 0.05$	
P <sub>0</sub>	12.7	$\pm 0.3$	12.7 <sup>1)</sup>	$\pm 0.3$	12.7	$\pm 0.3$	$\pm 1$ mm/20 sprocket holes
P <sub>1</sub>	3.85	$\pm 0.7$	8.95	$\pm 0.8$	7.7	$\pm 0.8$	
F	5.0	$+0.6/-0.1$	7.5	$\pm 0.8$	10.0	$\pm 0.8$	measured at top of component body
$\Delta h$	0	$\pm 2.0$	depends on s		depends on s		
$\Delta p$	0	$\pm 1.3$	0	$\pm 2.0$	0	$\pm 2.0$	
W	18.0	$\pm 0.5$	18.0	$\pm 0.5$	18.0	$\pm 0.5$	Peel-off force $\geq 5$ N
W <sub>0</sub>	5.5	min.	11.0	min.	11.0	min.	
W <sub>1</sub>	9.0	$\pm 0.5$	9.0	$+0.75/-0.5$	9.0	$+0.75/-0.5$	
W <sub>2</sub>	3.0	max.	3.0	max.	3.0	max.	
H	18.0	$+2.0/-0$	18.0	$+2.0/-0$	18.0	$+2.0/-0$	2) 3)
H <sub>0</sub>	16.0 (18.0)	$\pm 0.5$	16.0 (18.0)	$\pm 0.5$	16.0	$\pm 0.5$	
H <sub>1</sub>	32.2	max.	45.0	max.	45.0	max.	
D <sub>0</sub>	4.0	$\pm 0.2$	4.0	$\pm 0.2$	4.0	$\pm 0.2$	without lead
t	0.9	max.	0.9	max.	0.9	max.	
L	11.0	max.	11.0	max.	11.0	max.	
L <sub>1</sub>	0.5	max.					

1) Taping with P<sub>0</sub> = 15.0 mm upon request

2) Applies only to uncrimped types

3) Applies only to crimped types (H<sub>0</sub> = 18 upon request)

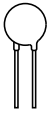

**Leaded varistors**

**B722\***

**Automotive series**

## 2.4 Taping mode

Example: B72210S0271K1 **5** 1  
 Digit 14

Digit 14	Taping mode	Reel type	Seating plane height $H_0$ for crimped types mm	Seating plane height $H$ for uncrimped types mm	Pitch distance $P_0$ mm
0	—	Bulk	—	—	—
1	G	I	16	18	12.7
2	G2	I	18	—	12.7
3	G3	II	16	18	12.7
4	G4	II	18	—	12.7
5	G5	III	16	18	12.7
6	GA	Ammo pack	16	18	12.7
7	G2A	Ammo pack	18	—	12.7

Internal coding for special taping

G6	III	18	—	12.7
G10	II	16	18	15.0
G11	II	18	—	15.0
G10A	Ammo pack	16	18	15.0
G11A	Ammo pack	18	—	15.0

## 2.5 Reel dimension

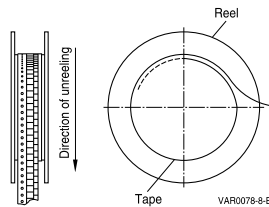
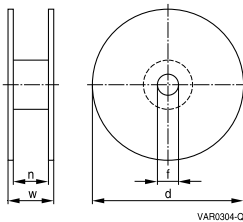

### Dimensions (in mm)

Reel type	d	f	n	w
I	360 max.	31 ±1	approx. 45	54 max.
II	360 max.	31 ±1	approx. 55	64 max.
III	500 max.	23 ±1	approx. 59	72 max.

If reel type III is not compatible with insertion equipment because of its large diameter, nominal disk diameter 10 mm and 14 mm can be supplied on reel II upon request (taping mode G3).



## 2.6 Ammo pack dimensions

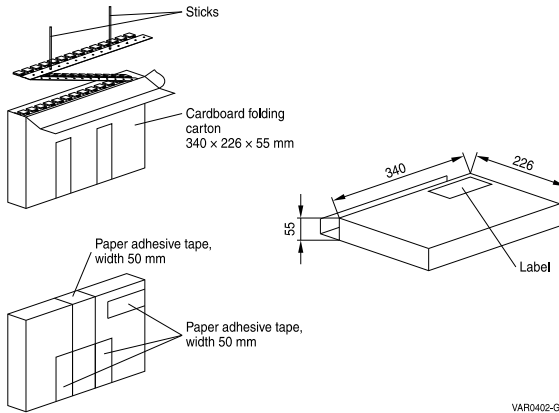

VAR0402-G

## 3 Lead configuration

Straight leads are standard for disk varistors. Other lead configurations as crimp style or customer-specific lead wire length according to 3.1, 3.2, 3.3 and 3.4 are optional. Crimped leads (non-standard) are differently crimped for technical reasons; the individual crimp styles are denoted by consecutive numbers (S, S2 through S5) as shown in the dimensional drawings below.

The crimp styles of the individual types can be seen from the type designation in the ordering tables.

### 3.1 Crimp style mode

Example: B72210S0271K **5** 01  
 Digit 13

Digit 13 of ordering code	Crimp style	Figure
1	Standard, straight leads	1
2	S2	2
3	S3	3
5	S5	4
Available upon request		
Internal coding	—	5



### 3.2 Standard leads and non-standard crimp styles

The basic dimensions in figure 1 to 5 are valid for types with either round or square (EnergetiQ series) component head.

#### Standard, straight leads

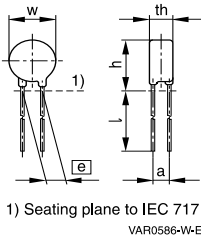
**Figure 1**

#### Non-standard, crimp style S2

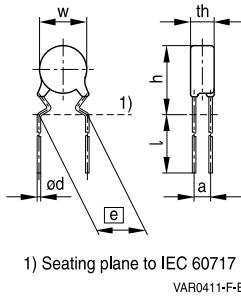
**Figure 2**

#### Non-standard, crimp style S3

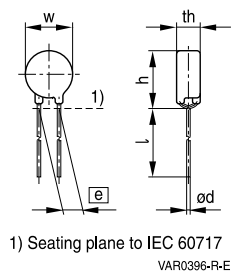
**Figure 3**

#### Non-standard, crimp style S5

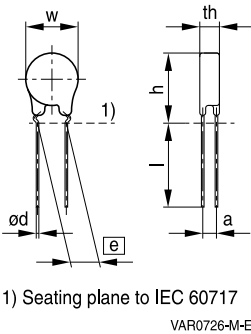
**Figure 4**



### 3.3 Trimmed leads (non-standard)

Varistors with cut leads available upon request.

Lead length tolerances:

Straight leads  $\pm 0.8$  mm

Crimped leads  $\pm 0.5$  mm

Minimum lead length 3.0 mm

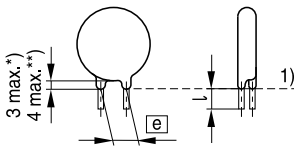

1) Seating plane to IEC 60717

\*) For round component head

\*\*\*) For EnergetiQ series, square component head

VAR0642-U-E

**Figure 5**



## Cautions and warnings

### General

1. EPCOS metal oxide varistors are designed for specific applications and should not be used for purposes not identified in our specifications, application notes and data books unless otherwise agreed with EPCOS during the design-in-phase.
2. Ensure suitability of SIOVs through reliability testing during the design-in phase. SIOVs should be evaluated taking into consideration worst-case conditions.
3. For applications of SIOVs in line-to-ground circuits based on various international and local standards there are restrictions existing or additional safety measures required.

### Storage

1. Store SIOVs only in original packaging. Do not open the package prior to processing.
2. Recommended storage conditions in original packaging:  
 Storage temperature:  $-25\text{ }^{\circ}\text{C} \dots +45\text{ }^{\circ}\text{C}$ ,  
 Relative humidity:  $<75\%$  annual average,  
 $<95\%$  on maximum 30 days a year.  
 Dew precipitation: is to be avoided.
3. Avoid contamination of an SIOV's during storage, handling and processing.
4. Avoid storage of SIOVs in harmful environments that can affect the function during long-term operation (examples given under operation precautions).
5. The SIOV type series should be soldered after shipment from EPCOS within the time specified:
 

SIOV-S, -Q, -LS, -B, -SNF	24 months
ETFV/ T series, -CU	12 months.

### Handling

1. SIOVs must not be dropped.
2. Components must not be touched with bare hands. Gloves are recommended.
3. Avoid contamination of the surface of SIOV electrodes during handling, be careful of the sharp edge of SIOV electrodes.

### Soldering (where applicable)

1. Use rosin-type flux or non-activated flux.
2. Insufficient preheating may cause ceramic cracks.
3. Rapid cooling by dipping in solvent is not recommended.
4. Complete removal of flux is recommended.
5. Temperatures of all preheat stages and the solder bath must be strictly controlled especially for T series (T14 and T20).



### Mounting

1. Potting, sealing or adhesive compounds can produce chemical reactions in the SIOV ceramic that will degrade the component's electrical characteristics.
2. Overloading SIOVs may result in ruptured packages and expulsion of hot materials. For this reason SIOVs should be physically shielded from adjacent components.

### Operation

1. Use SIOVs only within the specified temperature operating range.
2. Use SIOVs only within the specified voltage and current ranges.
3. Environmental conditions must not harm SIOVs. Use SIOVs only in normal atmospheric conditions. Avoid use in deoxidizing gases (chlorine gas, hydrogen sulfide gas, ammonia gas, sulfuric acid gas etc), corrosive agents, humid or salty conditions. Contact with any liquids and solvents should be prevented.

### Display of ordering codes for EPCOS products

The ordering code for one and the same EPCOS product can be represented differently in data sheets, data books, other publications, on the EPCOS website, or in order-related documents such as shipping notes, order confirmations and product labels. **The varying representations of the ordering codes are due to different processes employed and do not affect the specifications of the respective products.** Detailed information can be found on the Internet under [www.epcos.com/orderingcodes](http://www.epcos.com/orderingcodes)

**Symbols and terms**

Symbol	Term
C	Capacitance
$C_{typ}$	Typical capacitance
i	Current
$i_c$	Current at which $V_{c, max}$ is measured
$I_{leak}$	Leakage current
$i_{max}$	Maximum surge current (also termed peak current)
$I_{max}$	Maximum discharge current
$I_n$	Nominal discharge current to UL 1449
LCT	Lower category temperature
$L_{typ}$	Typical inductance
$P_{max}$	Maximum average power dissipation
$R_{ins}$	Insulation resistance
$R_{min}$	Minimum resistance
$T_A$	Ambient temperature
$t_r$	Duration of equivalent rectangular wave
UCT	Upper category temperature
v	Voltage
$V_{clamp}$	Clamping voltage
$V_{c, max}$	Maximum clamping voltage at specified current $i_c$
$V_{DC}$	DC operating voltage
$V_{jump}$	Maximum jump start voltage
$V_{max}$	Maximum voltage
$V_{op}$	Operating voltage
$V_{RMS}$	AC operating voltage, root-mean-square value
$V_{RMS, op, max}$	Root-mean-square value of max. DC operating voltage incl. ripple current
$V_{surge}$	Super imposed surge voltage
$V_V$	Varistor voltage
$\Delta V_V$	Tolerance of varistor voltage
$W_{LD}$	Maximum load dump
$W_{max}$	Maximum energy absorption
$e$	Lead spacing

All dimensions are given in mm.

The commas used in numerical values denote decimal points.

## Important notes

The following applies to all products named in this publication:

1. Some parts of this publication contain **statements about the suitability of our products for certain areas of application**. These statements are based on our knowledge of typical requirements that are often placed on our products in the areas of application concerned. We nevertheless expressly point out **that such statements cannot be regarded as binding statements about the suitability of our products for a particular customer application**. As a rule we are either unfamiliar with individual customer applications or less familiar with them than the customers themselves. For these reasons, it is always ultimately incumbent on the customer to check and decide whether a product with the properties described in the product specification is suitable for use in a particular customer application.
2. We also point out that **in individual cases, a malfunction of electronic components or failure before the end of their usual service life cannot be completely ruled out in the current state of the art, even if they are operated as specified**. In customer applications requiring a very high level of operational safety and especially in customer applications in which the malfunction or failure of an electronic component could endanger human life or health (e.g. in accident prevention or life-saving systems), it must therefore be ensured by means of suitable design of the customer application or other action taken by the customer (e.g. installation of protective circuitry or redundancy) that no injury or damage is sustained by third parties in the event of malfunction or failure of an electronic component.
3. **The warnings, cautions and product-specific notes must be observed.**
4. In order to satisfy certain technical requirements, **some of the products described in this publication may contain substances subject to restrictions in certain jurisdictions (e.g. because they are classed as hazardous)**. Useful information on this will be found in our Material Data Sheets on the Internet ([www.tdk-electronics.tdk.com/material](http://www.tdk-electronics.tdk.com/material)). Should you have any more detailed questions, please contact our sales offices.
5. We constantly strive to improve our products. Consequently, **the products described in this publication may change from time to time**. The same is true of the corresponding product specifications. Please check therefore to what extent product descriptions and specifications contained in this publication are still applicable before or when you place an order.

We also **reserve the right to discontinue production and delivery of products**. Consequently, we cannot guarantee that all products named in this publication will always be available. The aforementioned does not apply in the case of individual agreements deviating from the foregoing for customer-specific products.

6. Unless otherwise agreed in individual contracts, **all orders are subject to our General Terms and Conditions of Supply**.
7. **Our manufacturing sites serving the automotive business apply the IATF 16949 standard**. The IATF certifications confirm our compliance with requirements regarding the quality management system in the automotive industry. Referring to customer requirements and customer specific requirements ("CSR") TDK always has and will continue to have the policy of respecting individual agreements. Even if IATF 16949 may appear to support the acceptance of unilateral requirements, we hereby like to emphasize that **only requirements mutually agreed upon can and will be implemented in our Quality Management System**. For clarification purposes we like to point out that obligations from IATF 16949 shall only become legally binding if individually agreed upon.

## Important notes

8. The trade names EPCOS, CeraCharge, CeraDiode, CeraLink, CeraPad, CeraPlas, CSMP, CTVS, DeltaCap, DigiSiMic, ExoCore, FilterCap, FormFit, LeaXield, MiniBlue, MiniCell, MKD, MKK, MotorCap, PCC, PhaseCap, PhaseCube, PhaseMod, PhiCap, PowerHap, PQSine, PQvar, SIFERRIT, SIFI, SIKOREL, SilverCap, SIMDAD, SiMic, SIMID, SineFormer, SIOV, ThermoFuse, WindCap are **trademarks registered or pending** in Europe and in other countries. Further information will be found on the Internet at [www.tdk-electronics.tdk.com/trademarks](http://www.tdk-electronics.tdk.com/trademarks).

Release 2018-10