

June 1996

#### Features

- Complementary Drive, Half-Bridge Power NMOS
- Use With Low-Cost Single-Output PWM Controllers
- Improve Efficiency Over Conventional Buck Converter With Schottky Clamp
- Minimum Deadtime Provided by Adaptive Shoot-Through Protection Eliminates External Schottky
- Grounded Case for Low EMI and Simple Heatsinking
- Low Operating Current
- Frequency Exceeding 1MHz
- Dual Polarity Input Options
- All Pins Surge Protected

#### Applications

- 5V to  $\leq 3.3V$  Synchronous Buck Converters
- 3.3V to  $\leq 2.9V$  Synchronous Buck Converters
- Pentium™ Power Supplies
- Bus Terminations (BTL and GTL)
- Drive 5V Motors Directly from Microprocessor

#### Ordering Information

PART NUMBER	TEMP. RANGE (°C)	PACKAGE	PKG. NO.
HIP5015IS	-40 to 85	7 Ld Gullwing SIP	Z7.05B
HIP5015IS1	-40 to 85	7 Ld Staggered Vertical SIP	Z7.05C
HIP5016IS	-40 to 85	7 Ld Gullwing SIP	Z7.05B
HIP5016IS1	-40 to 85	7 Ld Staggered Vertical SIP	Z7.05C

#### Description

Designed with the Pentium™ in mind, the Harris SynchroFET™ family provides a new approach for implementing a synchronous rectified buck switching regulator. The SynchroFET™ replaces two power DMOSs, a Schottky diode, two gate drivers and synchronous control circuitry. The complementary drive circuit turns the upper FET on and the lower FET off when the input from the PWM is high. When the input from the PWM goes low the upper FET turns off and the lower FET turns on. The HIP5016 has a  $\overline{PWM}$  pin that inverts the relationship from the input to PHASE. This architecture allows the designer to utilize a low cost single-ended PWM controller in either a current or voltage mode configuration. The SynchroFET™ operates in continuous conduction mode reducing EMI constraints and enabling high bandwidth operation. Several features ensure easy start-up. First, the supply currents stay below specification as the supply voltages ramp up; no unexpected surges occur that might perturb a soft-start or deplete a charge-pump. Second, any power-up sequence of the  $V_{CC}$ ,  $V_{IN}$ , or PWM pins can be used without causing large currents. Third, the chip operates when  $V_{CC}$  is greater than 2V so  $V_{CC}$  can be created from a charge pump powered from  $V_{IN}$ .

#### Typical Application Block Diagram

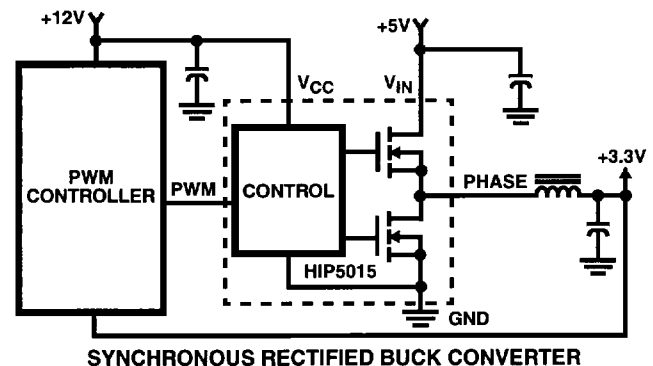

#### Pinouts

HIP5015IS1, HIP5016IS1 (SIP - VERTICAL)  
TOP VIEW

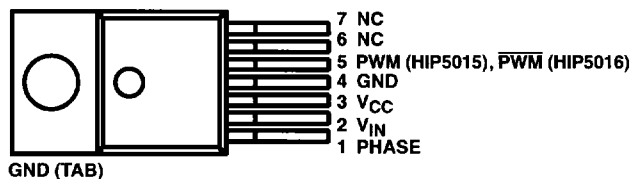

FRONT ROWS = PINS 1,3,5,7  
BACK ROWS = PINS 2,4,6

HIP5015IS, HIP5016IS (SIP - GULLWING)  
TOP VIEW

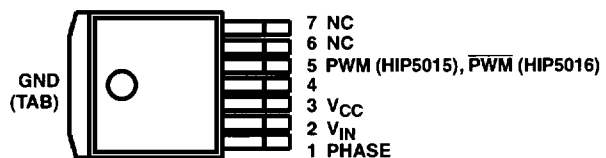

Pentium™ is a trademark of Intel Corporation.  
SynchroFET™ is a trademark of Harris Corporation.

\*HRIS083\*

**Non-Inverting SynchroFET™ Block Diagram**

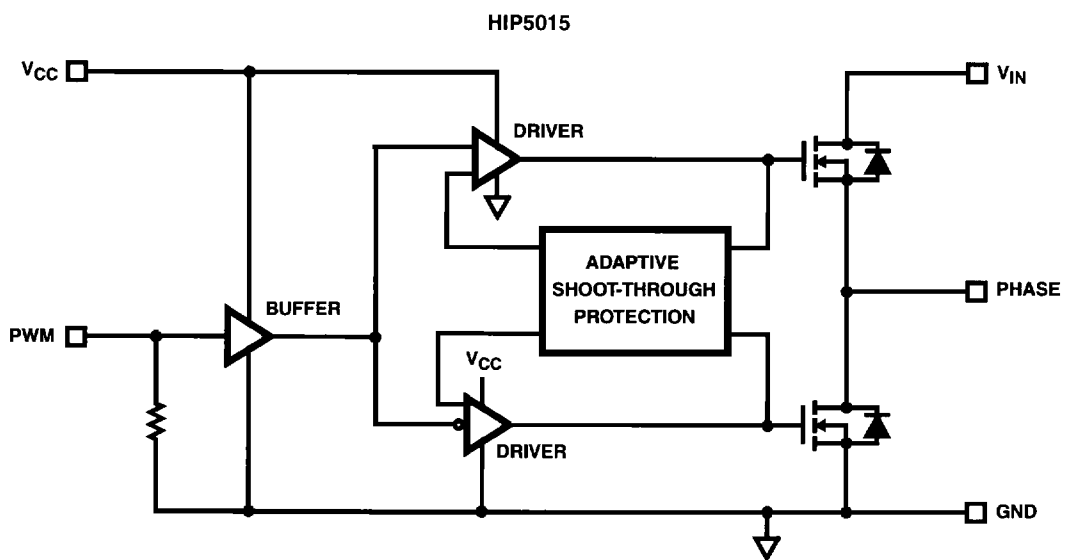

**Inverting SynchroFET™ Block Diagram**

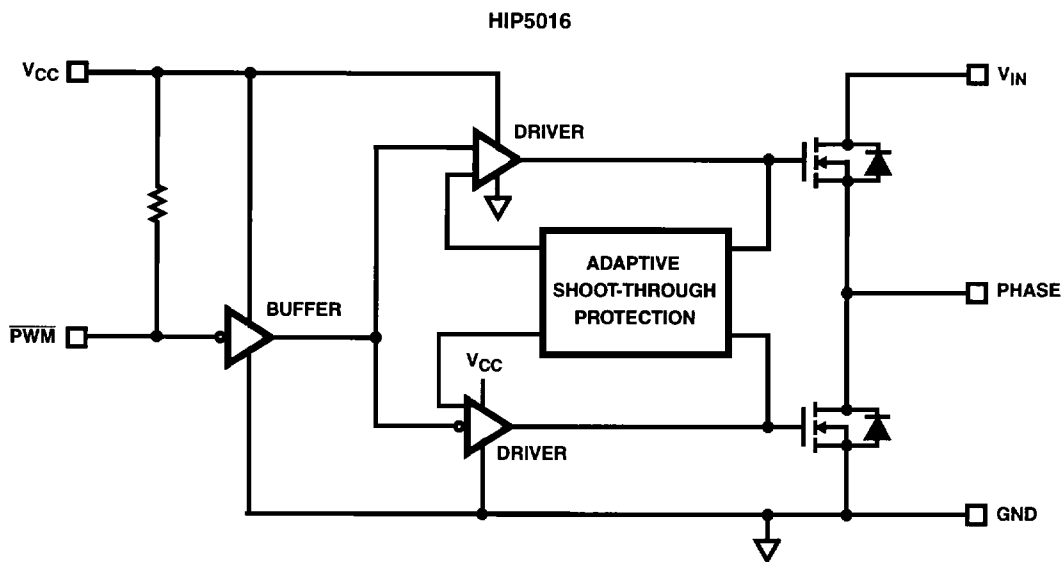

# HIP5015, HIP5016

## Absolute Maximum Ratings

Supply Voltage, $V_{CC}$ .....	+16V
Input Voltage $V_{IN}$ .....	+7V
$I_{PHASE}$ , $I_{VIN}$ , $I_{GND}$ .....	7A (Repetitive Peak)
PWM Input .....	-4V to +16V
ESD Classification .....	Class 3 (4kV)
Lead Temperature (Soldering 10s) (Lead Tips Only) .....	+300°C
Storage Temperature Range .....	-65°C to +150°C
Junction Temperature Range .....	-40°C to +150°C

## Thermal Information (Typical)

Package	$\theta_{JC}^{\dagger\dagger}$ (°C/W)	$\theta_{JA}$ (°C/W) <sup>†</sup>				
		0	1	2	3	3†††
SIP (IS) .....	2	55	30	25	24	18
SIP (IS1) .....	2	55	-	-	-	-

† Versus additional square inches of 1 ounce copper on the printed circuit board.

††  $\theta_{JC}$  is typical with an infinite heatsink.

††† 200 linear feet per minute of air flow.

*CAUTION: Stresses above those listed in "Absolute Maximum Ratings" may cause permanent damage to the device. This is a stress only rating and operation of the device at these or any other conditions above those indicated in the recommended operating conditions of this specification is not implied.*

## Recommended Operating Conditions

Supply Voltage, $V_{CC}$ .....	+12V, $\pm 20\%$	$I_{PHASE}$ .....	5A
Input Voltage $V_{IN}$ .....	0V to 5.5V	$I_{VIN}$ .....	4A
Supply Voltage, $V_{CC}$ , minimum for charge-pumped start-up .....	+4.0V	$I_{GND}$ .....	3A

## Electrical Specifications

PARAMETERS	SYMBOL	TEST CONDITIONS	$T_J = 25^\circ\text{C}$			$T_J = -40^\circ\text{C}$ $T_J = +150^\circ\text{C}$		UNITS
			MIN	TYP	MAX	MIN	MAX	
$r_{DS(ON)}$ Upper MOSFET	$R_{DSU}$	$V_{CC} = 12\text{V}$ , $V_{IN} = 5\text{V}$	-	68	78	-	130	m $\Omega$
$r_{DS(ON)}$ Lower MOSFET	$R_{DSL}$	$V_{CC} = 12\text{V}$ , $V_{IN} = 5\text{V}$	-	72	82	-	136	m $\Omega$
$V_{IN}$ Operating Current	$I_{VINO}$	$V_{IN} = 5\text{V}$ , No Load, 500kHz	-	1.8	4	-	5	mA
$V_{IN}$ Quiescent Current	$I_{VIN}$	PWM or $\overline{\text{PWM}} = V_{CC}$ or GND	-	0.1	10	-	100	$\mu\text{A}$
$V_{CC}$ Operating Current	$I_{CCO}$	$V_{CC} = 12\text{V}$ , 500kHz	-	4.3	7	-	9	mA
$V_{CC}$ Quiescent Current (HIP5015)	$I_{CCIH}$	PWM = $V_{CC}$	-	40	-	-	300	$\mu\text{A}$
$V_{CC}$ Quiescent Current (HIP5015)	$I_{CCIL}$	PWM = GND	-	0.1	10	-	100	$\mu\text{A}$
$V_{CC}$ Quiescent Current (HIP5016)	$I_{CCNIH}$	$\overline{\text{PWM}} = V_{CC}$	-	0.1	10	-	100	$\mu\text{A}$
$V_{CC}$ Quiescent Current (HIP5016)	$I_{CCNIL}$	$\overline{\text{PWM}} = \text{GND}$	-	100	-	-	300	$\mu\text{A}$
Low Level PWM Input Voltage	$V_{IL}$		-	1.8	-	1	-	V
High Level PWM Input Voltage	$V_{IH}$		-	2.1	-	-	3	V
PWM Input Voltage Hysteresis	$V_{IHYS}$		-	0.3	-	-	-	V
Input Pulldown Resistance (HIP5015)	$R_{PWM}$		-	220	-	100	400	k $\Omega$
Input Pullup Resistance (HIP5016)	$R_{PWM}$		-	220	-	100	400	k $\Omega$

## Switching Specifications

PARAMETERS	SYMBOL	TEST CONDITIONS	$T_J = 25^\circ\text{C}$			$T_J = -40^\circ\text{C}$ $T_J = +150^\circ\text{C}$		UNITS
			MIN	TYP	MAX	MIN	MAX	
Upper Device Turn-Off Delay	$t_{PHL}$	$V_{CC} = 12\text{V}$ , $I_{PHASE} = -0.5\text{A}$	-	30	50	-	80	ns
Lower Device Turn-Off Delay	$t_{PLH}$	$V_{CC} = 12\text{V}$ , $I_{PHASE} = +0.5\text{A}$	-	30	50	-	80	ns
Dead Time	$t_{DT}$	$V_{CC} = +12\text{V}$ , $I_{PHASE} = -0.5\text{A}$	-	10	-	-	-	ns
Phase Rise-Time	$t_R$	$V_{CC} = 12\text{V}$ , $I_{PHASE} = -0.5\text{A}$	-	20	-	-	-	ns
Phase Fall-Time	$t_F$	$V_{CC} = 12\text{V}$ , $I_{PHASE} = +0.5\text{A}$	-	20	-	-	-	ns

# HIP5015, HIP5016

## Pin Descriptions

SYMBOL	DESCRIPTION
V <sub>CC</sub>	Positive supply to control logic and gate drivers. De-couple this pin to GND.
V <sub>IN</sub>	FET Switch Input Voltage. De-couple this pin to GND.
PHASE	Output.
PWM (HIP5015) $\overline{\text{PWM}}$ (HIP5016)	Single Ended Control Input. This input connects to the PWM controller output.
GND	System Ground.

## Timing Diagram

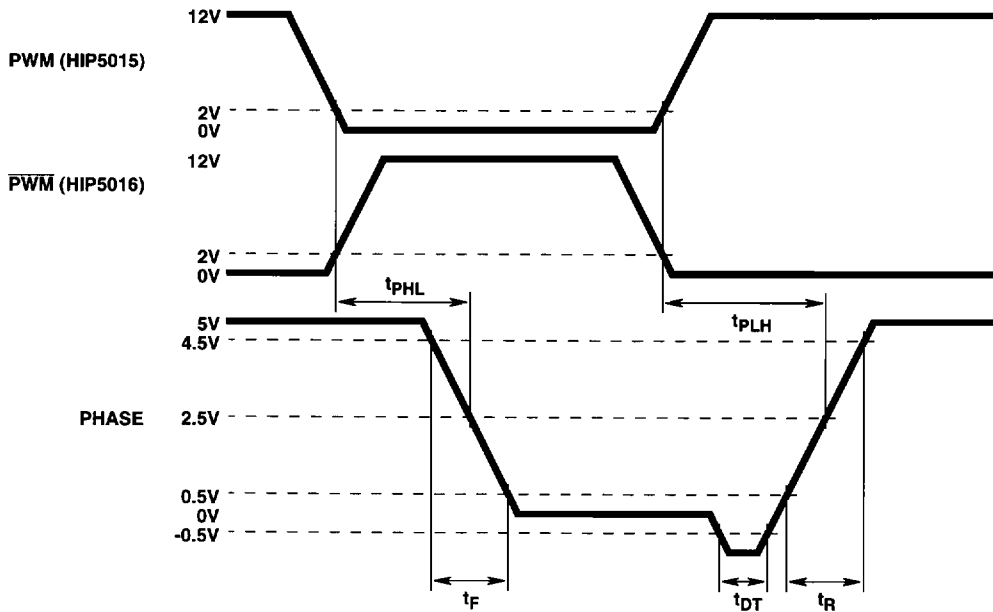

NOTE: I<sub>PHASE</sub> = +0.5A for t<sub>PLH</sub> and t<sub>F</sub>. I<sub>PHASE</sub> = -0.5A for t<sub>PHL</sub>, t<sub>DT</sub>, and t<sub>R</sub>.

FIGURE 1.

Typical Performance Curves

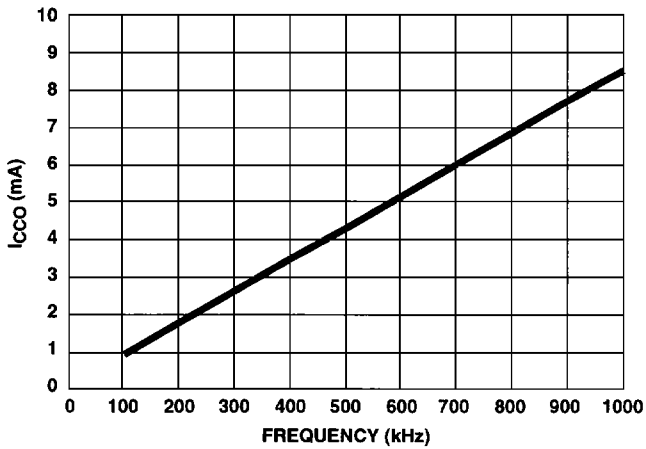

FIGURE 2. I<sub>CCO</sub> vs FREQUENCY

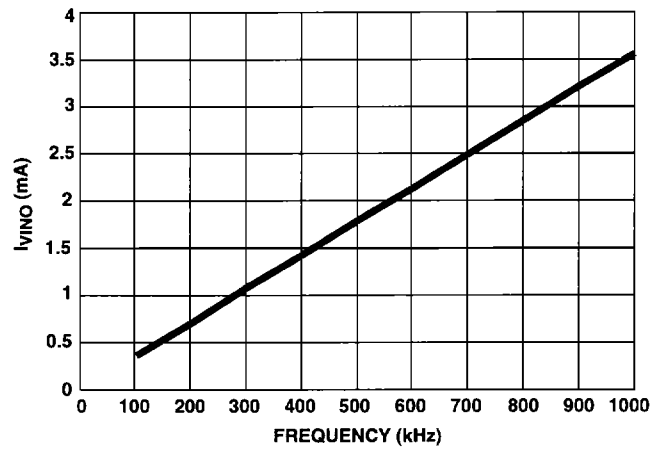

FIGURE 3. I<sub>VINO</sub> vs FREQUENCY

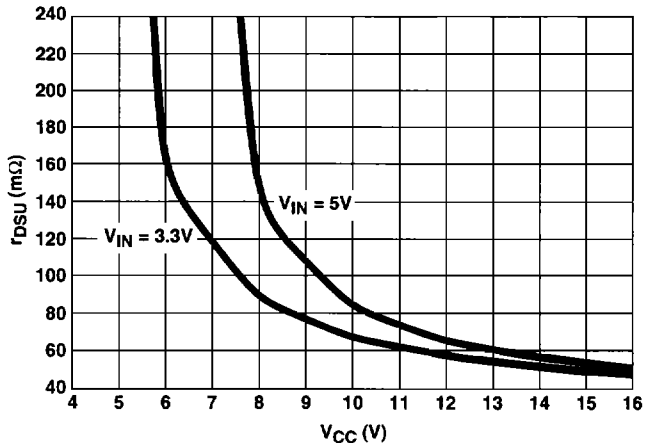

FIGURE 4. R<sub>DSU</sub> vs V<sub>Cc</sub>

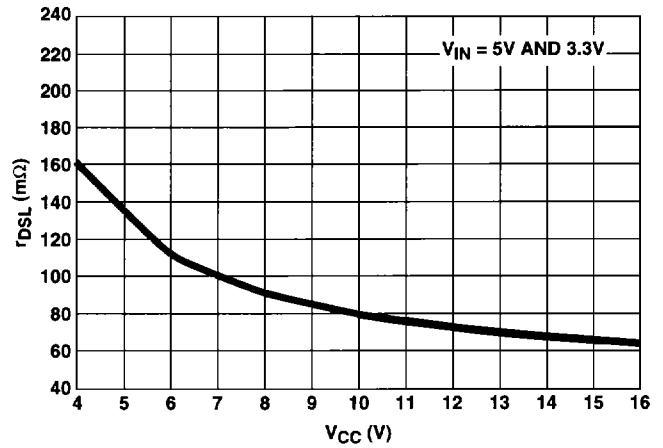

FIGURE 5. R<sub>DSL</sub> vs V<sub>Cc</sub>

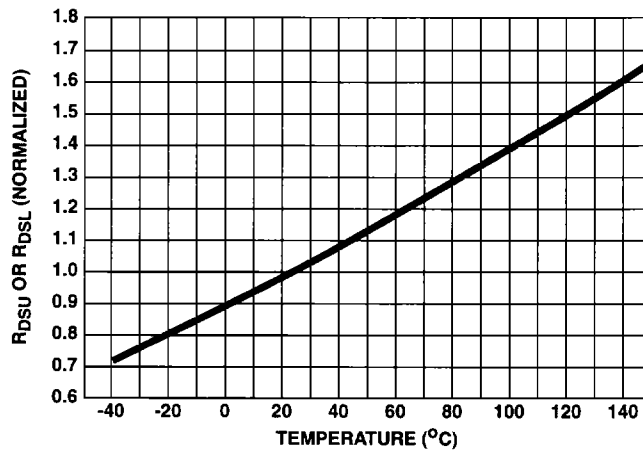
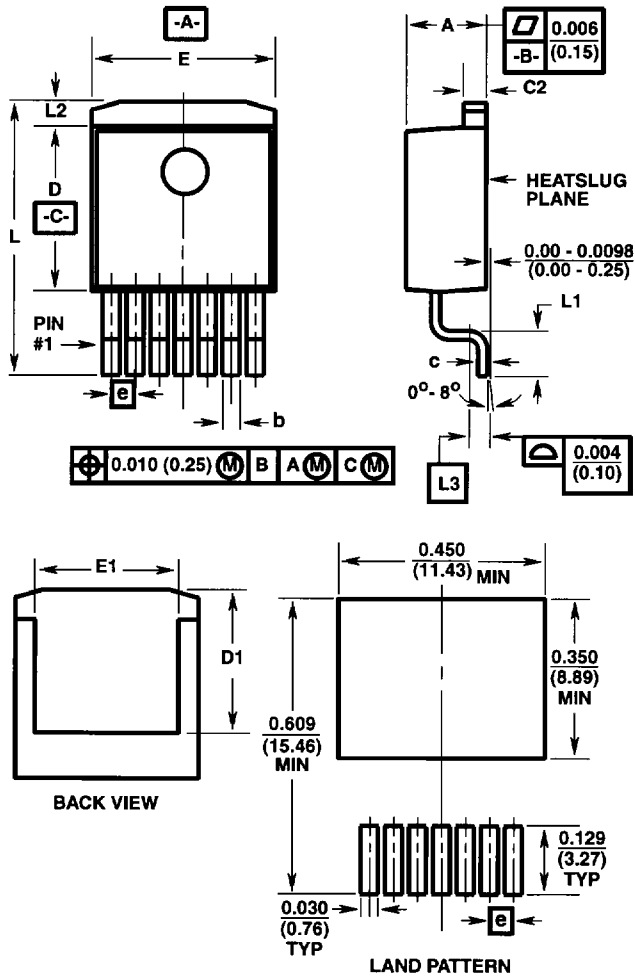

FIGURE 6. R<sub>DSU</sub> OR R<sub>DSL</sub> vs TEMPERATURE

HIP5015, HIP5016

Single-In-Line Plastic Packages (SIP)



Z7.05B

7 LEAD PLASTIC SINGLE-IN-LINE PACKAGE SURFACE MOUNT  
"GULLWING" LEAD FORM

SYMBOL	INCHES		MILLIMETERS		NOTES
	MIN	MAX	MIN	MAX	
A	0.170	0.180	4.32	4.57	-
C2	0.048	0.055	1.22	1.39	5
D	0.350	0.370	8.89	9.39	-
E	0.395	0.405	10.04	10.28	-
D1	0.310	-	7.88	-	-
E1	0.310	-	7.88	-	-
L	0.549	0.569	13.95	14.45	-
L1	0.068	0.088	1.72	2.24	-
L2	0.045	0.055	1.15	1.40	-
L3	0.030 BSC		0.76 BSC		4
b	0.028	0.034	0.71	0.86	5, 6, 7
c	0.018	0.024	0.46	0.60	5
e	0.050 BSC		1.27 BSC		-

Rev. 2 12/95

NOTES:

1. These package dimensions are within allowable dimensions of JEDEC MO-169AC, Issue A.
2. Controlling dimension: Inch.
3. Dimensioning and tolerance per ANSI Y14.5M-1982.
4. Gauge plane L3 is parallel to heatslug plane.
5. Dimensions include lead finish.
6. Leads are not allowed above the datum **-B-**.
7. Dimension "b" does not include dambar protrusion. Allowable dambar protrusion shall not cause the lead width to exceed the maximum "b" by more than 0.003" (0.08mm).

**Single-In-Line Plastic Packages (SIP)**

**Z7.05C**  
**7 LEAD PLASTIC SINGLE-IN-LINE PACKAGE**  
**STAGGERED VERTICAL LEAD FORM**

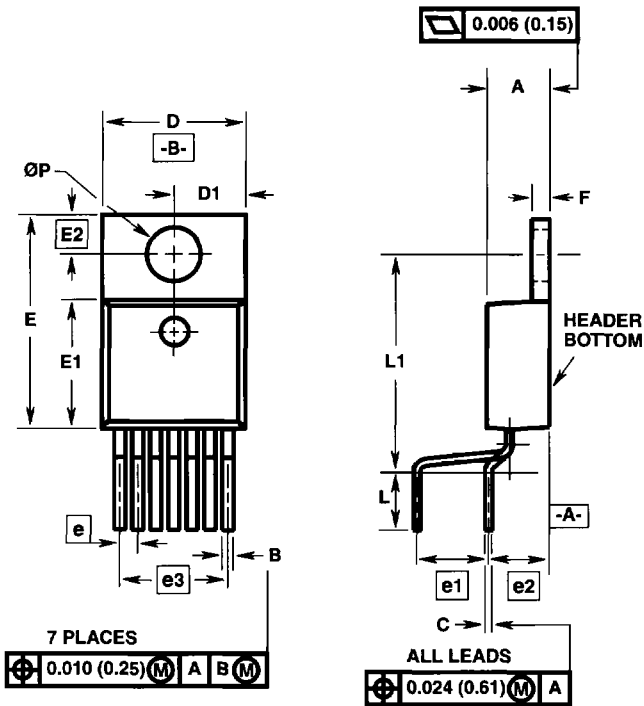

SYMBOL	INCHES		MILLIMETERS		NOTES
	MIN	MAX	MIN	MAX	
A	0.170	0.180	4.32	4.57	-
B	0.028	0.034	0.71	0.86	3, 4
C	0.018	0.024	0.46	0.60	3
D	0.395	0.405	10.04	10.28	-
D1	0.198	0.202	5.03	5.13	-
E	0.595	0.605	15.11	15.37	-
E1	0.350	0.370	8.89	9.39	-
E2	0.110 BSC		2.79 BSC		
e	0.050 BSC		1.27 BSC		-
e1	0.200 BSC		5.08 BSC		-
e2	0.169 BSC		4.29 BSC		-
e3	0.300 BSC		7.62 BSC		-
F	0.048	0.055	1.22	1.39	3
L	0.150	0.176	3.81	4.47	-
L1	0.600	0.620	15.24	15.74	-
$\varnothing P$	0.147	0.152	3.73	3.86	3

Rev. 0 6/95

NOTES:

1. Controlling dimension: INCH.
2. Dimensioning and tolerancing per ANSI Y14.5M-1982.
3. Dimensions include lead finish.
4. Dimension "B" does not include dambar protrusion. Allowable dambar protrusion shall not cause lead width to exceed maximum "B" by more than 0.003 inches (0.08mm).

All Harris Semiconductor products are manufactured, assembled and tested under **ISO9000** quality systems certification.

Harris Semiconductor products are sold by description only. Harris Semiconductor reserves the right to make changes in circuit design and/or specifications at any time without notice. Accordingly, the reader is cautioned to verify that data sheets are current before placing orders. Information furnished by Harris is believed to be accurate and reliable. However, no responsibility is assumed by Harris or its subsidiaries for its use; nor for any infringements of patents or other rights of third parties which may result from its use. No license is granted by implication or otherwise under any patent or patent rights of Harris or its subsidiaries.

**Sales Office Headquarters**

For general information regarding Harris Semiconductor and its products, call **1-800-4-HARRIS**

**NORTH AMERICA**

Harris Semiconductor  
P. O. Box 883, Mail Stop 53-210  
Melbourne, FL 32902  
TEL: 1-800-442-7747  
(407) 729-4984  
FAX: (407) 729-5321

**EUROPE**

Harris Semiconductor  
Mercure Center  
100, Rue de la Fusee  
1130 Brussels, Belgium  
TEL: (32) 2.724.2111  
FAX: (32) 2.724.22.05

**ASIA**

Harris Semiconductor PTE Ltd.  
No. 1 Tannery Road  
Cencon 1, #09-01  
Singapore 1334  
TEL: (65) 748-4200  
FAX: (65) 748-0400

