



RoHS

KPPX/KPJX Series

Snap and Lock PCB and Cable Mount

Features 

- Laptop Computers, Power Supplies and Other Portable Digital Equipment Applications
- Snap and Lock Feature Helps to Prevent Accidental Disconnects
- 3 or 4 Pins Transmit Power, or One Pin Can be Used For Signal Transmission
- For Signal and DC Power Applications
- Plugs Supplied in Kits Ready for Assembly
- CSA/NRTL Certified File No. LR78160

Performance Specifications

Materials and Finish

Jack

Shield: Tin Plated

Body: PBT UL94 V-0 Rated

HT Body: High Temperature Thermoplastic, UL94 V-0 Rated

Plug

Body: ABS, UL 94HB Rated

Insert: Nylon, UL 94HB Rated

Electrical Characteristics

Contact Rating

3 Position: Pin 1 and 2, 24V DC at 7.5A Max.,
Pin 3, 24V DC 1.0A Max.

4 Position: 24V DC 7.5A Max. for all Pins

Insulation Resistance: 50 Megohms Min. at 250V DC

Dielectric Withstanding Voltage: 500V AC for 1 Minute

Contact Resistance: 30 milliohms Max.

Mechanical Characteristics

Durability Test: 1000 Cycles

Suggested Wire Awg.: #18 for Power Wires, #24 for Signal Wire

DC POWER CONNECTORS

KPJX / KPPX Series

Ordering Information

Series	Mounting Option	No of Contacts	Contact Type	Shield Option
--------	-----------------	----------------	--------------	---------------

Series

KPJX - Right Angle Receptacle
 KPJX-CM - Receptacle, Cable Mount
 KPJX-PM - Receptacle, Panel Mount
 KPJXHT - High Temp Right Angle Receptacle
 KPPX - Snap and Lock DC Power Plug Cable Mount

Number of Contacts

3 Pin
 4 Pin

Contact Type

S - Socket (KPJX Only)
 P - Plug (KPPX Only)

Shield Option

Blank - Non-Shielded
 S - Shielded (KPJX, KPJX-PM and KPJXHT only)

KPJX-3S

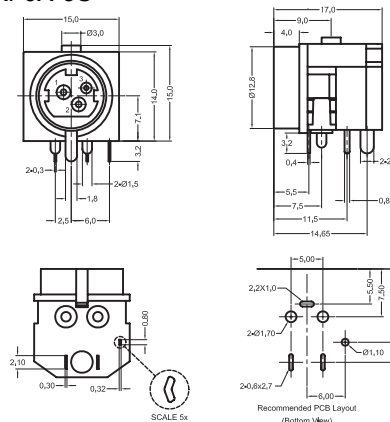

KPPX-xP

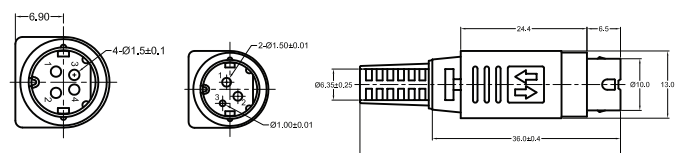

KPJX-CM-xS

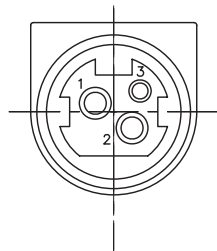

3 PIN CONFIGURATION

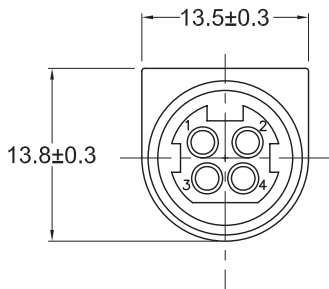

4 PIN CONFIGURATION

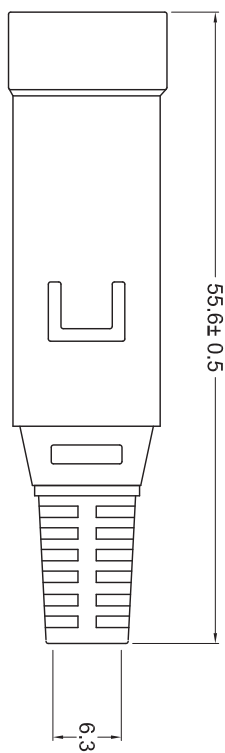

KPJX-PM-3S

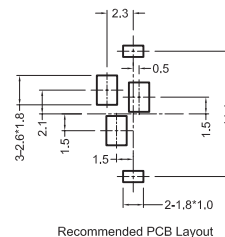
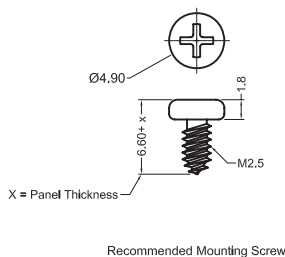
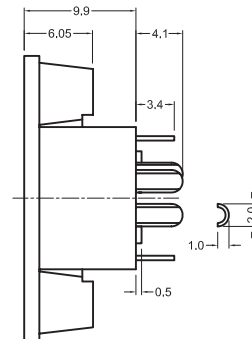
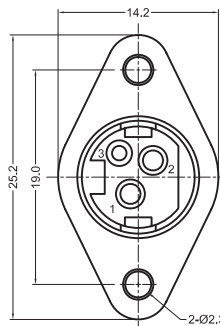

KPJX-PM-4S

