

Inverter Transformers

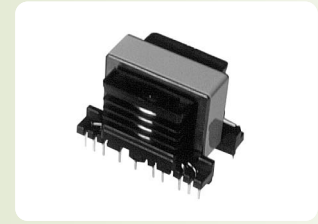

Outline

These transformers with a double-bobbin configuration are manufactured using automated coil winding and standardized manufacturing processes, thereby assuring quality and reducing cost. NEC TOKIN offers transformers for inverters that have gained wide use not only in factories, but also in normal households.

Features

- Low cost
- High-reliability
- Multi-outputs

Applications

- Power supplies for inverter controller

Model	Output		Insulation AC Withstand Voltage [primary-to-secondary for 1 minute] (V)
	Maximum Power (W)*	Number of Circuits	
IVT-28P	15	7	1500
IVT-33P18	18	8	1500
IVT-33P22	18	12	1500

*Maximum power: Ringing Choke Converter Method (f = 30kHz)

Shapes and Dimensions

●IVT-28P

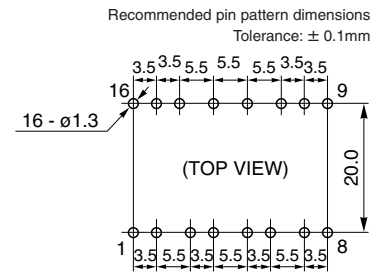
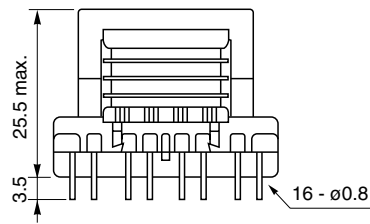
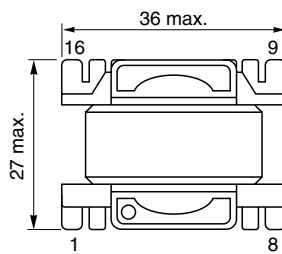

●IVT-33P18

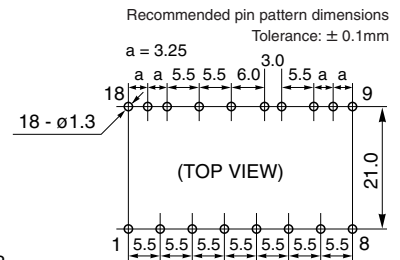
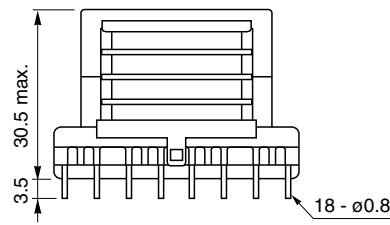
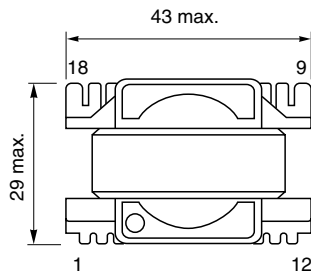

[mm]

Shapes and Dimensions

● IVT-33P22

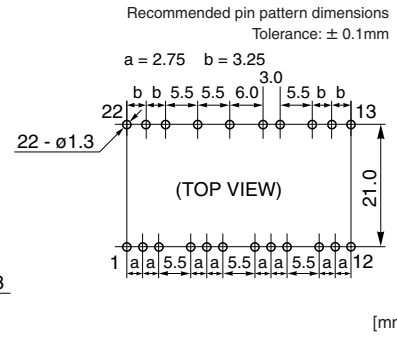
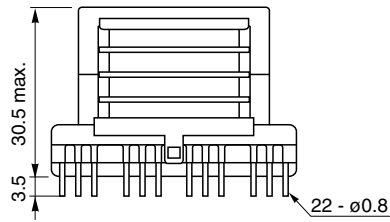
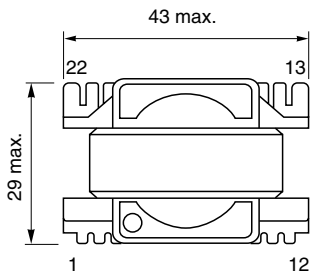

Circuit Example

● IVT-28P

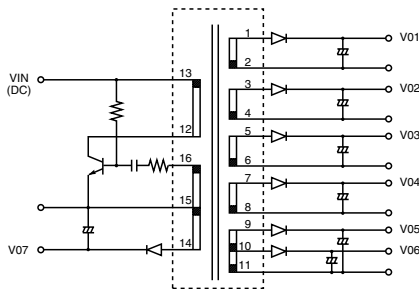

● IVT-33P18

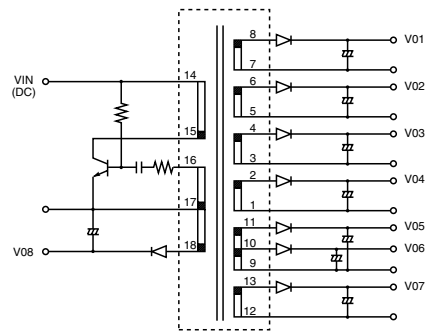

● IVT-33P22

