

13651DE

13 Gbps Differential Encoder

Data Sheet

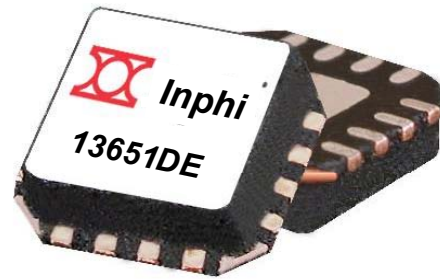

Applications

- High-speed (up to 13 Gbps) optical duobinary systems
- High-speed (up to 13 Gbps) optical differential phase shift keying systems (DPSK)
- High-speed (up to 13 GHz) digital logic
- Broadband test and measurement equipment

Features

- Supports data rates up to 13 Gbps
- Fast rise and fall times typically 15 ps
- Low power consumption: 380 mW
- 290° input phase margin (at 12.5 Gbps)
- Supports single-ended and differential operation
- Output signal swing 1200 mV_{pp} differential
- Single +3.3 V power supply
- Available in plastic QFN package
- Evaluation board available

Description

The 13651DE differential encoder performs modulo two addition of the input data bit with the previous output bit. The part operates up to 13 Gbps and retimes the input data before performing the encoding operation, thereby providing a large input phase margin.

The encoder is nominally positive-edge triggered; however, by reversing the positive and negative clock connections, a negative-edge triggered application can be accommodated.

All differential data and differential clock inputs are on-chip DC coupled and terminated with 50 Ω resistors to V_{CC} . For direct-coupled applications,

the differential data outputs should be terminated off chip with 50 Ω resistors to V_{CC} (+3.3 V). For applications requiring termination to DC levels other than V_{CC} (i.e. ground referenced systems), external AC coupling to a good RF ground is required. See the application note for various termination examples.

The 13651DE operates from a single +3.3 V power supply and dissipates only 380 mW. It is available in a 3 x 3 mm² quad flat no-lead (QFN) plastic package and is also available on an evaluation board with SMA connectors.

Block Diagram

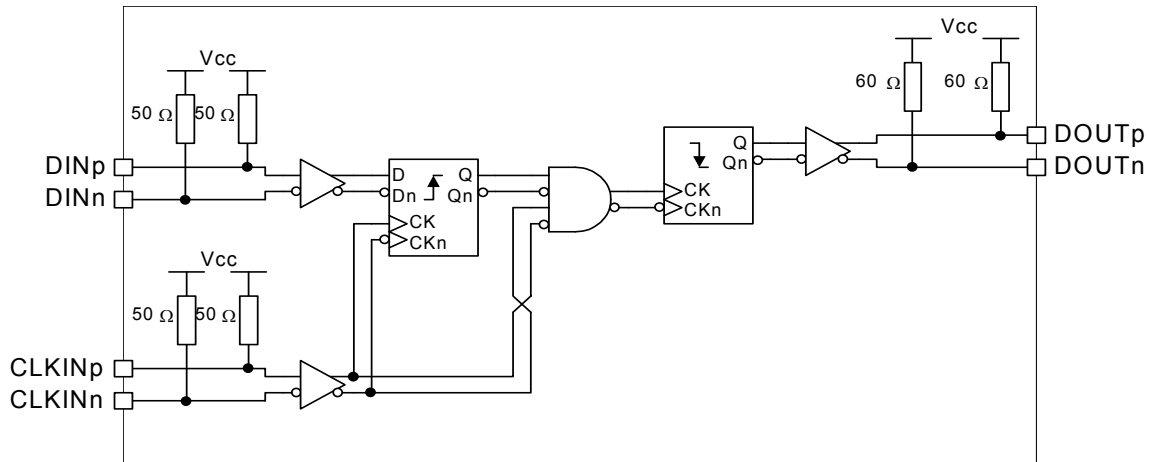

Absolute Maximum Ratings

- Stresses beyond those listed here may cause permanent damage to the device.
- These are stress ratings only. Functional operation of the device at these or any other conditions beyond those indicated in the "Operating Conditions" and "Electrical Specifications" of this datasheet is not implied.
- Exposure to absolute maximum rating conditions for extended periods may affect device reliability.

Parameter	Symbol	Conditions	Min	Max	Unit
Power Supply Voltage	V_{CC}		-0.5	+3.6	V
Input Signals (Data & Clock)			$V_{CC}-2$	$V_{CC}+1$	V
Output Signals			$V_{CC}-2$	$V_{CC}+1$	V
Junction Temperature– Die	T_J		-5	+175	°C
Case Temperature– Package paddle	T_C		-15	+125	°C
Shipping/Storage Temperature	T_{STORE}		-40	+125	°C
Humidity	RH		0	100	%
ESD Protection (Human Body Model)	ESD	Clock and Data inputs	500	---	V
		Data outputs	250	---	V
		Power Supply	500	---	V

Operating Conditions

Parameter	Symbol	Conditions	Min	Typ	Max	Unit
Power Supply Level	V_{CC}	$\pm 5\%$ Tolerance	3.135	3.300	3.465	V
On-Chip Power Dissipation	P_D		---	380	500	mW
Power Supply Current	I_{CC}		---	110	144	mA
Operating Temperature (Junction) – Die	T_J		+15	---	+125	°C
Operating Temperature (Case) – Package	T_C		-5	---	+85	°C
Thermal Resistance – junction to paddle	$R_{JC} (\theta_{JC})$	Bottom of paddle	---	51	---	°C/W

Electrical Specifications



WARNING – To prevent damage to the part:

- DC power must be turned off prior to connecting or disconnecting any cables.

Electrical specifications guaranteed when the part is operated within the specified operating conditions.						
Parameter	Symbol	Conditions	Min	Typ	Max	Unit
Maximum Data Rate		10 ⁻¹² BER (NRZ format)	13	---	---	Gbps
Maximum Clock Frequency	f _{MAX}		13	---	---	GHz
Minimum Clock Slew Rate	S _{MIN}	At CLKIN _p /CLKIN _n crossing	---	---	1	V/ns
Input High Level (Data & Clock)	V _{IH}		V _{CC} -0.5	---	V _{CC} +0.5	V
Input Low Level (Data & Clock)	V _{IL}		V _{CC} -1.0	---	V _{CC}	V
Input Amplitude (Data & Clock)	VIN _{pp} , VCLK _{pp}	Differential peak-to-peak	300	---	2000	mV _{pp}
		Single ended peak-to-peak	300	---	1000	mV _{pp}
Input Return Loss (Data) ¹	RL _{IN}	< 13 GHz; Input common mode < 0.0 V	10	---	---	dB
		< 13 GHz; Input common mode < + 0.5 V	6			dB
Input Return Loss (Clock) ¹	RL _{IN}	< 13 GHz	10			dB
Clock Phase Margin	CPM	At 12.5 Gbps	255	290	---	deg
Data Output Amplitude ²	VOU _{Tpp}	Differential peak-to-peak	900	1200	1400	mV _{pp}
Output High Voltage	V _{OH}	DC coupled, V _{CC} referenced	V _{CC} -50	V _{CC} -4	V _{CC}	mV
Output Low Level	V _{OL}	DC coupled, V _{CC} referenced	V _{CC} -700	V _{CC} - 600	V _{CC} - 450	mV
Output Common Mode	V _{OCM}	DC coupled, V _{CC} referenced	---	V _{CC} -300	---	mV
Output Rise/Fall Time	t _r /t _f	20 – 80%	---	15	25	ps
Output Return Loss ³	RL _{OUT}	< 13 GHz	10	---	---	dB
Deterministic Jitter ^{4,5}	J _D	Peak-to-peak	---	2	4	ps
Random Jitter ^{4,5}	J _R	RMS	---	0.2	0.4	ps
Clock-to-Data Output Delay ^{4,6}	t _Q	Package	50	65	80	Ps
Set-up Time ^{6,7}	t _{set}	Measured at package pins	12	8		Ps
Hold Time ^{6,7}	t _{hold}	Measured at package pins	12	8		ps

Notes:

¹ Inputs are designed to be a broadband match to a 50 Ω impedance and are terminated with a 50 Ω resistor to V_{CC}.

² Outputs are CML. Values given are based on DC measurements.

³ Outputs are designed to be a broadband match to a 50 Ω impedance and are terminated with a 60 Ω resistor to V_{CC}.

⁴ Valid when clock-to-data phase is near center of CPM window.

⁵ It should be noted that because the random and deterministic jitter of Inphi's high-speed logic parts are "in the noise" of the measurement techniques used, these specifications are conservative. The deterministic jitter (J_D) specified is the peak-to-peak total jitter measured using a 2³¹-1 PRBS data pattern. The random jitter (J_R) is the RMS jitter measured on a 1010... pattern. The jitter of the source and measurement equipment was not removed from the measured data.

⁶ Values based on design simulations.

⁷ The setup and hold time specifications were determined from phase margin measurements and the assumption, supported by simulation, that Set-up and Hold times are equal to within a picosecond. See timing diagram on page 4.

Timing Diagram

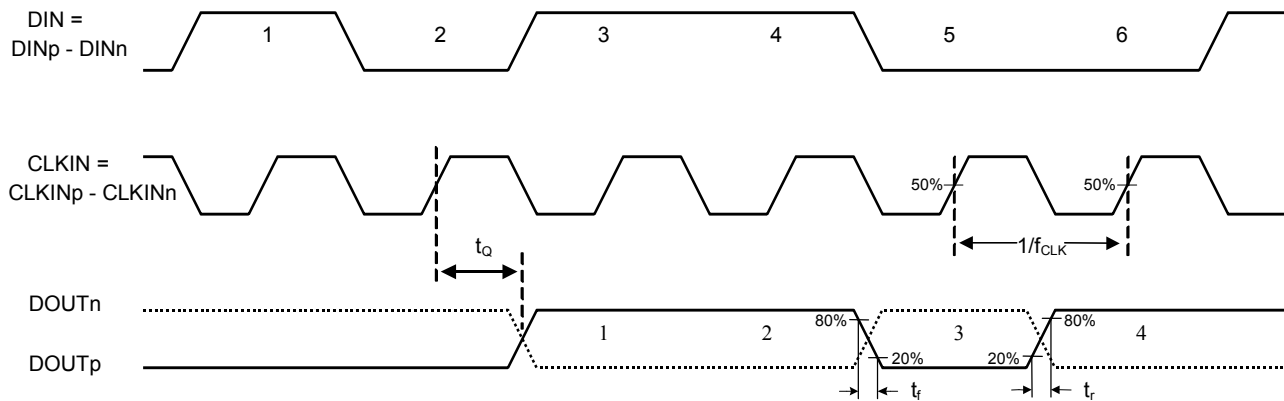

Set-up and Hold Time Definition

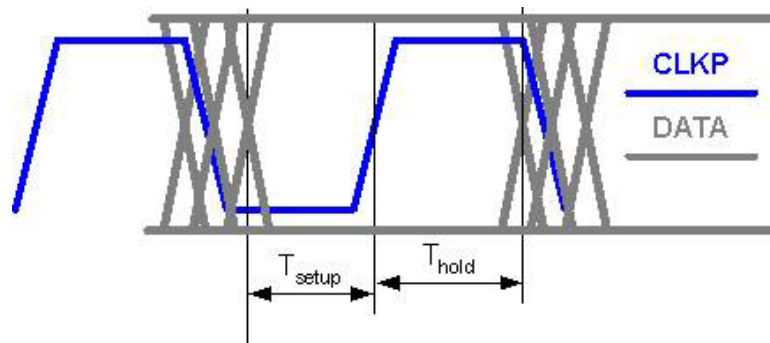

Truth Table

DIN_{k-1}	$DOUT_{k-1}$	$DOUT_k$
0	0	0
0	1	1
1	0	1
1	1	0

$$DOUT_k = DOUT_{k-1} \oplus DIN_{k-1}$$

This equation corresponds to the well-known differential encoder equation $DOUT_k = DOUT_{k-1} \oplus DIN_k$, modified to include a one bit period delay in input data for retiming.

Notes:

$$DIN = DIN_p - DIN_n$$

$$DOUT = DOUT_p - DOUT_n$$

DC Operating Characteristics

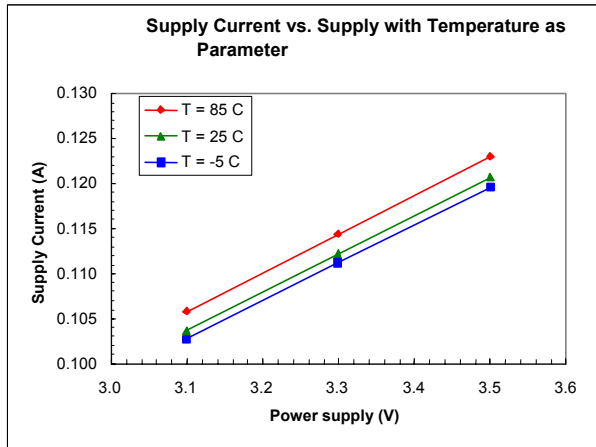

Figure 1. Supply current versus power supply with temperature as parameter

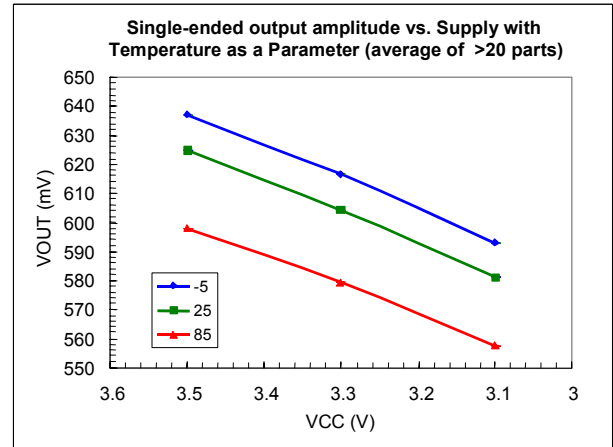

Figure 2. Single-ended peak-to-peak output vs. power supply with temperature as parameter

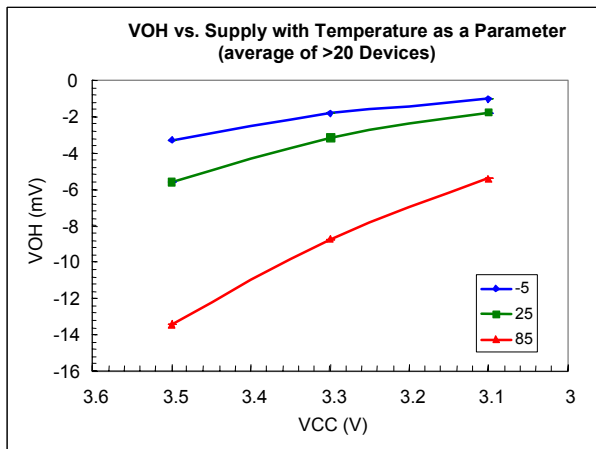

Figure 3. V_{OH} versus power supply with temperature as parameter

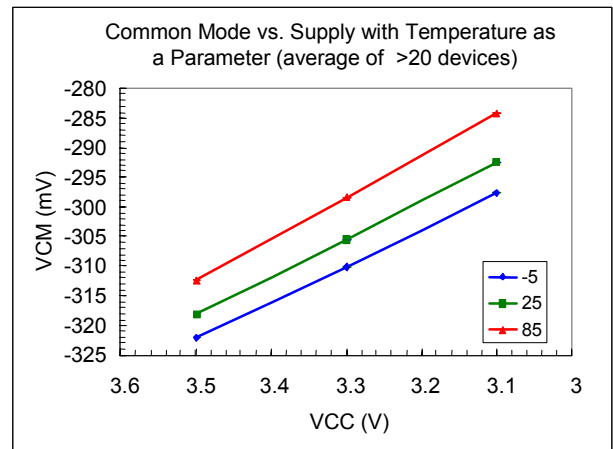

Figure 4. Output common mode vs. power supply with temperature as parameter

Time Domain Operating Characteristics

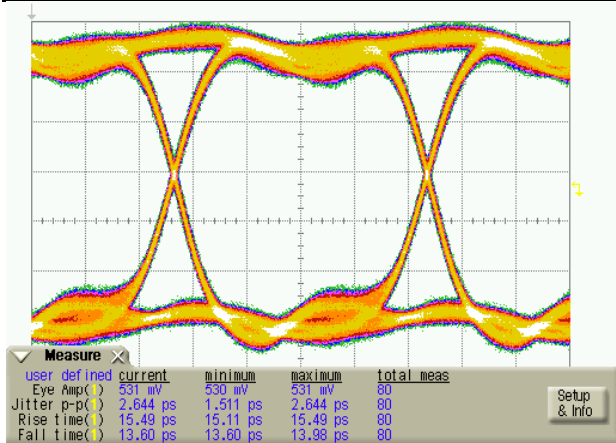

Figure 5. QFN Output eye diagram at 12.5 Gbps, T=25°C; V_{CC}=+3.3 V; Scales: 17 ps/div, 100 mV/div.

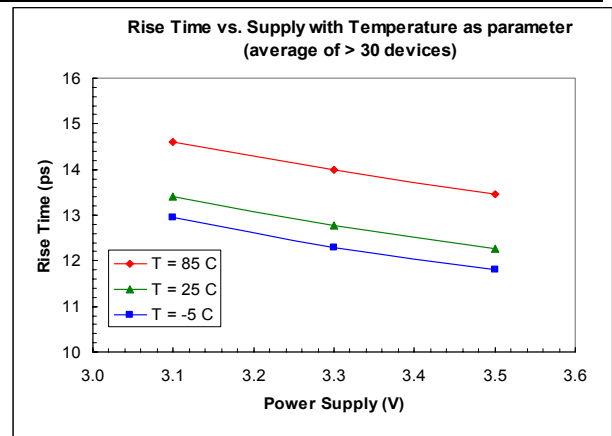

Figure 6. Rise time vs. power supply with temperature as parameter

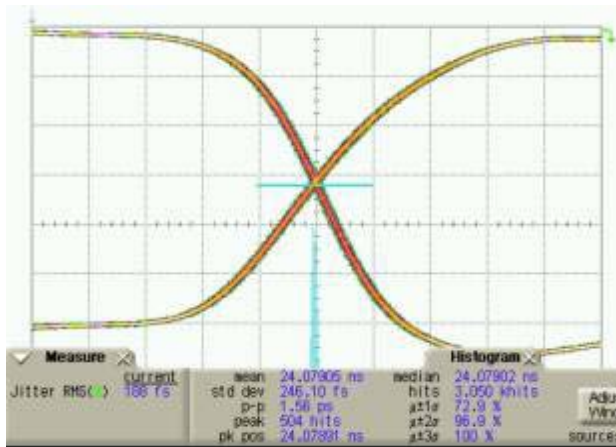

Figure 7. Histogram of output zero-crossing at T=25°C, V_{CC}=3.3V, 1010... pattern; Scales: 17ps/div, 100mV/div.

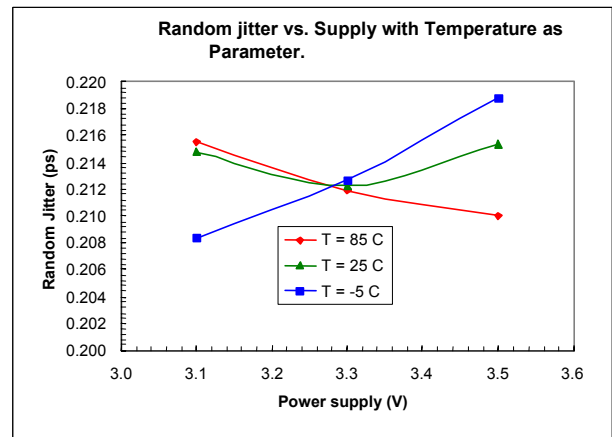

Figure 8. Random jitter vs. power supply with temperature as parameter

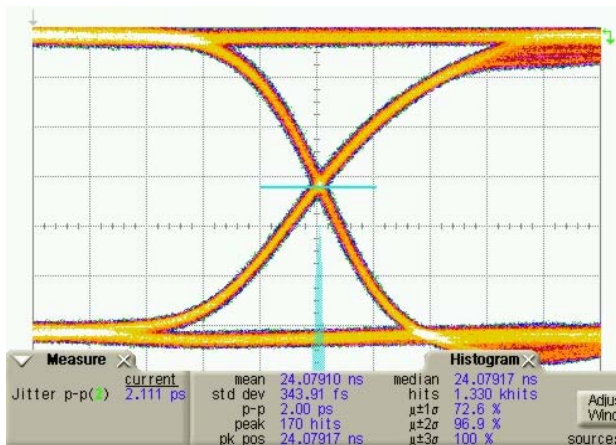

Figure 9. Die output crossing at 12.5 Gbps, T=25°C; V_{CC}=+3.3 V; Scales: 5ps/div, 100mV/div. Histogram used to measure peak-to-peak jitter.

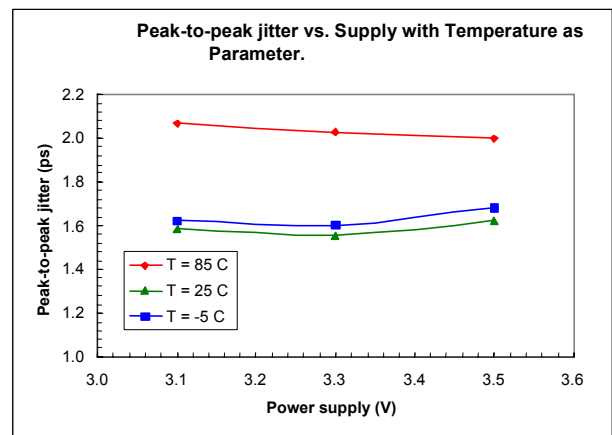

Figure 10. Peak-to-peak jitter vs. power supply with temperature as parameter

Typical Return Losses

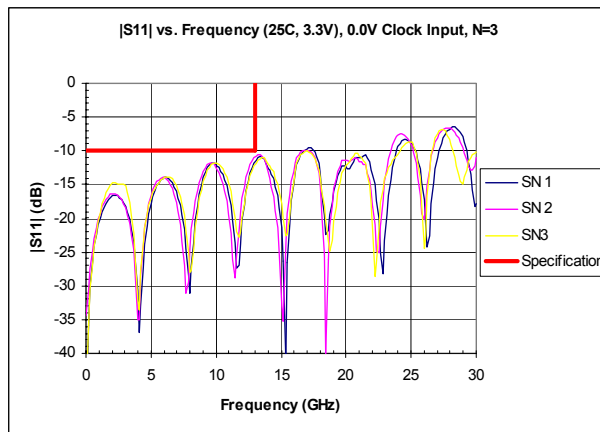

Figure 11. |S11| versus frequency of 3 QFN parts

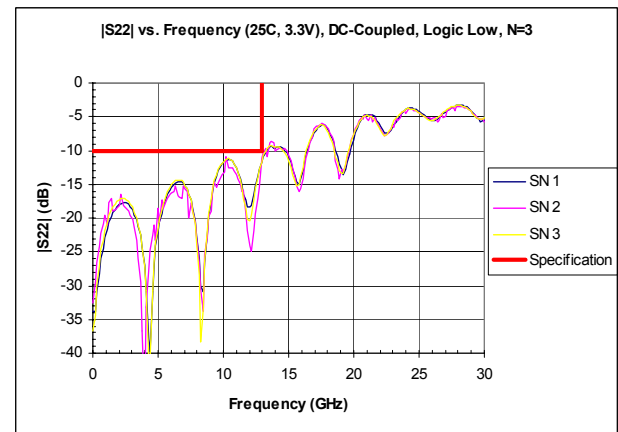

Figure 12. |S22| versus frequency with output in low state (worst case) of 33 parts; Die level data

Clock to Data Phase Margin

The clock to data phase margin is defined in degrees with 360° being a full period of the clock at 12.5 Gbps. It is measured by gradually adjusting the phase of the clock input relative to the data input and looking at the error rate of the differential encoder with a bit error rate tester. As indicated in figure 13, the 13651DE's phase margin is large: typically 290° .

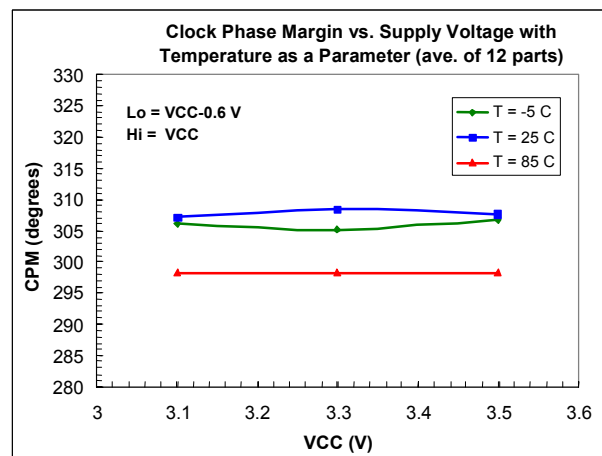
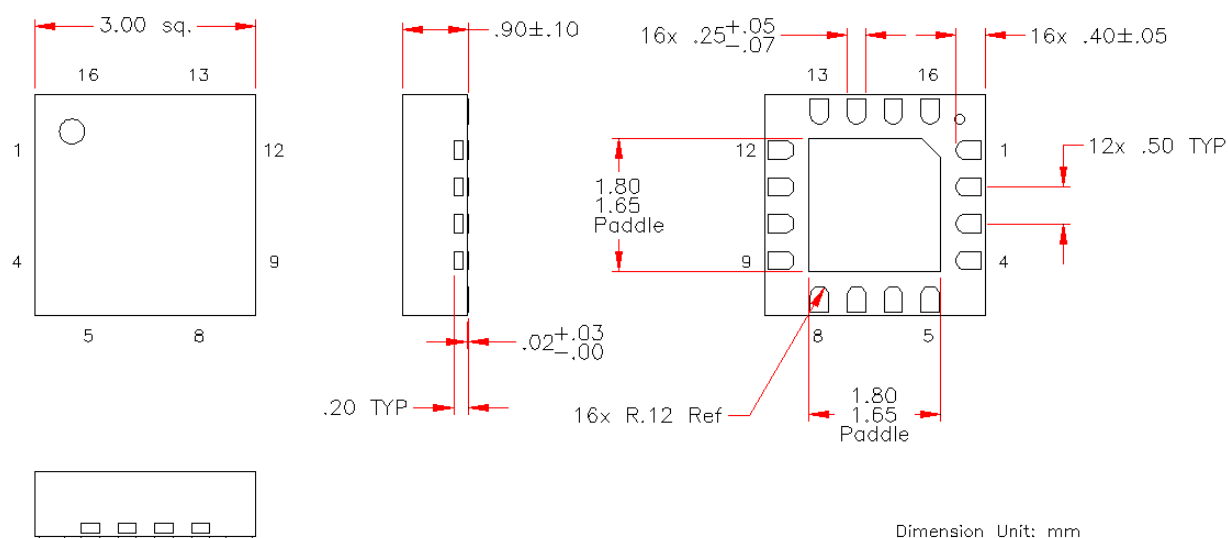

Figure 13. Clock phase margin vs. operating conditions at 12.5 Gbps.

Set-up and Hold Times

Direct measurement of the set-up and hold times is difficult because it involves accurately measuring the electrical delay of the clock and input from signal generators to the package pins and knowledge of the phase between the two signals at their respective generators. Since simulations indicate that the set-up and hold times are equal to within a picosecond, they can be determined from the phase margin. Since the phase margin is typically 290° , the typical set-up and hold times are one half of $70^\circ/360^\circ$ times 80 ps, or 8 ps.

QFN Package Outline Drawing and Pin Assignment



Name	Pin	Description	Function
DIN _p	2	Non-inverting Data Input	Input
DIN _n	3	Inverting Data Input	Input
CLKIN _p	6	Non-inverting Clock Input	Input
CLKIN _n	7	Inverting Clock Input	Input
DOUT _p	11	Non-inverting Data Output	Output
DOUT _n	10	Inverting Data Output	Output
GND	1, 4, 5, 8, 9, 12, 14, Paddle	Ground	Supply
V _{CC}	13, 15, 16	Power Supply: Connect to +3.3 V	Supply

Note:
The paddle must be electrically tied to ground.

Order Information

Part No.	Description
13651DE-S02QFN	13 Gbps Differential Encoder (+3.3 V Supply) in QFN Package
13651DE-S02QFN-EVB	13 Gbps Differential Encoder (+3.3 V Supply) in QFN Package on an Evaluation Board with SMA Connectors

Contact Information

Inphi Corporation
2393 Townsgate Road, Suite 101
Westlake Village, CA 91361

- Phone: (805) 446-5100
- Fax: (805) 446-5189
- E-mail: products@inphi-corp.com

 Visit us on the Internet at: <http://www.inphi-corp.com>

For each customer application, customer's technical experts must validate all parameters. Inphi Corporation reserves the right to change product specifications contained herein without prior notice. No liability is assumed as a result of the use or application of this product. No circuit patent licenses are implied. Contact Inphi Corporation's marketing department for the latest information regarding this product.

Qualification Notification

The 13651DE-S02 is fully qualified. Please contact Inphi for the qualification report.

Inphi Corporation will honor the full warranty as outlined in Section 5 of Inphi's Standard Customer Purchase Order Terms and Conditions.

Version Updates

From Version 1.0 to 1.1 (5/21/06):

1. Added Thermal Resistance to Operating Conditions table (page 2).
2. Electrical Specifications table (page 3):
 - a. Added notes 1 & 3.
 - b. Changed note numbers on parameter descriptions.
3. Qualification Notification section:
 - a. Added statement on radiation tolerance.

From Version 1.1 to 1.2 (dated 2007-06-12):

1. Removed radiation tolerance statement from Qualification Notification section (page 9).