

CNZ1021 (ON1021)

Photo Interrupter

For contactless SW and object detection

■ Overview

CNZ1021 is a transmissive photosensor in which a high efficiency GaAs infrared light emitting diode is used as the light emitting element, and a high sensitivity phototransistor is used as the light detecting element. The two elements are arranged so as to face each other, and objects passing between them are detected.

■ Features

- Highly precise position detection: 0.25 mm
- Gap width: 3 mm
- The type directly attached to PCB

■ Absolute Maximum Ratings $T_a = 25^\circ\text{C}$

Parameter		Symbol	Rating	Unit
Input (Light emitting diode)	Power dissipation *1	P_D	75	mW
	Forward current	I_F	50	mA
	Reverse voltage	V_R	3	V
Output (Photo transistor)	Collector-emitter voltage (Base open)	V_{CEO}	30	V
	Emitter-collector voltage (Base open)	V_{ECO}	5	V
	Collector current	I_C	20	mA
	Collector power dissipation *2	P_C	100	mW
Operating ambient temperature		T_{opr}	-25 to +85	$^\circ\text{C}$
Storage temperature		T_{stg}	-40 to +100	$^\circ\text{C}$

Note) *1: Input power derating ratio is 1.0 mW/ $^\circ\text{C}$ at $T_a \geq 25^\circ\text{C}$

*2: Output power derating ratio is 1.33 mW/ $^\circ\text{C}$ at $T_a \geq 25^\circ\text{C}$

■ Electrical-Optical Characteristics $T_a = 25^\circ\text{C} \pm 3^\circ\text{C}$

Parameter		Symbol	Conditions	Min	Typ	Max	Unit
Input characteristics	Reverse current	I_R	$V_R = 3\text{ V}$			10.0	μA
	Forward voltage	V_F	$I_F = 20\text{ mA}$		1.25	1.4	V
Output characteristics	Collector-emitter cutoff current (Base open)	I_{CEO}	$V_{CE} = 10\text{ V}$		10.0	200	nA
Transfer characteristics	Collector current	I_C	$V_{CC} = 5\text{ V}, I_F = 20\text{ mA}, R_L = 100\ \Omega$	0.5		15.0	mA
	Collector-emitter saturation voltage	$V_{CE(sat)}$	$I_F = 40\text{ mA}, I_C = 1\text{ mA}$			0.4	V
	Rise time *	t_r	$V_{CC} = 5\text{ V}, I_C = 1\text{ mA}, R_L = 100\ \Omega$		5.0		μs
	Fall time *	t_f			5.0		μs

Note) 1. Input and output are practiced by electricity.

2. This device is designed by disregarding radiation.

3. *: Switching time measurement circuit

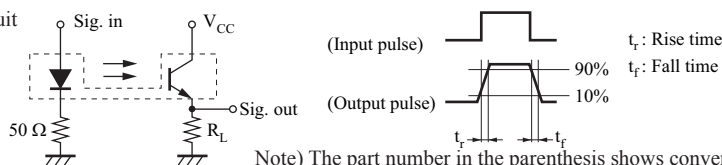

Note) The part number in the parenthesis shows conventional part number.

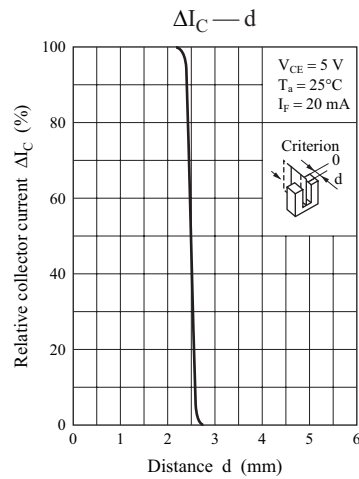
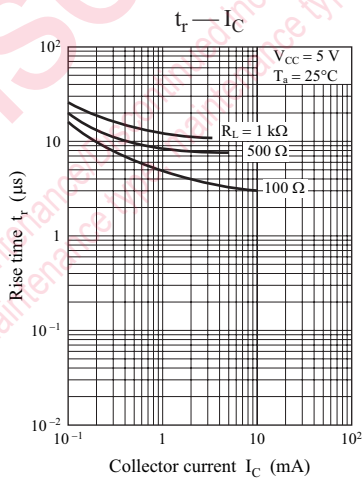
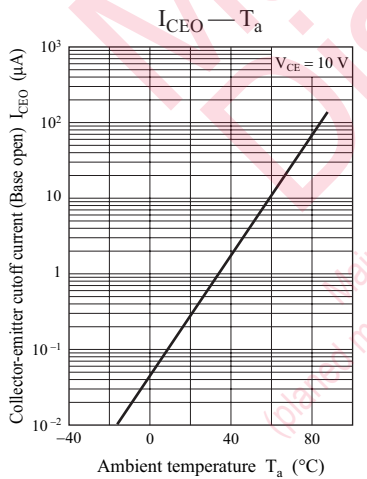
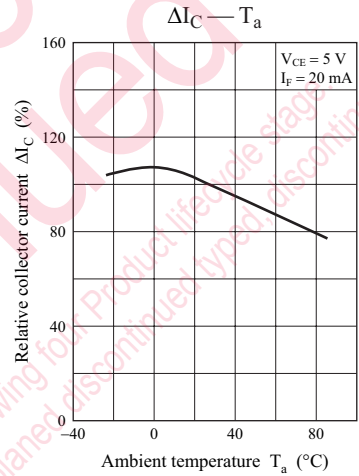
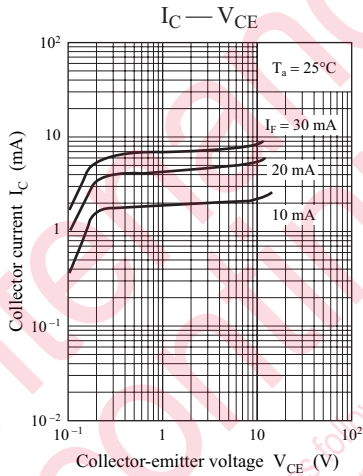
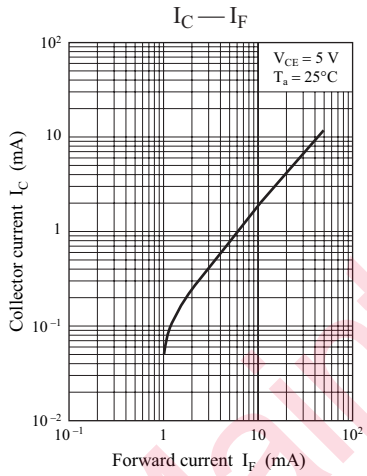
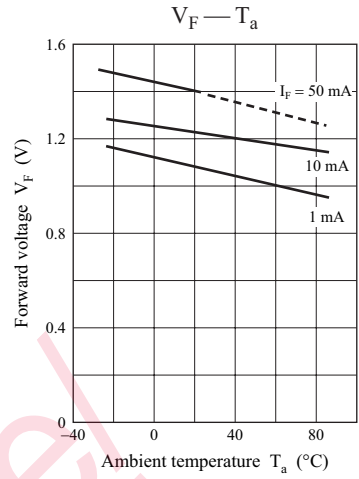
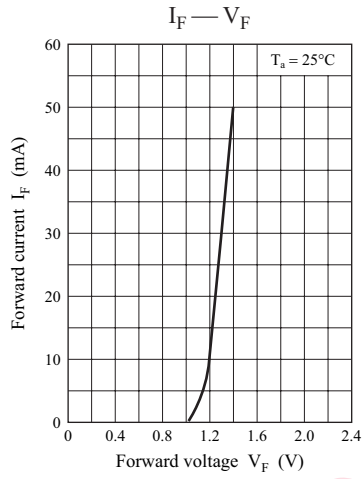
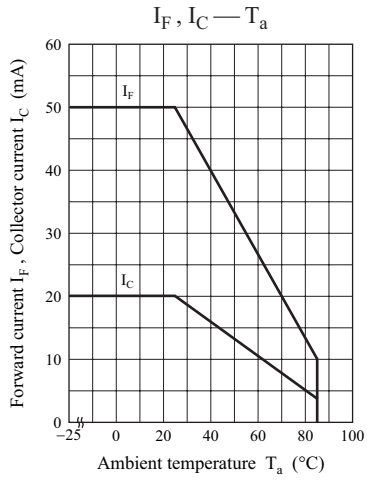

■ Package (Unit: mm)

LSSSIR4S0001

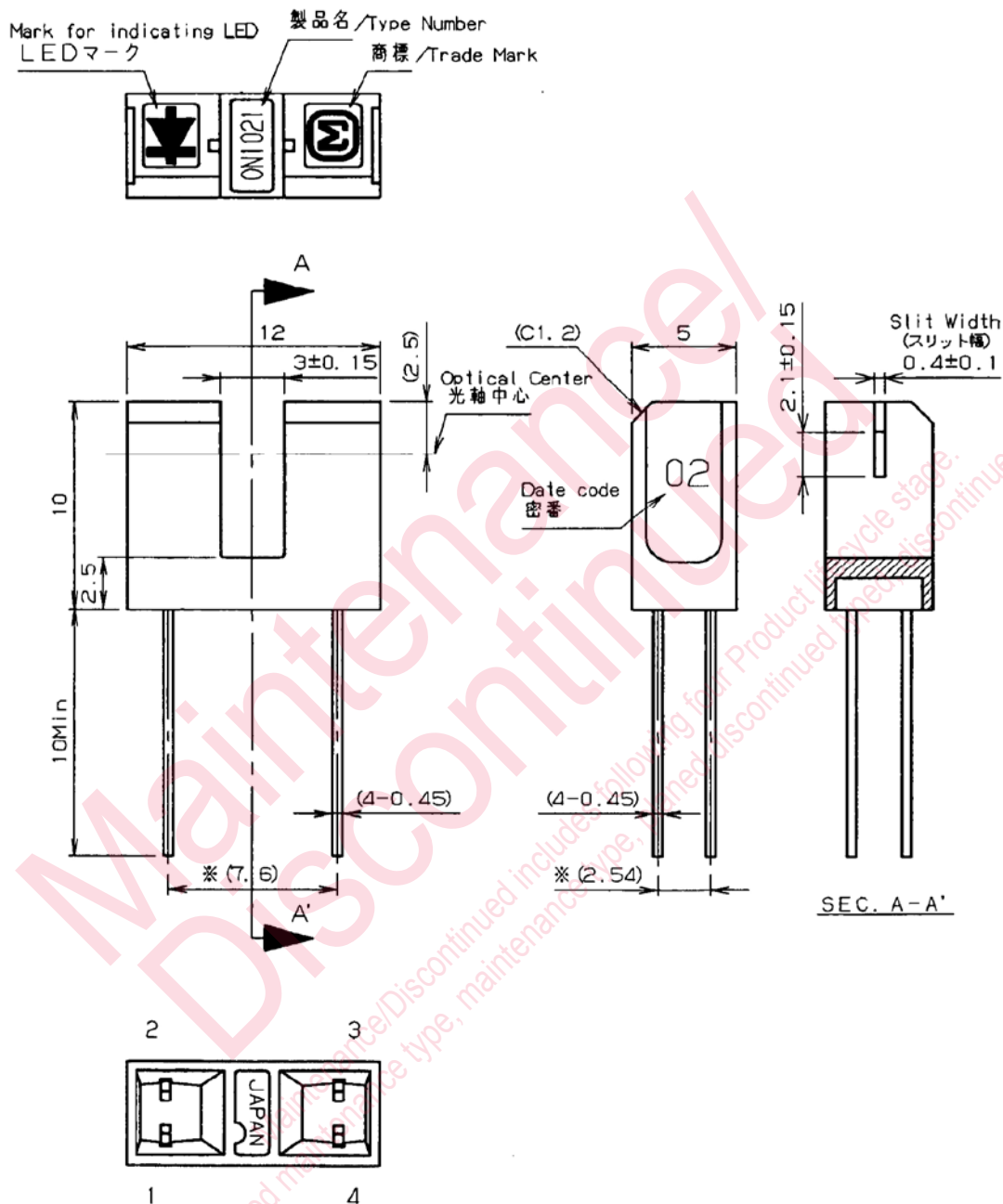

(注1) 指示無き寸法公差: ± 0.3 / (Note1) Not appointment tolerance: ± 0.3
 (注2) () 内寸法は参考値 / (Note2) () A parenthesis measure is reference it.
 (注3) \ast リード根元寸法とする。 (Note3) \ast indicates root dimensions of lead.
 (注4) マークは、目視又は顕微鏡に於いて解読できる事。
 (Note4) What a mark sees an attention and can decode in a microscope.

- Pin name
- 1: Anode
- 2: Cathode
- 3: Collector
- 4: Emitter

Request for your special attention and precautions in using the technical information and semiconductors described in this book

- (1) If any of the products or technical information described in this book is to be exported or provided to non-residents, the laws and regulations of the exporting country, especially, those with regard to security export control, must be observed.
- (2) The technical information described in this book is intended only to show the main characteristics and application circuit examples of the products. No license is granted in and to any intellectual property right or other right owned by Panasonic Corporation or any other company. Therefore, no responsibility is assumed by our company as to the infringement upon any such right owned by any other company which may arise as a result of the use of technical information described in this book.
- (3) The products described in this book are intended to be used for standard applications or general electronic equipment (such as office equipment, communications equipment, measuring instruments and household appliances).
Consult our sales staff in advance for information on the following applications:
 - Special applications (such as for airplanes, aerospace, automobiles, traffic control equipment, combustion equipment, life support systems and safety devices) in which exceptional quality and reliability are required, or if the failure or malfunction of the products may directly jeopardize life or harm the human body.
 - Any applications other than the standard applications intended.
- (4) The products and product specifications described in this book are subject to change without notice for modification and/or improvement. At the final stage of your design, purchasing, or use of the products, therefore, ask for the most up-to-date Product Standards in advance to make sure that the latest specifications satisfy your requirements.
- (5) When designing your equipment, comply with the range of absolute maximum rating and the guaranteed operating conditions (operating power supply voltage and operating environment etc.). Especially, please be careful not to exceed the range of absolute maximum rating on the transient state, such as power-on, power-off and mode-switching. Otherwise, we will not be liable for any defect which may arise later in your equipment.
 - Even when the products are used within the guaranteed values, take into the consideration of incidence of break down and failure mode, possible to occur to semiconductor products. Measures on the systems such as redundant design, arresting the spread of fire or preventing glitch are recommended in order to prevent physical injury, fire, social damages, for example, by using the products.
- (6) Comply with the instructions for use in order to prevent breakdown and characteristics change due to external factors (ESD, EOS, thermal stress and mechanical stress) at the time of handling, mounting or at customer's process. When using products for which damp-proof packing is required, satisfy the conditions, such as shelf life and the elapsed time since first opening the packages.
- (7) This book may be not reprinted or reproduced whether wholly or partially, without the prior written permission of our company.