

National Semiconductor is now part of
Texas Instruments.

Search <http://www.ti.com/> for the latest technical
information and details on our current products and services.

LM556/LM556C Dual Timer

General Description

The LM556 Dual timing circuit is a highly stable controller capable of producing accurate time delays or oscillation. The 556 is a dual 555. Timing is provided by an external resistor and capacitor for each timing function. The two timers operate independently of each other sharing only V_{CC} and ground. The circuits may be triggered and reset on falling waveforms. The output structures may sink or source 200 mA.

Features

- Direct replacement for SE556/NE556
- Timing from microseconds through hours
- Operates in both astable and monostable modes
- Replaces two 555 timers

- Adjustable duty cycle
- Output can source or sink 200 mA
- Output and supply TTL compatible
- Temperature stability better than 0.005% per °C
- Normally on and normally off output

Applications

- Precision timing
- Pulse generation
- Sequential timing
- Time delay generation
- Pulse width modulation
- Pulse position modulation
- Linear ramp generator

Schematic Diagram

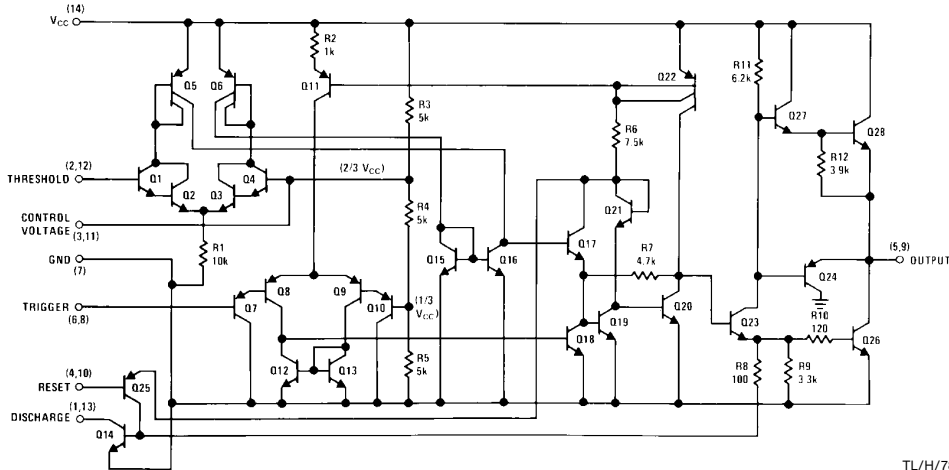

TL/H/7852-2

Connection Diagram

Dual-In-Line and Small Outline Packages

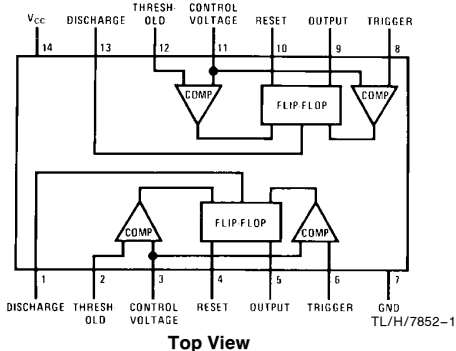

Top View

Order Number LM556J or LM556CJ
See NS Package Number J14A

Order Number LM556CM
See NS Package Number M14A

Order Number LM556CN
See NS Package Number N14A

Absolute Maximum Ratings

If Military/Aerospace specified devices are required, please contact the National Semiconductor Sales Office/Distributors for availability and specifications.

Supply Voltage	+ 18V
Power Dissipation (Note 1)	
LM556J, LM556CJ	1785 mW
LM556CN	1620 mW
Operating Temperature Ranges	
LM556C	0°C to + 70°C
LM556	- 55°C to + 125°C

Storage Temperature Range - 65°C to + 150°C

Soldering Information	
Dual-In-Line Package	
Soldering (10 seconds)	260°C
Small Outline Package	
Vapor phase (60 seconds)	215°C
Infrared (15 seconds)	220°C

See AN-450 "Surface Mounting Methods and Their Effect on Product Reliability" for other methods of soldering surface mount devices.

Electrical Characteristics (T_A = 25°C, V_{CC} = +5V to +15V, unless otherwise specified)

Parameter	Conditions	LM556			LM556C			Units
		Min	Typ	Max	Min	Typ	Max	
Supply Voltage		4.5		18	4.5		16	V
Supply Current (Each Timer Section)	V _{CC} = 5V, R _L = ∞ V _{CC} = 15V, R _L = ∞ (Low State) (Note 2)		3 10	5 11		3 10	6 14	mA mA
Timing Error, Monostable Initial Accuracy Drift with Temperature	R _A = 1k to 100 kΩ, C = 0.1 μF, (Note 3)		0.5 30			0.75 50		% ppm/°C
Accuracy over Temperature Drift with Supply			1.5 0.05			1.5 0.1		% %/V
Timing Error, Astable Initial Accuracy Drift with Temperature Accuracy over Temperature Drift with Supply	R _A , R _B = 1k to 100 kΩ, C = 0.1 μF, (Note 3)		1.5 90 2.5 0.15			2.25 150 3.0 0.30		% ppm/°C % %/V
Trigger Voltage	V _{CC} = 15V V _{CC} = 5V	4.8 1.45	5 1.67	5.2 1.9	4.5 1.25	5 1.67	5.5 2.0	V V
Trigger Current			0.1	0.5		0.2	1.0	μA
Reset Voltage	(Note 4)	0.4	0.5	1	0.4	0.5	1	V
Reset Current			0.1	0.4		0.1	0.6	mA
Threshold Current	V _{TH} = V-Control (Note 5) V _{TH} = 11.2V		0.03	0.1		0.03	0.1	μA nA
Control Voltage Level and Threshold Voltage	V _{CC} = 15V V _{CC} = 5V	9.6 2.9	10 3.33	10.4 3.8	9 2.6	10 3.33	11 4	V V
Pin 1, 13 Leakage Output High			1	100		1	100	nA
Pin 1, 13 Sat Output Low Output Low	(Note 6) V _{CC} = 15V, I = 15 mA V _{CC} = 4.5V, I = 4.5 mA		150 70	240 100		180 80	300 200	mV mV

Electrical Characteristics ($T_A = 25^\circ\text{C}$, $V_{CC} = +5\text{V}$ to $+15\text{V}$, unless otherwise specified) (Continued)

Parameter	Conditions	LM556			LM556C			Units
		Min	Typ	Max	Min	Typ	Max	
Output Voltage Drop (Low)	$V_{CC} = 15\text{V}$							
	$I_{SINK} = 10\text{ mA}$		0.1	0.15		0.1	0.25	V
	$I_{SINK} = 50\text{ mA}$		0.4	0.5		0.4	0.75	V
	$I_{SINK} = 100\text{ mA}$		2	2.25		2	2.75	V
	$I_{SINK} = 200\text{ mA}$		2.5			2.5		V
	$V_{CC} = 5\text{V}$							
Output Voltage Drop (High)	$I_{SOURCE} = 200\text{ mA}$, $V_{CC} = 15\text{V}$		12.5			12.5		V
	$I_{SOURCE} = 100\text{ mA}$, $V_{CC} = 15\text{V}$	13	13.3		12.75	13.3		V
	$V_{CC} = 5\text{V}$	3	3.3		2.75	3.3		V
Rise Time of Output			100			100		ns
Fall Time of Output			100			100		ns
Matching Characteristics	(Note 7)							
Initial Timing Accuracy			0.05	0.2		0.1	2.0	%
Timing Drift with Temperature			± 10			± 10		ppm/ $^\circ\text{C}$
Drift with Supply Voltage			0.1	0.2		0.2	0.5	%/V

Note 1: For operating at elevated temperatures the device must be derated based on a $+150^\circ\text{C}$ maximum junction temperature and a thermal resistance of $70^\circ\text{C}/\text{W}$ (Ceramic), $77^\circ\text{C}/\text{W}$ (Plastic DIP) and $110^\circ\text{C}/\text{W}$ (SO-14 Narrow).

Note 2: Supply current when output high typically 1 mA less at $V_{CC} = 5\text{V}$.

Note 3: Tested at $V_{CC} = 5\text{V}$ and $V_{CC} = 15\text{V}$.

Note 4: As reset voltage lowers, timing is inhibited and then the output goes low.

Note 5: This will determine the maximum value of $R_A + R_B$ for 15V operation. The maximum total ($R_A + R_B$) is 20 M Ω .

Note 6: No protection against excessive pin 1, 13 current is necessary providing the package dissipation rating will not be exceeded.

Note 7: Matching characteristics refer to the difference between performance characteristics of each timer section.

Note 8: Refer to RETS556X drawing for specifications of military LM556J version.

Typical Performance Characteristics

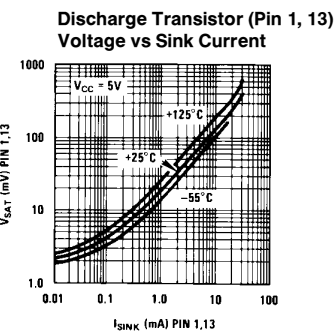
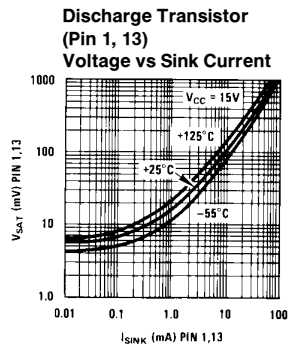
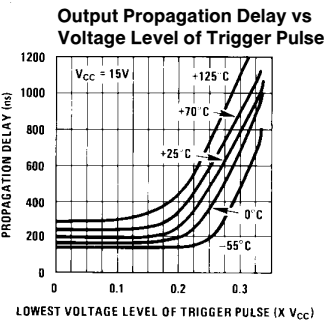
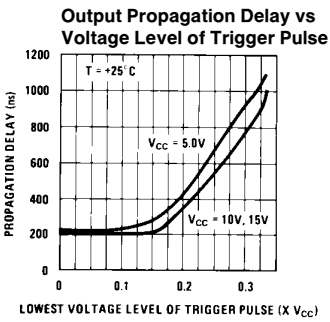
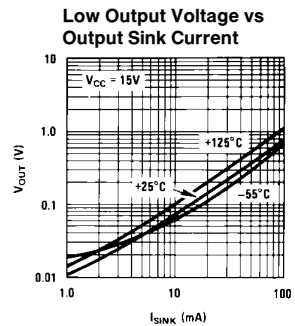
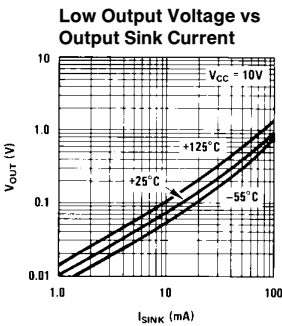
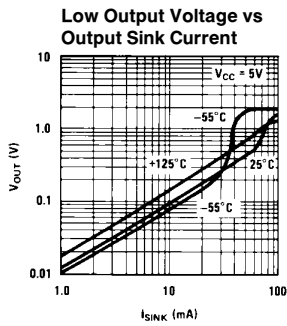
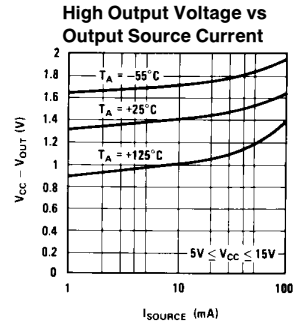
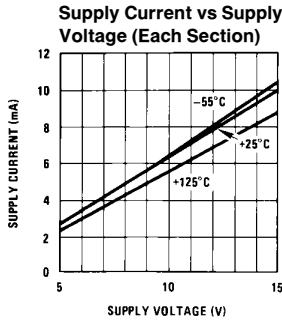
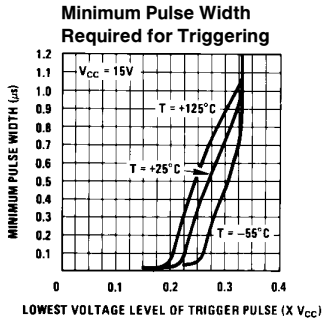

Physical Dimensions inches (millimeters)

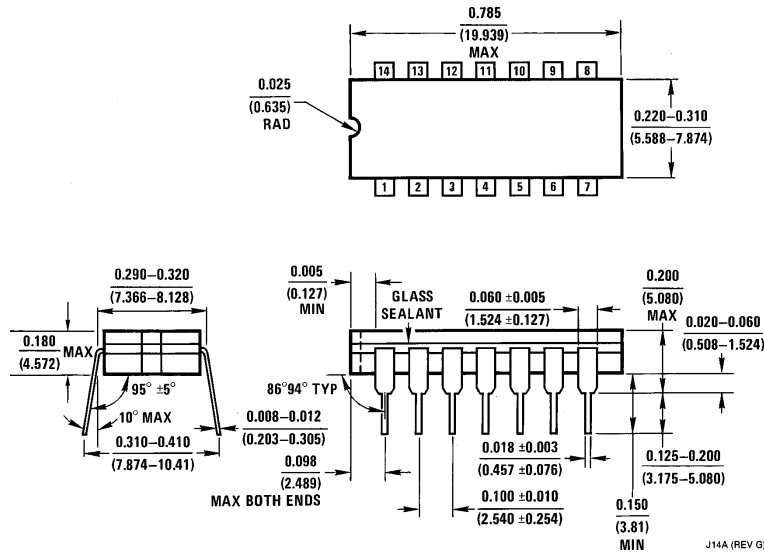

Ceramic Dual-In-Line Package (J)
Order Number LM556J or LM556CJ
NS Package Number J14A

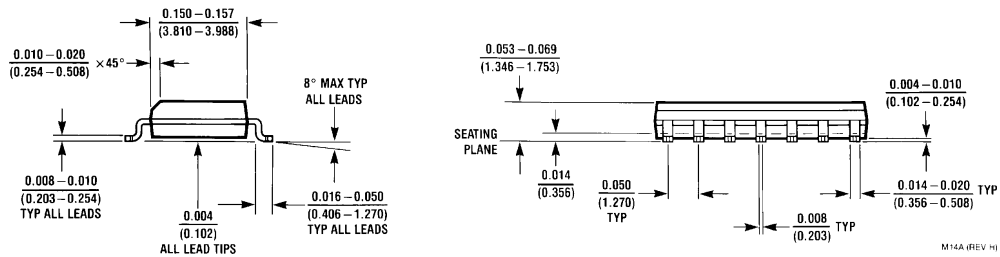
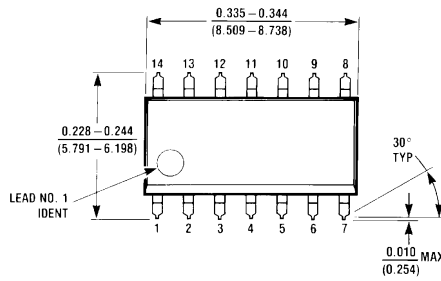

S.O. Molded Package (M)
Order Number LM556CM
NS Package Number M14A

Physical Dimensions inches (millimeters) (Continued)

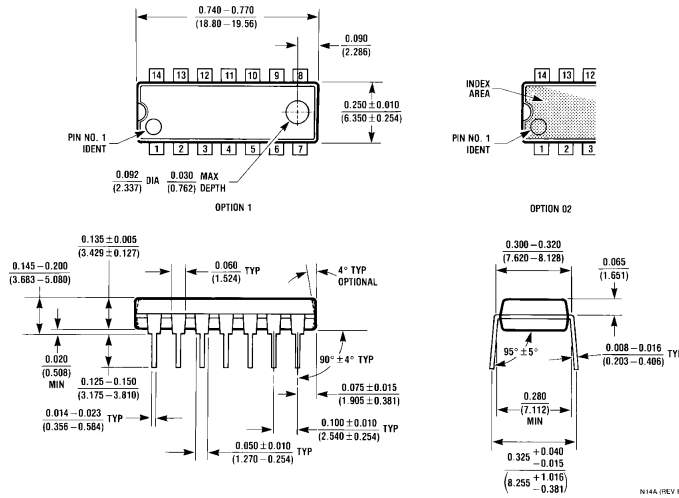

Molded Dual-In-Line Package (N)
Order Number LM556CN
NS Package Number N14A

LIFE SUPPORT POLICY

NATIONAL'S PRODUCTS ARE NOT AUTHORIZED FOR USE AS CRITICAL COMPONENTS IN LIFE SUPPORT DEVICES OR SYSTEMS WITHOUT THE EXPRESS WRITTEN APPROVAL OF THE PRESIDENT OF NATIONAL SEMICONDUCTOR CORPORATION. As used herein:

1. Life support devices or systems are devices or systems which, (a) are intended for surgical implant into the body, or (b) support or sustain life, and whose failure to perform, when properly used in accordance with instructions for use provided in the labeling, can be reasonably expected to result in a significant injury to the user.
2. A critical component is any component of a life support device or system whose failure to perform can be reasonably expected to cause the failure of the life support device or system, or to affect its safety or effectiveness.



National Semiconductor Corporation
 1111 West Bardin Road
 Arlington, TX 76017
 Tel: 1(800) 272-9959
 Fax: 1(800) 737-7018

National Semiconductor Europe
 Fax: (+49) 0-180-530 85 86
 Email: cnjwge@tevm2.nsc.com
 Deutsch Tel: (+49) 0-180-530 85 85
 English Tel: (+49) 0-180-532 78 32
 Français Tel: (+49) 0-180-532 93 58
 Italiano Tel: (+49) 0-180-534 16 80

National Semiconductor Hong Kong Ltd.
 19th Floor, Straight Block,
 Ocean Centre, 5 Canton Rd.
 Tsimshatsui, Kowloon
 Hong Kong
 Tel: (852) 2737-1600
 Fax: (852) 2736-9960

National Semiconductor Japan Ltd.
 Tel: 81-043-299-2309
 Fax: 81-043-299-2408

National does not assume any responsibility for use of any circuitry described, no circuit patent licenses are implied and National reserves the right at any time without notice to change said circuitry and specifications.