



Optoelectronics Division
TRW Electronic Components Group

Product Bulletin 6091
January 1985

NPN Silicon Photodarlington

Types OP300, OP301, OP302, OP303, OP304, OP305

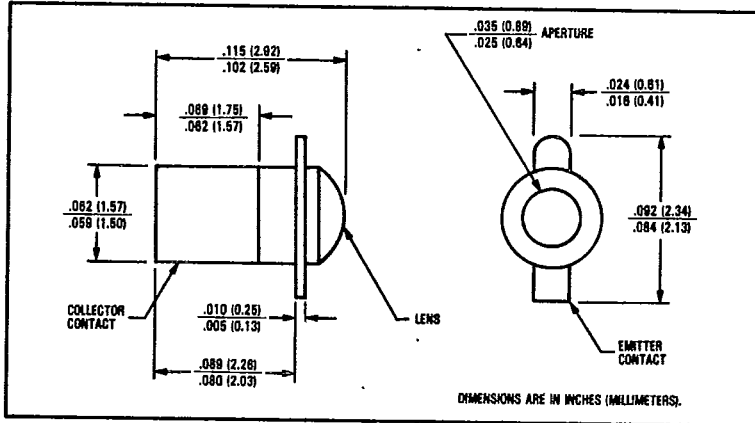
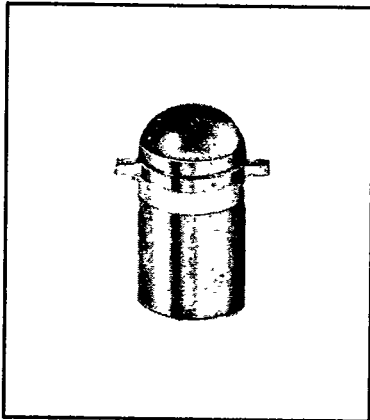

Features

- Miniature hermetically sealed package
- High current gain
- Ideal for direct mounting in PC boards⁽¹⁾

Description

The OP300 through OP305 each consist of an NPN silicon photodarlington mounted in a miniature glass lensed, hermetically sealed, "Pill" package. The lensing effect of the package allows an acceptance half angle of 18° measured from the optical axis to the half power point. Photodarlington are normally used in applications where light signal levels are low and more current gain is needed than is possible with phototransistors. This series is mechanically and spectrally matched to the OP123/124 and OP223/224 series of infrared emitting diodes.

Absolute Maximum Ratings (T_A = 25°C unless otherwise noted)

Collector-Emitter Voltage	15.0 V
Emitter-Collector Voltage	5.0 V
Storage Temperature Range	-65°C to +150°C
Operating Temperature Range	-65°C to +85°C
Soldering Temperature (1/16 inch [1.6 mm] from case for 5 sec. with soldering iron) ⁽²⁾	240°C
Power Dissipation50 mW ⁽³⁾

Notes:

- (1) Refer to Application Bulletin 111 which discusses proper techniques for soldering P11 type devices into PC boards.
- (2) RMA flux is recommended. Duration can be extended to 10 sec. max. when wave soldering.
- (3) Derate linearly 1.0 mW/°C above 25°C.
- (4) Junction temperature maintained at 25°C.
- (5) Light source is an unfiltered tungsten bulb operating at CT = 2870°K or equivalent infrared source.

Typical Performance Curves

Spectral Response of OP300-OP305 vs. GaAlAs and GaAs

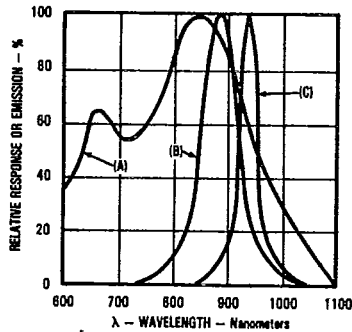

Test Conditions (LED): T_A = T_J = 25°C, I_c = 100 mA, DC = 0.1%, PW = 100 μs
Peak Wavelength - λ_p: (A) XSTR - 850 ± 30 nm, (B) LED GaAlAs - 875 ± 20 nm, (C) LED GaAs - 930 ± 15 nm

Coupling Characteristics of OP123 and OP300

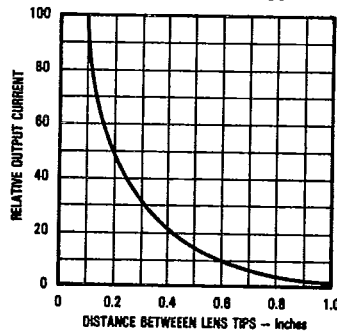

Types OP300, OP301, OP302, OP303, OP304, OP305

T-41-63

Electrical Characteristics (T_A = -40°C to +70°C unless otherwise noted)

Symbol	Parameter	Min.	Typ.	Max.	Units	Test Conditions	
I _{C(ON)} ⁽⁴⁾	On-State Collector Current	OP300	0.80			mA	V _{CE} = 5.0 V, E _B = 1.00 mW/cm ²⁽⁵⁾
		OP301	0.80	2.4		mA	V _{CE} = 5.0 V, E _B = 1.00 mW/cm ²⁽⁵⁾
		OP302	1.80	5.4		mA	V _{CE} = 5.0 V, E _B = 1.00 mW/cm ²⁽⁵⁾
		OP303	3.6	12.0		mA	V _{CE} = 5.0 V, E _B = 1.00 mW/cm ²⁽⁵⁾
		OP304	7.0	21.0		mA	V _{CE} = 5.0 V, E _B = 1.00 mW/cm ²⁽⁵⁾
		OP305	14.0			mA	V _{CE} = 5.0 V, E _B = 1.00 mW/cm ²⁽⁵⁾
I _{CEO}	Collector Dark Current			1.00	μA	V _{CE} = 10.0 V, E _B = 0	
V _{(BR)ICEO}	Collector-Emitter Breakdown Voltage	15.0			V	I _C = 100 μA	
V _{(BR)ECO}	Emitter-Collector Breakdown Voltage	5.0			V	I _E = 100 μA	
V _{CE(SAT)} ⁽⁴⁾	Collector-Emitter Saturation Voltage	OP300, 301		1.10		V	I _C = 0.40 mA, E _B = 1.00 mW/cm ²⁽⁵⁾
		OP302, 304, 305		1.10		V	I _C = 1.00 mA, E _B = 1.00 mW/cm ²⁽⁵⁾



Typical Performance Curves

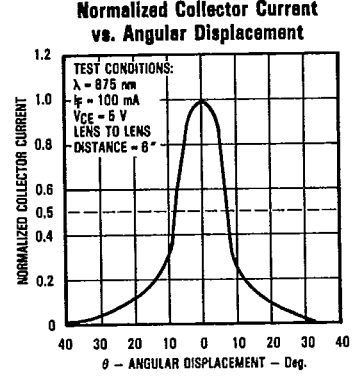
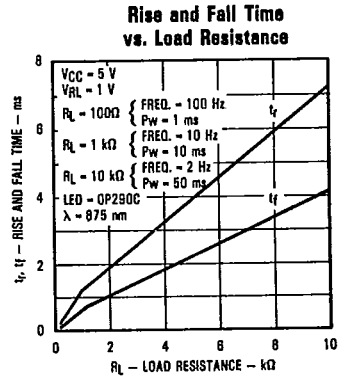
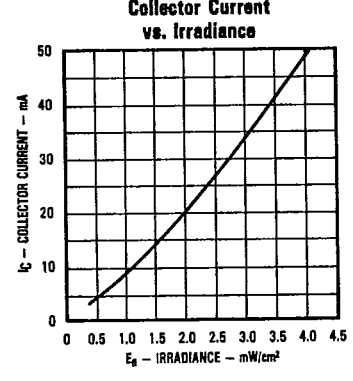
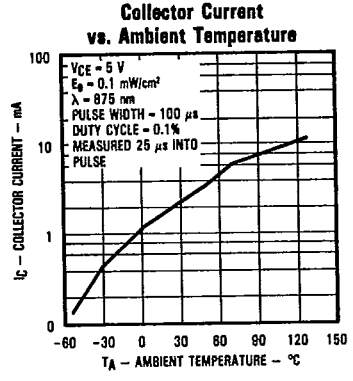
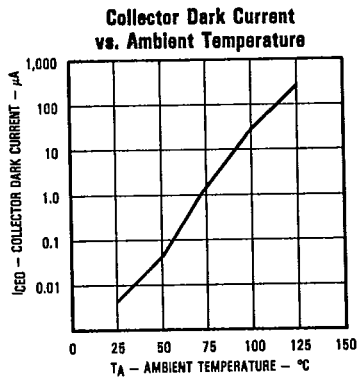

TRW reserves the right to make changes at any time in order to improve design and to supply the best product possible.

Optoelectronics Division, TRW Electronic Components Group, 1215 W. Crosby Rd., Carrollton, TX 75006 (214) 323-2200, TLX 8718032 or 215849 © TRW Inc. 1985, 1982. TRW is the name and mark of TRW Inc. Printed in U.S.A.