

MOTOROLA
SEMICONDUCTOR
 TECHNICAL DATA

Fiber Optics — FLCS Family
Photo Detector
Darlington Output

MFOD73

The MFOD73 is designed for low cost, short distance Fiber Optic Systems using 1000 micron core plastic fiber

Features:

- High Sensitivity Photodarlington Output
- Ideally Matched to MFOE76 Emitter for Plastic Fiber Systems
- Annular Passivated Structure for Stability and Reliability
- FLCS Package
 - Includes Connector
 - Simple Fiber Termination and Connection (Figure 4)
 - Easy Board Mounting
 - Molded Lens for Efficient Coupling
 - Mates with 1000 Micron Core Plastic Fiber (Eska SH4001)

Applications:

- Medical Electronics
- Industrial Controls
- Security Systems
- Short Haul Communication Systems
- High Isolation Interconnects
- M6800 Microprocessor Systems

FLCS FAMILY
FIBER OPTICS
PHOTO DETECTOR
DARLINGTON OUTPUT

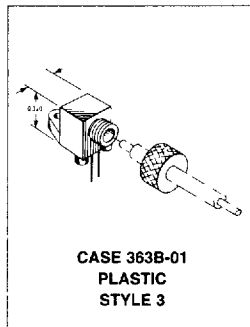

MAXIMUM RATINGS ($T_A = 25^\circ\text{C}$ unless otherwise noted)

Rating	Symbol	Value	Unit
Collector-Emitter Voltage	V_{CEO}	60	Volts
Total Power Dissipation @ $T_A = 25^\circ\text{C}$ Derate above 25°C	P_D	150 2	mW mW/°C
Operating and Storage Junction Temperature Range	T_J, T_{stg}	-40 to +100	°C

ELECTRICAL CHARACTERISTICS ($T_A = 25^\circ\text{C}$ unless otherwise noted)

Characteristic	Symbol	Min	Typ	Max	Unit
Collector Dark Current ($V_{CE} = 10\text{ V}$)	I_D	—	—	100	nA
Collector-Emitter Breakdown Voltage ($I_C = 10\text{ mA}$)	$V_{(BR)CEO}$	60	—	—	Volts

OPTICAL CHARACTERISTICS

Responsivity ($V_{CC} = 5\text{ V}$, Figure 2)	R	1,000	1,500	—	$\mu\text{A}/\mu\text{W}$
Saturation Voltage ($\lambda = 850\text{ nm}$, $V_{CC} = 5\text{ V}$) ($P_{in} = 1\ \mu\text{W}$, $I_C = 2\text{ mA}$)	$V_{CE(sat)}$	—	0.75	1	Volts
Turn-On Time	$R_L = 100\ \Omega$, $P_{in} = 1\ \mu\text{W}$, $\lambda = 850\text{ nm}$, $V_{CC} = 5\text{ V}$	t_{on}	—	125	μs
Turn-Off Time		t_{off}	—	150	μs

TYPICAL COUPLED CHARACTERISTICS

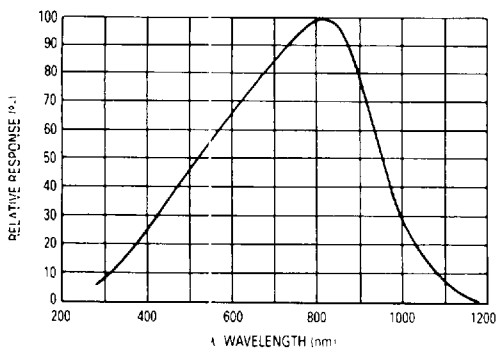

Figure 1. Relative Spectral Response

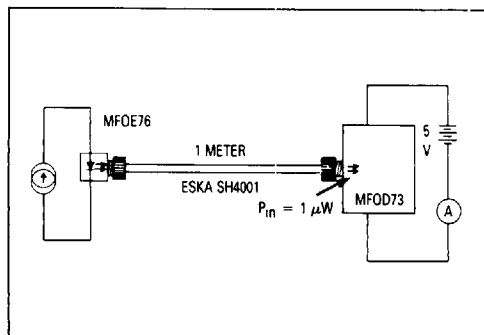

Figure 2. Responsivity Test Configuration

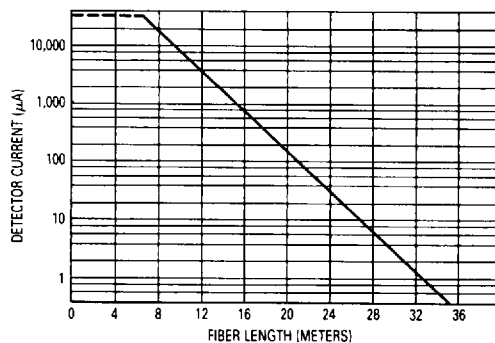

Figure 3. Detector Current versus Fiber Length

The system length achieved with a MFOE76 emitter and various detectors, using 1000 micron core plastic fiber (Eskas SH4001 or equivalent), depends on the LED forward

current (I_f) and the responsivity of the detector chosen. Each detector will perform with the MFOE76 up to the distances shown below

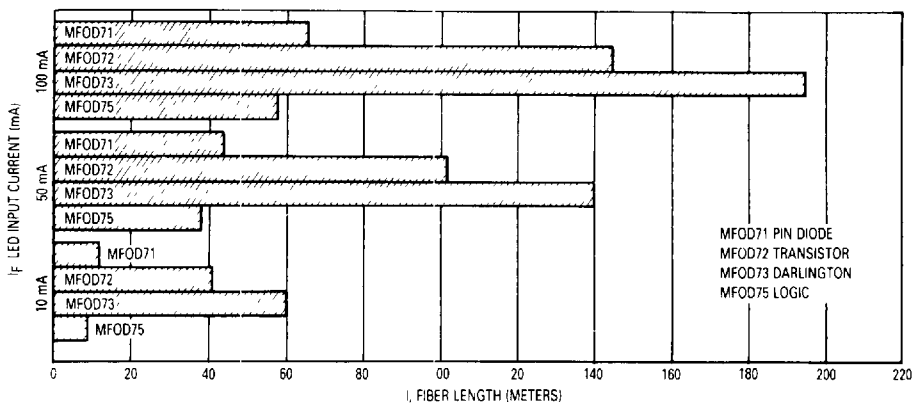

Figure 4. MFOE76 Working Distances

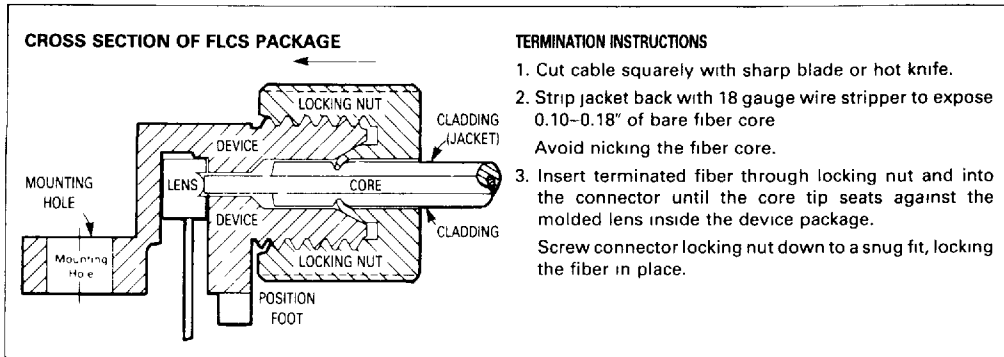

Figure 5. FO Cable Termination and Assembly

INPUT SIGNAL CONDITIONING

The following circuits are suggested to provide the desired forward current through the emitter.

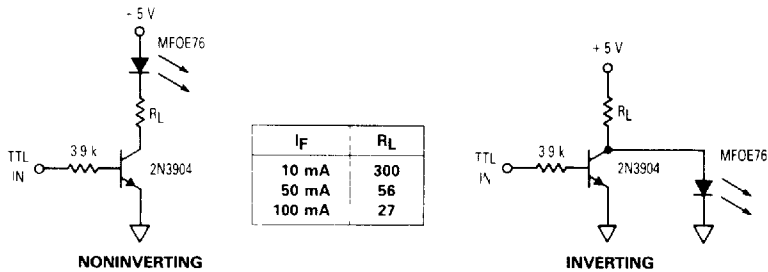

Figure 6. TTL Transmitters

OUTPUT SIGNAL CONDITIONING

The following circuit is suggested to take the FLCS detector output and condition it to drive TTL with an acceptable bit error rate.

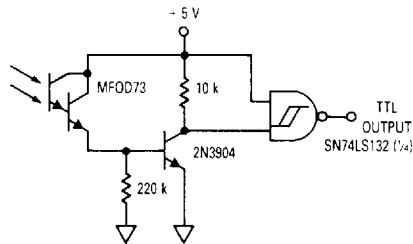

Figure 7. 1 kHz Darlington Receiver