

7724H0664-9 ✓ ACTIVE

Raychem

TE Internal #: 562944-000

High Speed Digital & Data Cable, Cheminax, 77 Ω , 24AWG Wire Size, Operating Temperature Range -65 – 200 °C [-85 – 392 °F]

[View on TE.com >](#)



Wire & Cable > High Speed Digital & Data Cable



High Speed Digital & Data Cable Type: **Cheminax**

Impedance: 77 Ω

Wire Size: **24 AWG**

Operating Temperature Range: -65 – 200 °C [-85 – 392 °F]

Features

Product Type Features

Product Classification	Cable - Coaxial
Cable Style	Twisted Pair
Product Type	Cable
High Speed Digital & Data Cable Type	Cheminax

Electrical Characteristics

	30 pF/ft
Impedance	77 Ω

Body Features

Shield Material	Silver-Coated Copper
Shield Style	Single
Jacket Color	White
Conductor Material	Silver-Plated High Strength Copper

Dimensions

Wire Diameter	.58 mm[.023 in]
Overall Outside Diameter	2.82 mm[.111 in]
Cable Dielectric Diameter	1.19 mm[.047 in]
Wire Size	24 AWG

Usage Conditions

--	--



Operating Temperature Range	-65 – 200 °C[-85 – 392 °F]
-----------------------------	----------------------------

Other

Dielectric Material	Radiation-Crosslinked, Modified ETFE
---------------------	--------------------------------------

Product Compliance

[For compliance documentation, visit the product page on TE.com>](#)

EU RoHS Directive 2011/65/EU	Not Compliant
EU ELV Directive 2000/53/EC	Not Compliant
China RoHS 2 Directive MIIT Order No 32, 2016	Restricted Materials Above Threshold
EU REACH Regulation (EC) No. 1907/2006	Current ECHA Candidate List: JUN 2020 (209) Candidate List Declared Against: JAN 2019 (197) SVHC > Threshold: Cd (.6% in Conductor) Article Safe Usage Statements: Use personal protective equipment as required. Do not eat, drink or smoke when using this product. Recycle if possible and dispose of the article by following all applicable governmental regulations relevant to your geographic location.
Halogen Content	Out of Scope - excluded from Halogen requirements
Solder Process Capability	Not applicable for solder process capability

Product Compliance Disclaimer

This information is provided based on reasonable inquiry of our suppliers and represents our current actual knowledge based on the information they provided. This information is subject to change. The part numbers that TE has identified as EU RoHS compliant have a maximum concentration of 0.1% by weight in homogenous materials for lead, hexavalent chromium, mercury, PBB, PBDE, DBP, BBP, DEHP, DIBP, and 0.01% for cadmium, or qualify for an exemption to these limits as defined in the Annexes of Directive 2011/65/EU (RoHS2). Finished electrical and electronic equipment products will be CE marked as required by Directive 2011/65/EU. Components may not be CE marked. Additionally, the part numbers that TE has identified as EU ELV compliant have a maximum concentration of 0.1% by weight in homogenous materials for lead, hexavalent chromium, and mercury, and 0.01% for cadmium, or qualify for an exemption to these limits as defined in the Annexes of Directive 2000/53/EC (ELV). Regarding the REACH Regulation, the information TE provides on SVHC in articles for this part number is based on the latest European Chemicals Agency (ECHA) 'Guidance on requirements for substances in articles' posted at this URL: <https://echa.europa.eu/guidance-documents/guidance-on-reach>

Compatible Parts

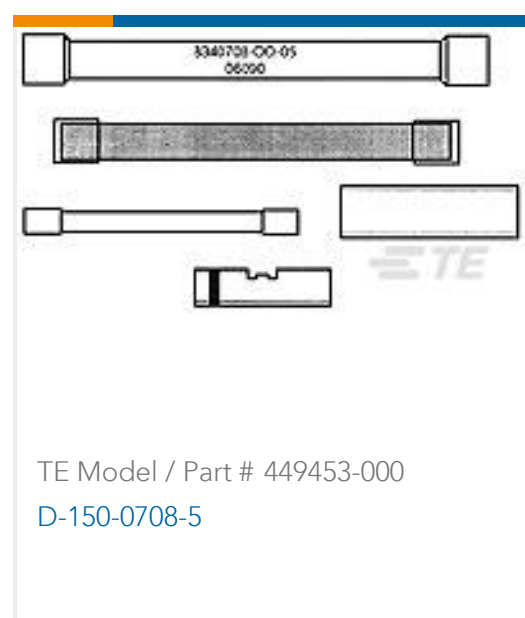

Customers Also Bought

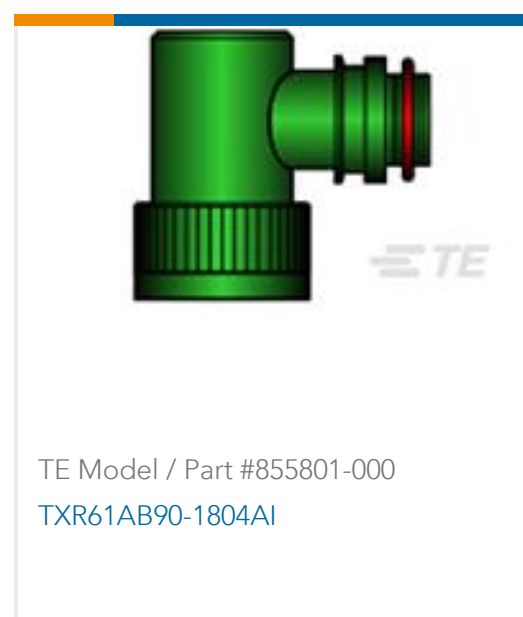
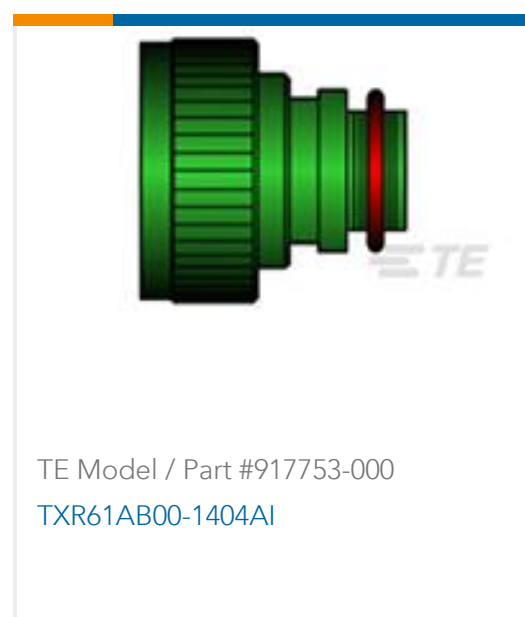
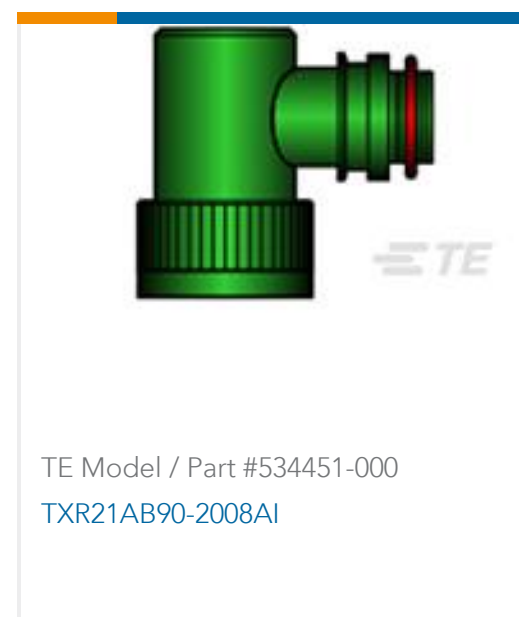
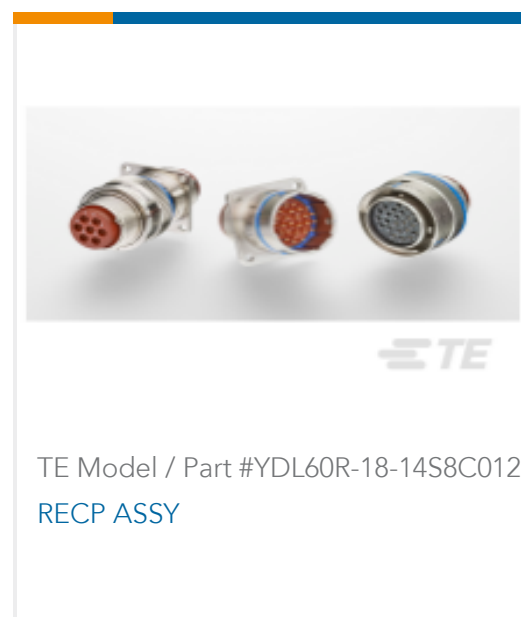
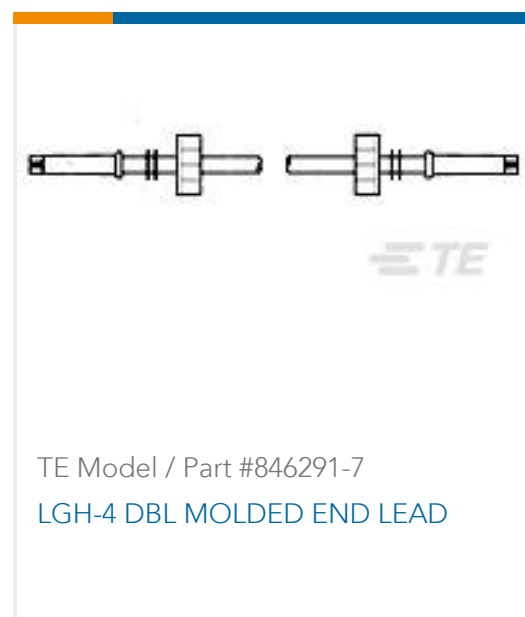
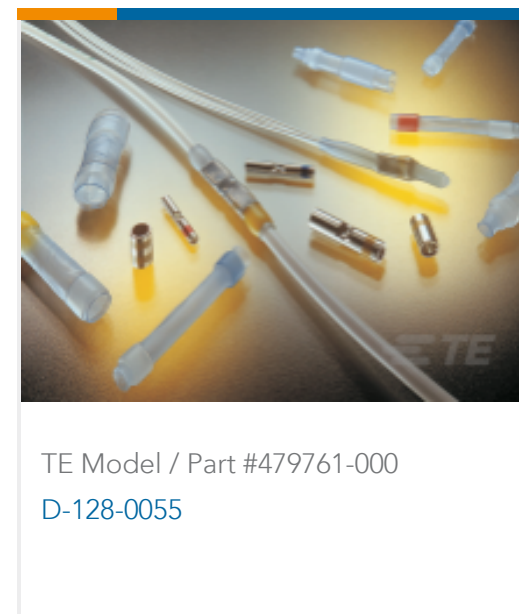
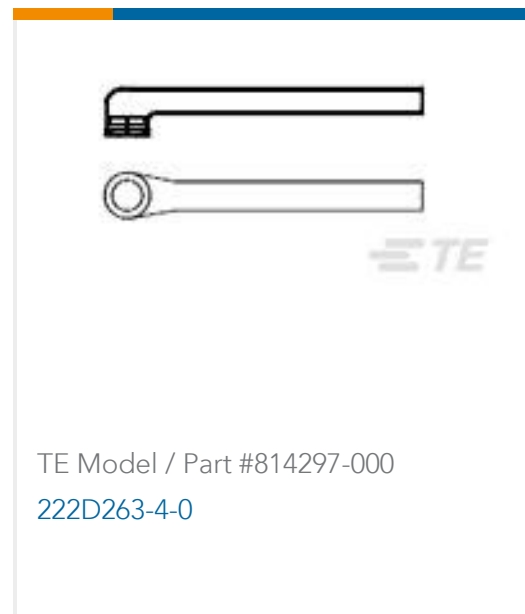

Documents

Product Drawings

7724H0664-9

English

Datasheets & Catalog Pages

1654025_Sec9_CheminaxCables

English

Wire and Cable Overview

English

Product Specifications

Product Specification

English