



**MOTOROLA**

# MC14451

## OSCILLATOR/2<sup>11</sup> to 2<sup>19</sup> DIVIDER/BUFFERED DUTY CYCLE CONTROL

The MC14451 consists of three sections: an oscillator, an 18-stage divider, and a buffered flip-flop for pulse width control and current sink drive. These circuits employ metal-gate complementary MOS devices for low-voltage operation and extremely low power dissipation.

A wide variety of output pulse widths and frequencies can be obtained using the pulse-width-control flip-flop. The number of combinations can be further increased by the variety of crystal frequencies or R-C networks used with the oscillator section.

The buffered output of the duty-cycle-control flip-flop consists of an N-channel MOSFET for maximum current sinking capability and a P-channel active pullup device. Outputs from the 18-stage divider section provide a negative logic binary count.

Applications of the MC14451 include power-off timers, low-power-consumption timers especially suited for battery applications, elapsed timers, wall clocks, auto-timers for feeding systems, fuse timers, incubator timers, weather measurement equipment, and many other battery or low-power applications.

- On-Chip Duty Cycle Control
- Buffered Duty Cycle Control Output
- On-Chip Oscillator
- Low Power Consumption - 20  $\mu$ W typical @ 1.5 Vdc and f = 262 kHz.
- Operating Supply Voltage Range = 1.3 to 3.0 Vdc
- Diode Protection on Inputs

## CMOS MSI

(LOW-POWER COMPLEMENTARY MOS)

## OSCILLATOR/2<sup>11</sup> to 2<sup>19</sup> DIVIDER/BUFFERED DUTY CYCLE CONTROL

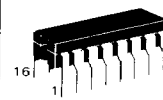

L SUFFIX  
CERAMIC PACKAGE  
CASE 620



P SUFFIX  
PLASTIC PACKAGE  
CASE 648

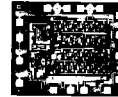

MCC PREFIX  
CHIP

PRODUCT CANCELLED

### BLOCK DIAGRAM

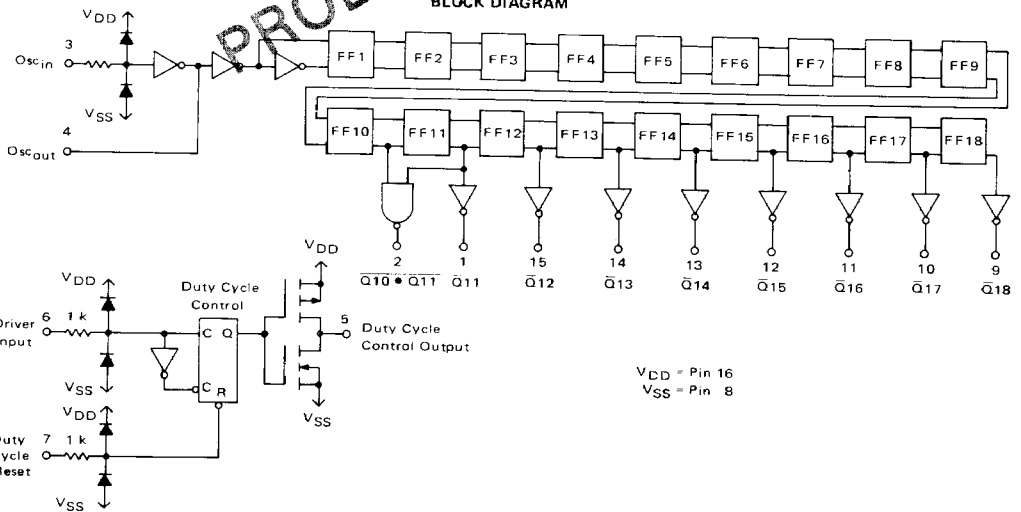

7

**MAXIMUM RATINGS** (Voltages referenced to V<sub>SS</sub>, Pin 8)

Rating	Symbol	Value	Unit
DC Supply Voltages	V <sub>DD</sub>	+3.0 to -0.5	Vdc
Input Voltage, All Inputs	V <sub>in</sub>	V <sub>DD</sub> +0.5 to V <sub>SS</sub> -0.5	Vdc
DC Current Drain per Pin	I	10	mA <sub>dc</sub>
Operating Temperature Range	T <sub>A</sub>	-10 to +60	°C
Storage Temperature Range	T <sub>stg</sub>	-30 to +85	°C

This device contains circuitry to protect the inputs against damage due to high static voltages or electric fields; however, it is advised that normal precautions be taken to avoid application of any voltage higher than maximum rated voltages to this high impedance circuit. For proper operation it is recommended that V<sub>in</sub> and V<sub>out</sub> be constrained to the range V<sub>SS</sub> ≤ (V<sub>in</sub> or V<sub>out</sub>) ≤ V<sub>DD</sub>.

Unused inputs must always be tied to an appropriate logic voltage level (e.g., either V<sub>SS</sub> or V<sub>DD</sub>).

**ELECTRICAL CHARACTERISTICS** (V<sub>DD</sub> = 1.58 Vdc, V<sub>SS</sub> = 0, T<sub>A</sub> = 25°C unless otherwise noted.)

Characteristic	Symbol	Min	Typ	Max	Unit	
Power Supply Operating Range	V <sub>DD</sub>	1.3	1.5	3.0	Vdc	
Output Voltage	V <sub>OH</sub>	1.38	1.5	—	Vdc	
	V <sub>OL</sub>	—	0.0	0.2	Vdc	
Output Drive Current (V <sub>OH</sub> = 1.3 Vdc)	I <sub>OH</sub>	Divider Outputs	-8.0	-25	—	μA <sub>dc</sub>
		Duty Cycle Control Output	-8.0	-25	—	
Output Drive Current (V <sub>OL</sub> = 0.2 Vdc)	I <sub>OL</sub>	Divider Outputs	15	50	—	μA <sub>dc</sub>
		Duty Cycle Control Output	400	1200	—	
Input Current	I <sub>in</sub>	—	0.00001	—	μA <sub>dc</sub>	
Quiescent Device Current	I <sub>Q</sub>	—	1.0	15	μA <sub>dc</sub>	
Dynamic Device Current (f = 262.144 kHz, no output load)	I <sub>DD</sub>	—	20	200	μA <sub>dc</sub>	
Minimum Voltage Required for Oscillator Start	V <sub>DDS</sub>	—	1.2	1.5	Vdc	

**TYPICAL OSCILLATOR CIRCUITS**

FIGURE 1 — 262-kHz CIRCUIT

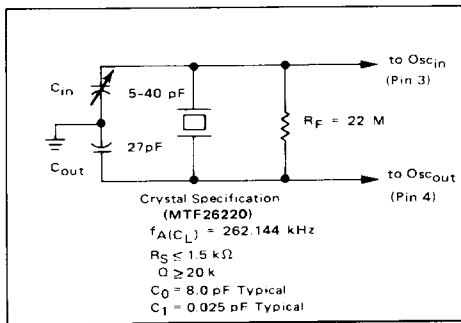

FIGURE 2 — 32.768 kHz CIRCUIT

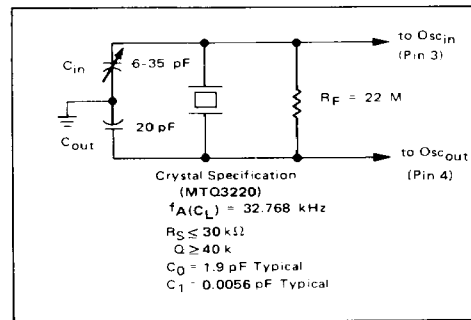
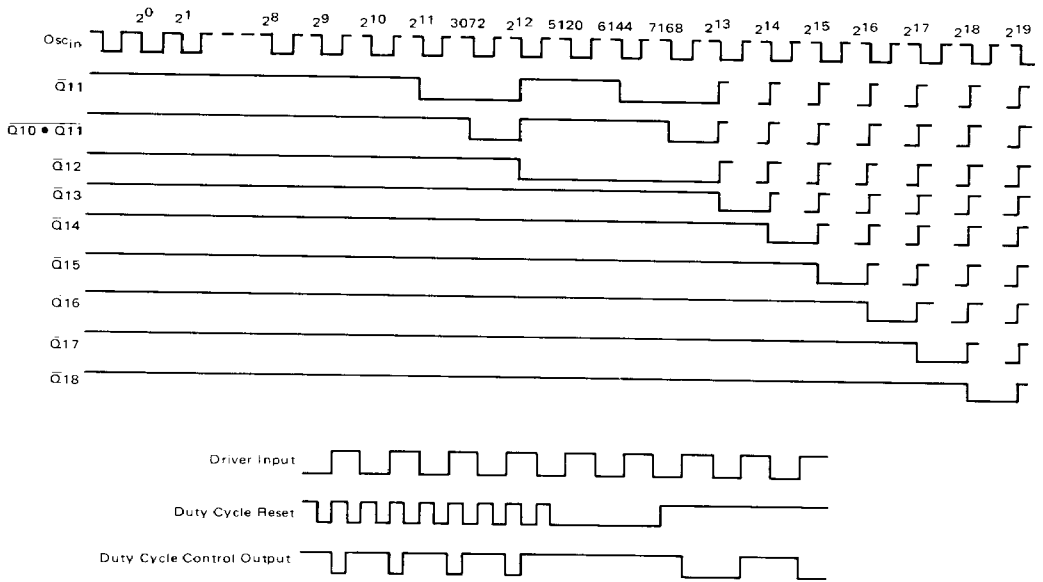
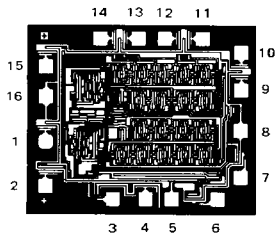

FIGURE 3 – TIMING DIAGRAM



MCC14451 BONDING PADS



Die Size: 67 x 69 mils

Chip geometry subject to change without notice as modifications are made.

Due to die cleavage angles, the actual size of the chip could be up to 7.0 mils (0.17 mm) larger than indicated in both dimensions.

FIGURE 4 – FUNCTIONAL MATRIX

Crystal Frequency = 262.144 kHz

Pin 6 (Driver Input) Connected To:	Characteristic	Pin 7 (Duty Cycle Reset) Connected To:								
		Pin 1 Q11	Pin 2 Q10 • Q11	Pin 15 Q12	Pin 14 Q13	Pin 13 Q14	Pin 12 Q15	Pin 11 Q16	Pin 10 Q17	Pin 9 Q18
Pin 9 Q18	Pulse Width $f_{out}$	3.9 ms 1 Hz	5.85 ms 1 Hz	7.8 ms 1 Hz	15.62 ms 1 Hz	31.25 ms 1 Hz	62.5 ms 1 Hz	125 ms 1 Hz	250 ms 1 Hz	500 ms 1 Hz
Pin 10 Q17	Pulse Width $f_{out}$	3.9 ms 2 Hz	5.85 ms 2 Hz	7.8 ms 2 Hz	15.62 ms 2 Hz	31.25 ms 2 Hz	62.5 ms 2 Hz	125 ms 2 Hz	250 ms 2 Hz	
Pin 11 Q16	Pulse Width $f_{out}$	3.9 ms 4 Hz	5.85 ms 4 Hz	7.8 ms 4 Hz	15.62 ms 4 Hz	31.25 ms 4 Hz	62.5 ms 4 Hz	125 ms 4 Hz		
Pin 12 Q15	Pulse Width $f_{out}$	3.9 ms 8 Hz	5.85 ms 8 Hz	7.8 ms 8 Hz	15.62 ms 8 Hz	31.25 ms 8 Hz	62.5 ms 8 Hz			
Pin 13 Q14	Pulse Width $f_{out}$	3.9 ms 16 Hz	5.85 ms 16 Hz	7.8 ms 16 Hz	15.62 ms 16 Hz	31.25 ms 16 Hz				
Pin 14 Q13	Pulse Width $f_{out}$	3.9 ms 32 Hz	5.85 ms 32 Hz	7.8 ms 32 Hz	15.62 ms 32 Hz					
Pin 15 Q12	Pulse Width $f_{out}$	3.9 ms 64 Hz	5.85 ms 64 Hz	7.8 ms 64 Hz						
Pin 1 Q11	Pulse Width $f_{out}$	3.9 ms 128 Hz								

Crystal Frequency = 32.768 kHz

Pin 6 (Driver Input) Connected To:	Characteristic	Pin 7 (Duty Cycle Reset) Connected To:								
		Pin 1 Q11	Pin 2 Q10 • Q11	Pin 15 Q12	Pin 14 Q13	Pin 13 Q14	Pin 12 Q15	Pin 11 Q16	Pin 10 Q17	Pin 9 Q18
Pin 9 Q18	Pulse Width $f_{out}$	31.3 ms 0.125 Hz	46.8 ms 0.125 Hz	62.5 ms 0.125 Hz	125 ms 0.125 Hz	250 ms 0.125 Hz	500 ms 0.125 Hz	1000 ms 0.125 Hz	2000 ms 0.125 Hz	4000 ms 0.125 Hz
Pin 10 Q17	Pulse Width $f_{out}$	31.3 ms 0.25 Hz	46.8 ms 0.25 Hz	62.5 ms 0.25 Hz	125 ms 0.25 Hz	250 ms 0.25 Hz	500 ms 0.25 Hz	1000 ms 0.25 Hz	2000 ms 0.25 Hz	
Pin 11 Q16	Pulse Width $f_{out}$	31.3 ms 0.5 Hz	46.8 ms 0.5 Hz	62.5 ms 0.5 Hz	125 ms 0.5 Hz	250 ms 0.5 Hz	500 ms 0.5 Hz	1000 ms 0.5 Hz		
Pin 12 Q15	Pulse Width $f_{out}$	31.3 ms 1 Hz	46.8 ms 1 Hz	62.5 ms 1 Hz	125 ms 1 Hz	250 ms 1 Hz	500 ms 1 Hz			
Pin 13 Q14	Pulse Width $f_{out}$	31.3 ms 2 Hz	46.8 ms 2 Hz	62.5 ms 2 Hz	125 ms 2 Hz	250 ms 2 Hz				
Pin 14 Q13	Pulse Width $f_{out}$	31.3 ms 4 Hz	46.8 ms 4 Hz	62.5 ms 4 Hz	125 ms 4 Hz					
Pin 15 Q12	Pulse Width $f_{out}$	31.3 ms 8 Hz	46.8 ms 8 Hz	62.5 ms 8 Hz						
Pin 1 Q11	Pulse Width $f_{out}$	31.3 ns 16 Hz								