

# 4.8 V NPN Silicon Bipolar Common Emitter Transistor

## Technical Data

### AT-38086

#### Features

- 4.8 Volt Pulsed  
(pulse width = 577  $\mu$ sec,  
duty cycle = 12.5%)/CW  
Operation
- +28 dBm Pulsed  $P_{out}$   
@ 900 MHz, Typ.
- +23.5 dBm CW  $P_{out}$   
@ 836.5 MHz, Typ.
- 60% Pulsed Collector  
Efficiency @ 900 MHz, Typ.
- 11 dB Pulsed Power Gain  
@ 900 MHz, Typ.
- -35 dBc  $IMD_3$  @  $P_{out}$  of  
17 dBm per tone, 900 MHz,  
Typ.

#### Applications

- Driver Amplifier for GSM  
and AMPS/ETACS/ 900 MHz  
NMT Cellular Phones
- 900 MHz ISM and Special  
Mobile Radio

#### 85 mil Plastic Surface Mount Package Outline 86

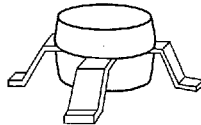

#### Pin Configuration

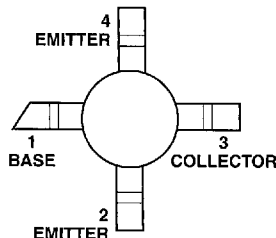

#### Description

Hewlett Packard's AT-38086 is a low cost, NPN silicon bipolar junction transistor housed in a surface mount plastic package. This device is designed for use as a pre-driver or driver device in applications for cellular and wireless communications markets. At 4.8 volts, the AT-38086 features +28 dBm pulsed output power, Class AB operation, and +23.5 dBm CW. Superior efficiency and gain makes the AT-38086 an excellent choice for battery powered systems.

The AT-38086 is fabricated with Hewlett Packard's 10 GHz  $F_t$  Self-Aligned-Transistor (SAT) process. The die are nitride passivated for surface protection. Excellent device uniformity, performance and reliability are produced by the use of ion-implantation, self-alignment techniques, and gold metalization in the fabrication of these devices.

### AT-38086 Absolute Maximum Ratings

Symbol	Parameter	Units	Absolute Maximum <sup>[1]</sup>
V <sub>EBO</sub>	Emitter-Base Voltage	V	1.4
V <sub>CBO</sub>	Collector-Base Voltage	V	16.0
V <sub>CEO</sub>	Collector-Emitter Voltage	V	9.5
I <sub>C</sub>	Collector Current <sup>[2]</sup>	mA	250
I <sub>C</sub>	Collector Current <sup>[3]</sup>	mA	160
P <sub>T</sub>	Peak Power Dissipation <sup>[2, 4]</sup>	W	3.7
P <sub>T</sub>	CW Power Dissipation <sup>[3, 5]</sup>	mW	460
T <sub>j</sub>	Junction Temperature	°C	150
T <sub>STG</sub>	Storage Temperature	°C	-65 to 150

**Thermal Resistance<sup>[6]</sup>:**

$$\theta_{jc} = 140^{\circ}\text{C/W}$$

#### Notes:

1. Permanent damage may occur if any of these limits are exceeded.
2. Pulsed operation, pulse width = 577  $\mu\text{sec}$ , duty cycle = 12.5%.
3. CW operation.
4. Derate at 57.1 mW/°C for T<sub>C</sub> > 85°C. T<sub>C</sub> is defined to be the temperature of the collector pin 3, where the lead contacts the circuit board.
5. Derate at 7.1 mW/°C for T<sub>C</sub> > 85°C. T<sub>C</sub> is defined to be the temperature of the collector pin 3, where the lead contacts the circuit board.
6. Using the liquid crystal technique, V<sub>CE</sub> = 4.5 V, I<sub>C</sub> = 50 mA, T<sub>j</sub> = 150°C, 1-2  $\mu\text{m}$  "hot-spot" resolution.

### Electrical Specifications, T<sub>C</sub> = 25°C

Symbol	Parameters and Test Conditions	Units	Min.	Typ.	Max.
	Freq. = 900 MHz, V <sub>CE</sub> = 4.8 V, I <sub>CQ</sub> = 20 mA, Pulse width = 577 $\mu\text{sec}$ , duty cycle = 12.5%, unless otherwise specified				
P <sub>out</sub>	Output Power, Pulsed Operation <sup>[1]</sup> Test Circuit A, P <sub>in</sub> = +17 dBm	dBm	+26.5	+28.0	
$\eta_C$	Collector Efficiency, Pulsed Operation <sup>[1]</sup> Test Circuit A, P <sub>in</sub> = +17 dBm	%	50	60	
	Mismatch Tolerance No Damage, Pulsed <sup>[1]</sup> Test Circuit A, P <sub>out</sub> = +28 dBm, any phase, 2 sec duration				7:1
P <sub>out</sub>	Output Power, CW Operation <sup>[2]</sup> F = 836.5 MHz, I <sub>CQ</sub> = 15 mA Test Circuit B, P <sub>in</sub> = +10 dBm	dBm	+22.0	+23.5	
IMD <sub>3</sub>	3rd Order Intermodulation Distortion, 2-Tone Test, P <sub>out</sub> each tone = +17 dBm, CW <sup>[2,3]</sup> F1 = 899 MHz, F2 = 901 MHz I <sub>CQ</sub> = 15 mA, Test Circuit B	dBc		-35	
	Mismatch Tolerance, No Damage, CW <sup>[2]</sup> F = 836.5 MHz, I <sub>CQ</sub> = 15 mA Test Circuit B, P <sub>out</sub> = +23.5 dBm any phase, 2 sec duration				7:1
BV <sub>EBO</sub>	Emitter-Base Breakdown Voltage I <sub>E</sub> = 0.2 mA, open collector	V	1.4		
BV <sub>CBO</sub>	Collector-Base Breakdown Voltage I <sub>C</sub> = 1.0 mA, open emitter	V	16.0		
BV <sub>CEO</sub>	Collector-Emitter Breakdown Voltage I <sub>C</sub> = 3.0 mA, open base	V	9.5		
h <sub>FE</sub>	Forward Current Transfer Ratio V <sub>CE</sub> = 3 V, I <sub>C</sub> = 160 mA	—	40	150	330
I <sub>CEO</sub>	Collector Leakage Current V <sub>CEO</sub> = 5 V	$\mu\text{A}$			15

#### Notes:

1. With external matching on input and output, tested in a 50 ohm environment. Refer to Test Circuit A (GSM).
2. With external matching on input and output, tested in a 50 ohm environment. Refer to Test Circuit B (AMPS).
3. Test circuit B re-tuned at 900 MHz.

### AT-38086 Typical Performance, $T_C = 25^\circ\text{C}$

Frequency = 900 MHz,  $V_{CE} = 4.8\text{ V}$ ,  $I_{CQ} = 20\text{ mA}$ , pulsed operation, pulse width = 577  $\mu\text{sec}$ , duty cycle = 12.5%, Test Circuit A (GSM), unless otherwise specified

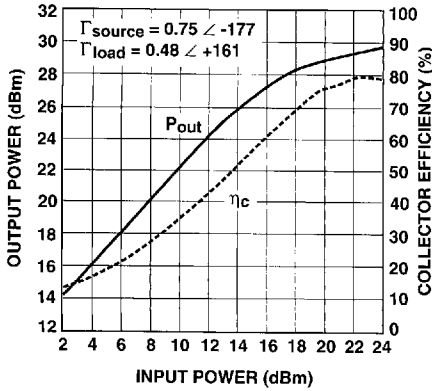

Figure 1. Output Power and Collector Efficiency vs. Input Power.

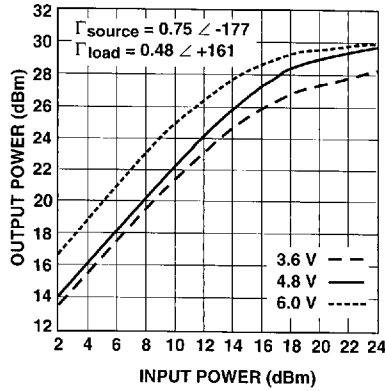

Figure 2. Output Power vs. Input Power Over Bias Voltage.

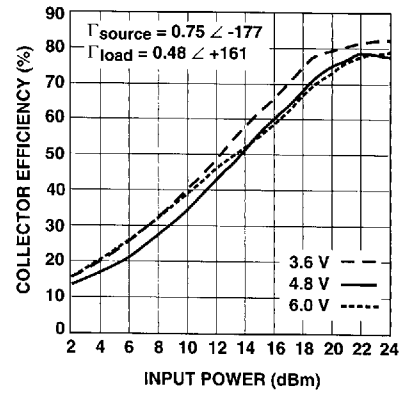

Figure 3. Collector Efficiency vs. Input Power Over Bias Voltage.

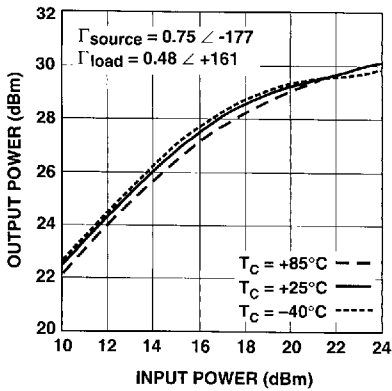

Figure 4. Output Power vs. Input Power Over Temperature.

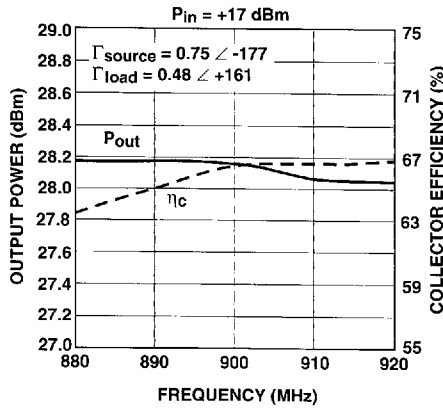

Figure 5. Output Power and Collector Efficiency vs. Frequency.  
Note: Tuned at 900 MHz, then Swept over Frequency.

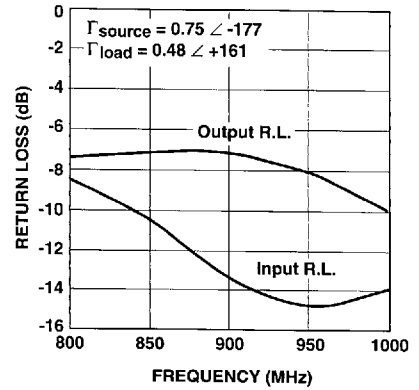

Figure 6. Input and Output Return Loss vs. Frequency.

## AT-38086 Typical Performance, $T_C = 25^\circ\text{C}$

Freq. = 836.5 MHz,  $V_{CE} = 4.8\text{ V}$ ,  $I_{CQ} = 15\text{ mA}$ , CW operation, Test Circuit B (AMPS), unless otherwise specified

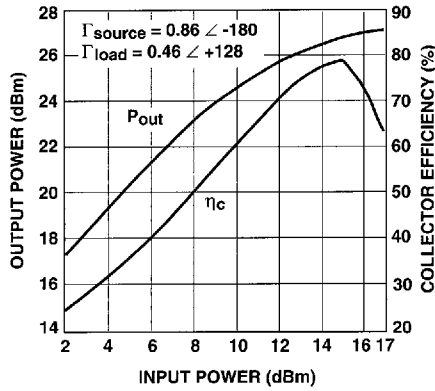

Figure 7. Output Power and Collector Efficiency vs. Input Power.

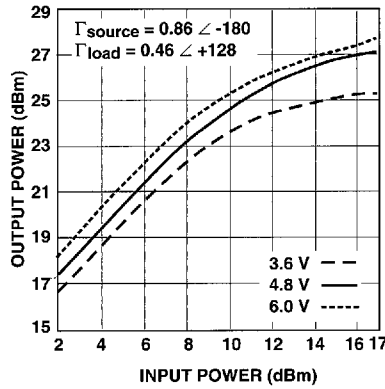

Figure 8. Output Power vs. Input Power Over Bias Voltage.

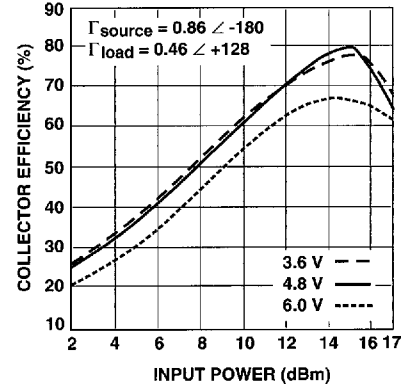

Figure 9. Collector Efficiency vs. Input Power Over Bias Voltage.

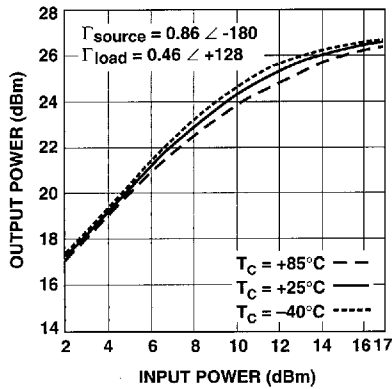

Figure 10. Output Power vs. Input Power Over Temperature.

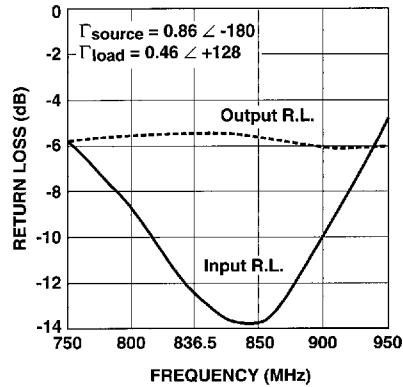

Figure 11. Input and Output Return Loss vs. Frequency.

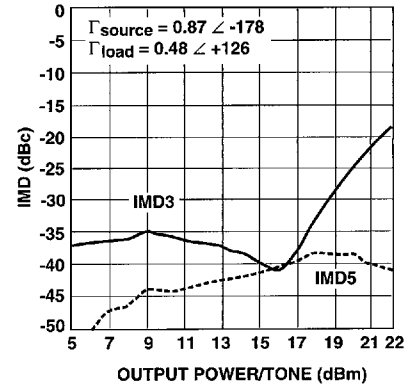

Figure 12. IMD3, IMD5 vs. Output Power Per Tone.

Note: Test circuit B (AMPS) used and re-tuned at 900 MHz.

### AT-38086 Typical Large Signal Impedances (GSM)

Freq. = 900 MHz,  $V_{CE} = 4.8$  V,  $I_{CQ} = 20$  mA, Pulsed Operation,  $P_{out} = +28.0$  dBm

Freq. MHz	$\Gamma_{source}$		$\Gamma_{load}$	
	Mag.	Ang.	Mag.	Ang.
880	0.743	-175.6	0.474	162.0
890	0.741	-176.4	0.476	161.5
900	0.747	-177.3	0.478	161.2
910	0.751	-178.1	0.481	160.0
915	0.752	-178.6	0.482	159.6
920	0.754	-179.1	0.483	158.9

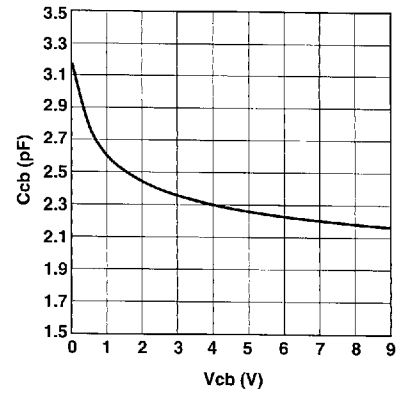

Figure 13. Collector-Base Capacitance vs. Collector-Base Voltage (DC Test).

### AT-38086 Typical Large Signal Impedances (AMPS)

Freq. = 836.5 MHz,  $V_{CE} = 4.8$  V,  $I_{CQ} = 15$  mA, CW Operation,  $P_{out} = +23.5$  dBm

Freq. MHz	$\Gamma_{source}$		$\Gamma_{load}$	
	Mag.	Ang.	Mag.	Ang.
824	0.856	-178.9	0.455	129.1
836.5	0.864	-179.9	0.459	128.2
849	0.870	-179.1	0.464	127.3

### SPICE Model Parameters

#### Die Model

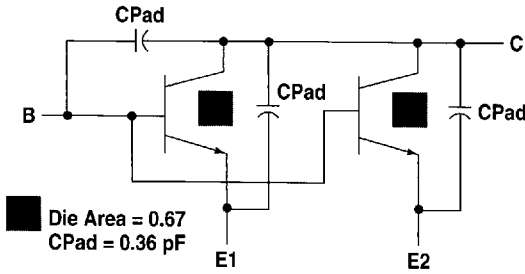

Label	Value	Label	Value
BF	280	NR	0.9886
IKF	299.9	TR	1E-9
ISE	9.9E-11	EG	1.11
NE	2.399	IS	3.598E-15
VAF	33.16	XTI	3
NF	0.9935	CJC	1.02 pF

#### Packaged Model

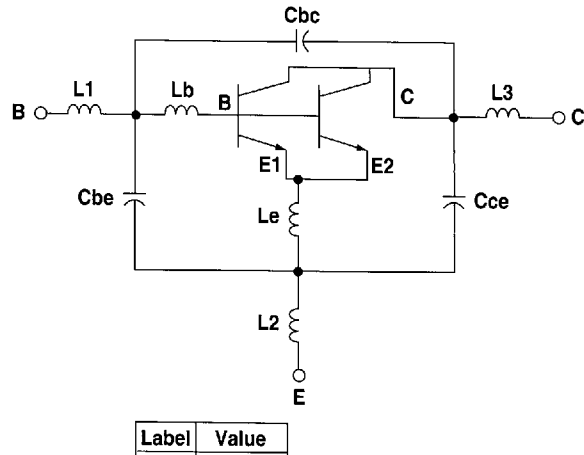

**AT-38086 Typical Scattering Parameters, Common Emitter,  $Z_0 = 50 \Omega$** 
 $V_{CE} = 3.6 \text{ V}, I_c = 50 \text{ mA}, T_c = 25^\circ\text{C}$ 

Freq. GHz	$S_{11}$		$S_{21}$			$S_{12}$			$S_{22}$	
	Mag.	Ang.	dB	Mag.	Ang.	dB	Mag.	Ang.	Mag.	Ang.
0.05	0.71	-85	31.7	38.52	138	-31.7	0.026	54	0.75	-57
0.10	0.73	-124	28.2	25.72	118	-29.1	0.035	39	0.56	-90
0.25	0.75	-160	21.3	11.66	84	-27.3	0.043	35	0.39	-133
0.50	0.76	-176	15.5	5.95	76	-25.5	0.053	43	0.36	-155
0.75	0.76	175	12.0	3.98	72	-23.6	0.066	50	0.36	-165
0.90	0.77	171	10.4	3.32	69	-22.6	0.074	52	0.36	-168
1.00	0.77	169	9.5	2.99	63	-22.0	0.079	54	0.37	-170
1.25	0.78	164	7.6	2.39	57	-20.5	0.094	56	0.38	-174
1.50	0.78	160	6.0	1.99	51	-19.3	0.108	57	0.40	-176
1.75	0.79	156	4.7	1.71	46	-18.3	0.122	57	0.41	-179
2.00	0.80	152	3.5	1.49	41	-17.3	0.137	57	0.43	179
2.25	0.80	148	2.5	1.33	37	-16.4	0.151	57	0.45	176
2.50	0.81	145	1.5	1.19	32	-15.7	0.164	56	0.47	174
2.75	0.81	142	0.7	1.08	28	-15.0	0.178	55	0.49	172
3.00	0.82	139	-0.1	0.99	25	-14.4	0.191	54	0.51	169

 $V_{CE} = 4.8 \text{ V}, I_c = 50 \text{ mA}, T_c = 25^\circ\text{C}$ 

0.05	0.72	-82	31.8	39.02	139	-31.7	0.026	54	0.76	-55
0.10	0.73	-121	28.4	26.32	119	-29.1	0.035	40	0.56	-87
0.25	0.75	-158	21.6	12.00	97	-27.3	0.043	35	0.38	-130
0.50	0.75	-176	15.8	6.14	85	-25.5	0.053	43	0.35	-154
0.75	0.76	176	12.3	4.10	76	-23.7	0.065	49	0.35	-163
0.90	0.76	172	10.7	3.42	72	-22.7	0.073	52	0.35	-167
1.00	0.76	169	9.8	3.08	69	-22.0	0.079	53	0.36	-169
1.25	0.77	164	7.8	2.46	63	-20.6	0.093	56	0.37	-172
1.50	0.78	160	6.2	2.05	57	-19.4	0.107	57	0.38	-175
1.75	0.78	156	4.9	1.76	51	-18.3	0.121	58	0.40	-178
2.00	0.79	152	3.8	1.54	46	-17.4	0.135	57	0.42	180
2.25	0.80	149	2.7	1.37	41	-16.5	0.150	57	0.44	177
2.50	0.80	145	1.8	1.23	37	-15.8	0.163	56	0.46	175
2.75	0.81	142	1.0	1.12	32	-15.0	0.177	55	0.48	173
3.00	0.82	139	0.2	1.02	28	-14.4	0.190	55	0.50	170

 $V_{CE} = 6.0 \text{ V}, I_c = 50 \text{ mA}, T_c = 25^\circ\text{C}$ 

0.05	0.73	-79	31.8	39.07	140	-32.0	0.025	55	0.76	-54
0.10	0.74	-119	28.5	26.60	120	-29.1	0.035	40	0.56	-85
0.25	0.74	-157	21.7	12.21	98	-27.3	0.043	35	0.38	-128
0.50	0.75	-175	15.9	6.25	85	-25.5	0.053	42	0.34	-152
0.75	0.75	176	12.4	4.18	76	-23.7	0.065	49	0.34	-162
0.90	0.76	172	10.8	3.48	72	-22.7	0.073	52	0.34	-166
1.00	0.76	170	9.9	3.13	69	-22.2	0.078	53	0.34	-167
1.25	0.77	165	8.0	2.51	63	-20.7	0.092	56	0.36	-171
1.50	0.77	160	6.4	2.09	57	-19.5	0.106	57	0.37	-174
1.75	0.78	156	5.1	1.79	51	-18.4	0.120	57	0.39	-177
2.00	0.79	152	3.9	1.56	46	-17.5	0.134	58	0.41	-179
2.25	0.79	149	2.9	1.39	41	-16.6	0.148	57	0.43	178
2.50	0.80	146	1.9	1.25	37	-15.8	0.162	56	0.45	176
2.75	0.81	142	1.1	1.13	32	-15.1	0.175	56	0.47	174
3.00	0.81	139	0.3	1.03	28	-14.5	0.188	55	0.49	171

### Typical Performance

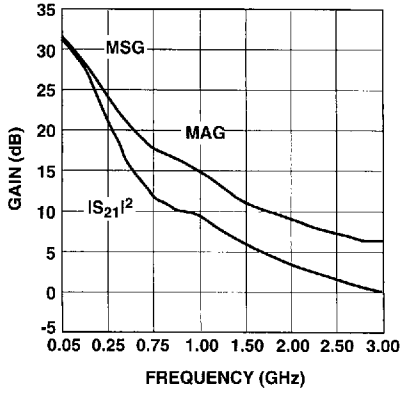

Figure 14. Insertion Power Gain, Maximum Available Gain, and Maximum Stable Gain vs. Frequency.  $V_{CE} = 3.6\text{ V}$ ,  $I_C = 50\text{ mA}$ .

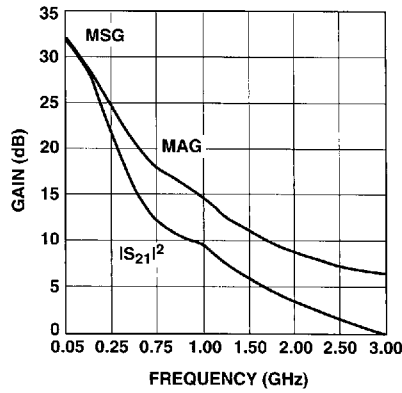

Figure 15. Insertion Power Gain, Maximum Available Gain, and Maximum Stable Gain vs. Frequency.  $V_{CE} = 4.8\text{ V}$ ,  $I_C = 50\text{ mA}$ .

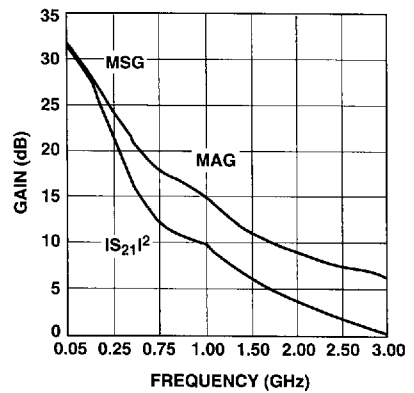

Figure 16. Insertion Power Gain, Maximum Available Gain, and Maximum Stable Gain vs. Frequency.  $V_{CE} = 6.0\text{ V}$ ,  $I_C = 50\text{ mA}$ .

### Part Number Ordering Information

Part Number	No. of Devices	Container
AT-38086-TR1	1000	7" Reel
AT-38086-BLK	100	Antistatic Bag

### Package Dimensions

#### Outline 86

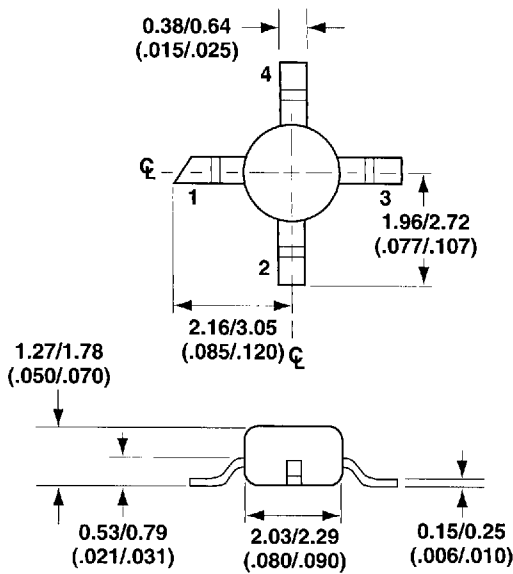

DIMENSIONS ARE IN MILLIMETERS (INCHES)

**Test Circuit A: Test Circuit Board Layout @ 900 MHz for Pulsed Operation (GSM)**

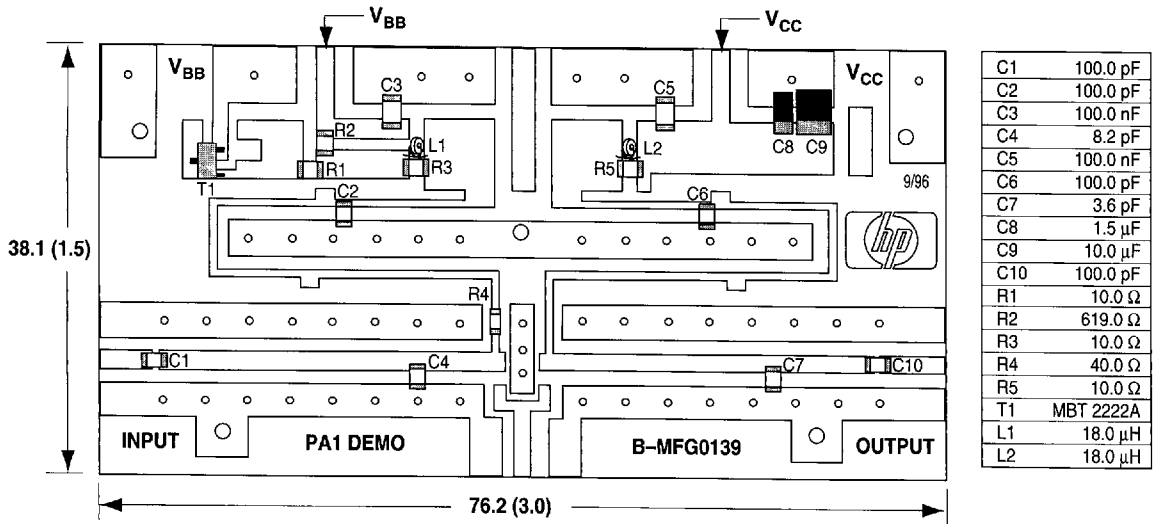

**Pulse Test**  
 $V_{CE} = 4.8\text{ V}$   
 $I_{CQ} = 20\text{ mA}$   
 Freq. = 900 MHz

**Test Circuit:**  
 FR-4 Microstrip, glass epoxy board  
 Dielectric Constant = 4.5  
 Thickness = 0.79 (.031)

**NOTE:**  
 Dimensions are shown in millimeters (inches).

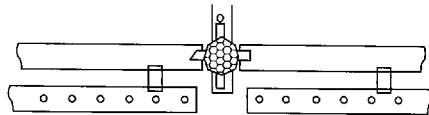

**Test Circuit A: Test Circuit Schematic Diagram @ 900 MHz for Pulsed Operation (GSM)**

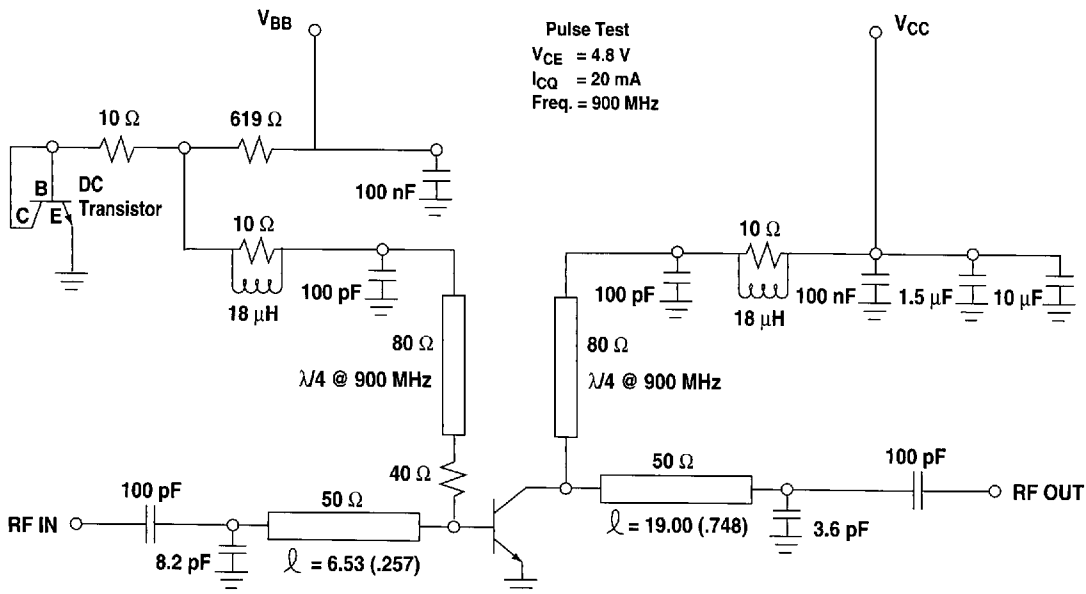

**Test Circuit B: Test Circuit Board Layout @ 836.5 MHz for CW Operation (AMPS)**

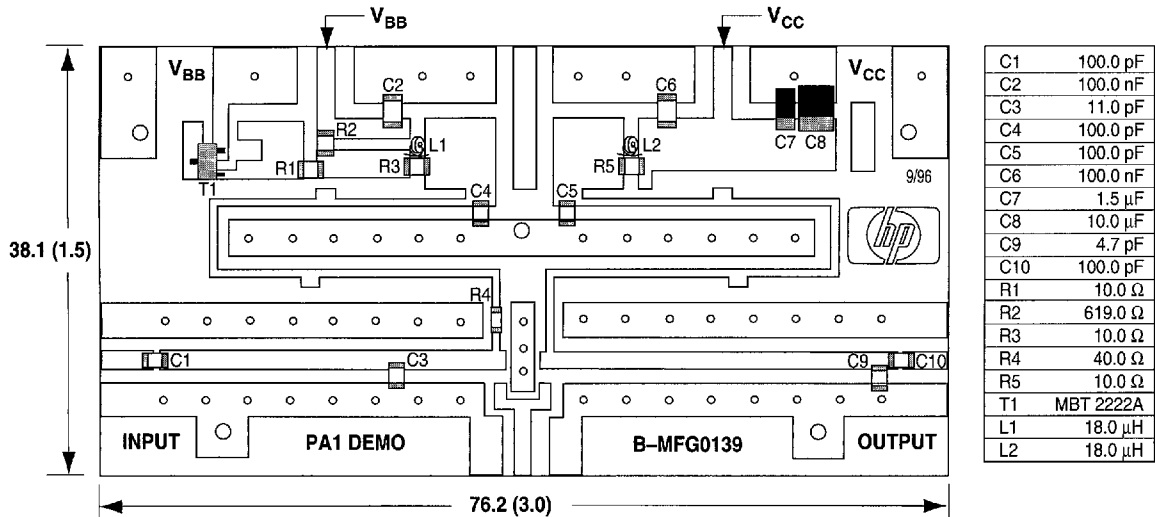

**CW Test**  
 $V_{CE} = 4.8$  V  
 $I_{CQ} = 15$  mA  
 Freq. = 836.5 MHz

**Test Circuit:**  
 FR-4 Microstrip, glass epoxy board  
 Dielectric Constant = 4.5  
 Thickness = 0.79 (.031)

**NOTE:**  
 Dimensions are shown in millimeters (inches).

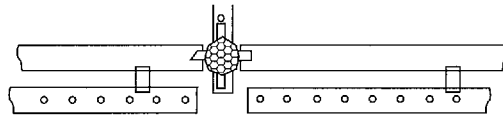

**Test Circuit B: Test Circuit Schematic Diagram @ 836.5 MHz for CW Operation (AMPS)**

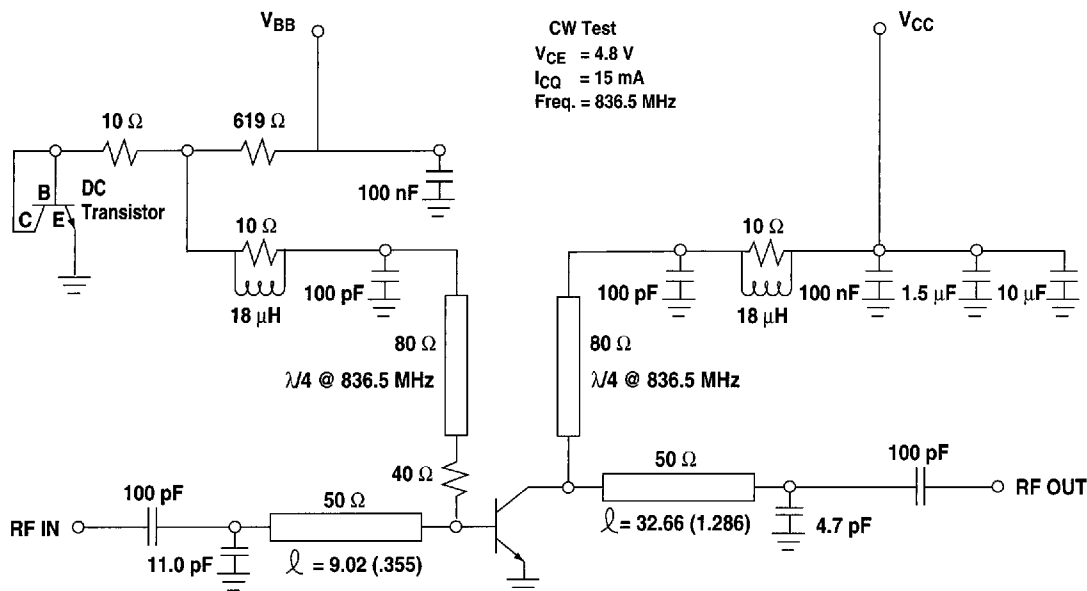

### Tape Dimensions and Product Orientation for Outline 86

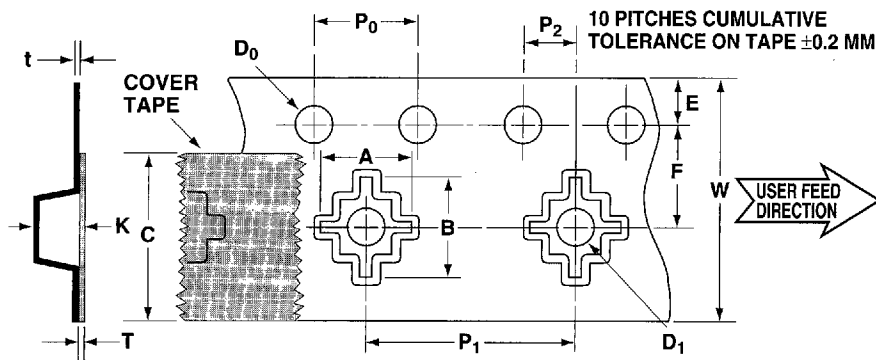
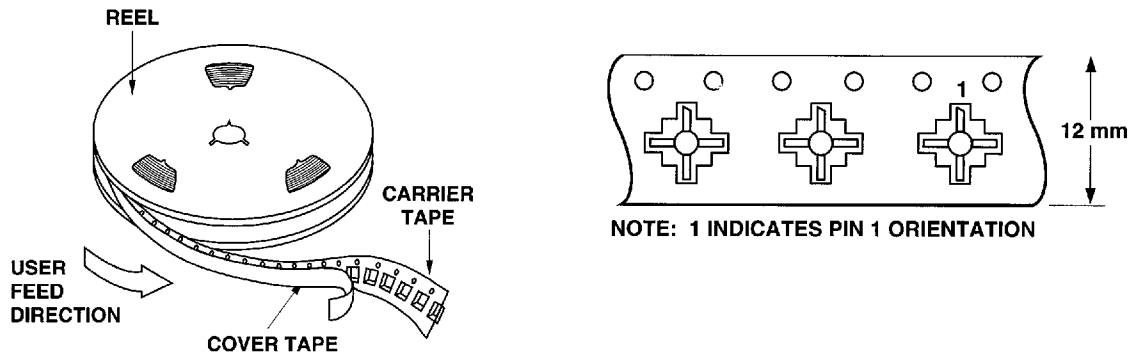

DESCRIPTION		SYMBOL	SIZE (mm)	SIZE (INCHES)
CAVITY	LENGTH	A	$5.77 \pm 0.10$	$0.227 \pm 0.004$
	WIDTH	B	$6.10 \pm 0.10$	$0.240 \pm 0.004$
	DEPTH	K	$1.70 \pm 0.10$	$0.067 \pm 0.004$
	PITCH	$P_1$	$8.00 \pm 0.10$	$0.314 \pm 0.004$
	BOTTOM HOLE DIAMETER	$D_1$	1.50 min.	0.059 min.
PERFORATION	DIAMETER	$D_0$	$1.50 + 0.10/-0.05$	$0.059 + 0.004/-0.002$
	PITCH	$P_0$	$4.00 \pm 0.10$	$0.157 \pm 0.004$
	POSITION	E	$1.75 \pm 0.10$	$0.069 \pm 0.004$
CARRIER TAPE	WIDTH	W	$12.00 \pm 0.20$	$0.472 \pm 0.008$
	THICKNESS	t	$0.30 \pm 0.05$	$0.012 \pm 0.002$
COVER TAPE	WIDTH	C	$9.30 \pm 0.10$	$0.366 \pm 0.004$
	TAPE THICKNESS	T	$0.065 \pm 0.010$	$0.0026 \pm 0.0004$
DISTANCE BETWEEN CENTERLINE	CAVITY TO PERFORATION (WIDTH DIRECTION)	F	$5.50 \pm 0.05$	$0.217 \pm 0.002$
	CAVITY TO PERFORATION (LENGTH DIRECTION)	$P_2$	$2.00 \pm 0.05$	$0.079 \pm 0.002$

For technical assistance or the location of your nearest Hewlett-Packard sales office, distributor or representative call:

**Americas/Canada:** 1-800-235-0312 or 408-654-8675

**Far East/Australasia:** Call your local HP sales office.

**Japan:** (81 3) 3335-8152

**Europe:** Call your local HP sales office.

Data subject to change.  
Copyright © 1997 Hewlett-Packard Co.

Printed in U.S.A. 5965-5959E (3/97)