



### GENERAL DESCRIPTION



The ICS83052I is a low skew, 2:1, Single-ended Multiplexer and a member of the HiPerClockS™ family of High Performance Clock Solutions from ICS. The ICS83052I has two selectable single-ended clock inputs and one single-ended clock output. The output has a  $V_{DDO}$  pin which may be set at 3.3V, 2.5V, or 1.8V, making the device ideal for use in voltage translation applications. An output enable pin places the output in a high impedance state which may be useful for testing or debug. The device operates up to 250MHz and is packaged in an 8 TSSOP.

### FEATURES

- 2:1 single-ended multiplexer
- Q nominal output impedance:  $15\Omega$  ( $V_{DDO} = 3.3V$ )
- Maximum output frequency: 250MHz
- Propagation delay: 2.7ns (maximum), ( $V_{DD} = V_{DDO} = 3.3V$ )
- Input skew: 160ps (maximum), ( $V_{DD} = V_{DDO} = 3.3V$ )
- Part-to-part skew: 490ps (maximum), ( $V_{DD} = V_{DDO} = 3.3V$ )
- Additive phase jitter, RMS at 155.52MHz (12kHz - 20MHz): 0.18ps (typical), ( $V_{DD} = V_{DDO} = 3.3V$ )
- Operating supply modes:
 

$V_{DD}/V_{DDO}$
3.3V/3.3V
3.3V/2.5V
3.3V/1.8V
2.5V/2.5V
2.5V/1.8V
- -40°C to 85°C ambient operating temperature
- Available in both, Standard and RoHS/Lead-Free compliant packages

### BLOCK DIAGRAM

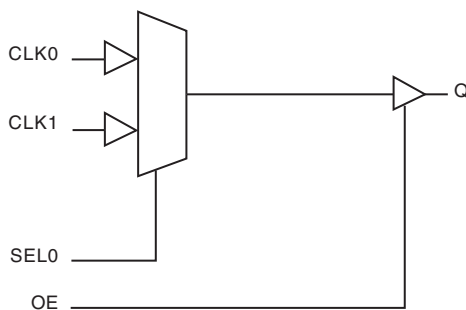

### PIN ASSIGNMENT

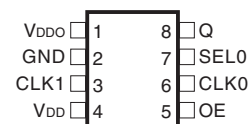

**ICS83052I**  
**8-Lead TSSOP**  
 4.40mm x 3.0mm x 0.925mm  
 package body  
**G Package**  
 Top View



**TABLE 1. PIN DESCRIPTIONS**

Number	Name	Type		Description
1	V <sub>DDO</sub>	Power		Output supply pin.
2	GND	Power		Power supply ground.
3, 6	CLK1, CLK0	Input	Pulldown	Single-ended clock inputs. LVCMOS/LVTTL interface levels.
4	V <sub>DD</sub>	Power		Core supply pin.
5	OE	Input	Pullup	Output enable. When LOW, outputs are in HIGH impedance state. When HIGH, outputs are active. LVCMOS / LVTTL interface levels.
7	SEL0	Input	Pulldown	Clock select input. See Control Input Function Table. LVCMOS / LVTTL interface levels.
8	Q	Output		Single-ended clock output. LVCMOS/LVTTL interface levels.

NOTE: *Pullup* and *Pulldown* refer to internal input resistors. See Table 2, Pin Characteristics, for typical values.

**TABLE 2. PIN CHARACTERISTICS**

Symbol	Parameter	Test Conditions	Minimum	Typical	Maximum	Units
C <sub>IN</sub>	Input Capacitance			4		pF
R <sub>PULLUP</sub>	Input Pullup Resistor			51		kΩ
R <sub>PULLDOWN</sub>	Input Pulldown Resistor			51		kΩ
C <sub>PD</sub>	Power Dissipation Capacitance (per output)	V <sub>DDO</sub> = 3.465V		18		pF
		V <sub>DDO</sub> = 2.625V		19		pF
		V <sub>DDO</sub> = 1.89V		19		pF
R <sub>OUT</sub>	Output Impedance			15		Ω

**TABLE 3. CONTROL INPUT FUNCTION TABLE**

Control Inputs	Input Selected to Q
SEL0	
0	CLK0
1	CLK1



**ABSOLUTE MAXIMUM RATINGS**

Supply Voltage, $V_{DD}$	4.6V
Inputs, $V_I$	-0.5V to $V_{DD} + 0.5 V$
Outputs, $V_O$	-0.5V to $V_{DDO} + 0.5V$
Package Thermal Impedance, $\theta_{JA}$	101.7°C/W (0 mps)
Storage Temperature, $T_{STG}$	-65°C to 150°C

NOTE: Stresses beyond those listed under Absolute Maximum Ratings may cause permanent damage to the device. These ratings are stress specifications only. Functional operation of product at these conditions or any conditions beyond those listed in the *DC Characteristics* or *AC Characteristics* is not implied. Exposure to absolute maximum rating conditions for extended periods may affect product reliability.

**TABLE 4A. POWER SUPPLY DC CHARACTERISTICS,  $V_{DD} = 3.3V \pm 5\%$ ,  $V_{DDO} = 3.3V \pm 5\%$ ,  $2.5V \pm 5\%$  OR  $1.8V \pm 5\%$ ,  $T_A = -40^\circ C$  TO  $85^\circ C$**

Symbol	Parameter	Test Conditions	Minimum	Typical	Maximum	Units
$V_{DD}$	Core Supply Voltage		3.135	3.3	3.465	V
$V_{DDO}$	Output Supply Voltage		3.135	3.3	3.465	V
			2.375	2.5	2.625	V
			1.6	1.8	2.0	V
$I_{DD}$	Power Supply Current			40	mA	
$I_{DDO}$	Output Supply Current			5	mA	

**TABLE 4B. POWER SUPPLY DC CHARACTERISTICS,  $V_{DD} = 2.5V \pm 5\%$ ,  $V_{DDO} = 2.5V \pm 5\%$  OR  $1.8V \pm 5\%$ ,  $T_A = -40^\circ C$  TO  $85^\circ C$**

Symbol	Parameter	Test Conditions	Minimum	Typical	Maximum	Units
$V_{DD}$	Core Supply Voltage		2.375	2.5	2.625	V
$V_{DDO}$	Output Supply Voltage		2.375	2.5	2.625	V
			1.6	1.8	2.0	V
$I_{DD}$	Power Supply Current			36	$\mu A$	
$I_{DDO}$	Output Supply Current			5	$\mu A$	



**TABLE 4C. LVCMOS/LVTTL DC CHARACTERISTICS,  $T_A = -40^{\circ}\text{C}$  TO  $85^{\circ}\text{C}$**

Symbol	Parameter	Test Conditions	Minimum	Typical	Maximum	Units
$V_{IH}$	Input High Voltage	$V_{DD} = 3.3\text{V} \pm 5\%$	2		$V_{DD} + 0.3$	V
		$V_{DD} = 2.5\text{V} \pm 5\%$	1.7		$V_{DD} + 0.3$	V
$V_{IL}$	Input Low Voltage	$V_{DD} = 3.3\text{V} \pm 5\%$	-0.3		0.8	V
		$V_{DD} = 2.5\text{V} \pm 5\%$	-0.3		0.7	V
$I_{IH}$	Input High Current	CLK0, CLK1, SELO $V_{DD} = 3.3\text{V}$ or $2.5\text{V} \pm 5\%$			150	$\mu\text{A}$
		OE $V_{DD} = 3.3\text{V}$ or $2.5\text{V} \pm 5\%$			5	$\mu\text{A}$
$I_{IL}$	Input Low Current	CLK0, CLK1, SELO $V_{DD} = 3.3\text{V}$ or $2.5\text{V} \pm 5\%$	-5			$\mu\text{A}$
		OE $V_{DD} = 3.3\text{V}$ or $2.5\text{V} \pm 5\%$	-150			$\mu\text{A}$
$V_{OH}$	Output High Voltage	$V_{DDO} = 3.3\text{V} \pm 5\%$ ; NOTE 1	2.6			V
		$V_{DDO} = 2.5\text{V} \pm 5\%$ ; NOTE 1	1.8			V
		$V_{DDO} = 1.8\text{V} \pm 5\%$ ; NOTE 1	$V_{DD} - 0.3$			V
$V_{OL}$	Output Low Voltage	$V_{DDO} = 3.3\text{V} \pm 5\%$ ; NOTE 1			0.5	V
		$V_{DDO} = 2.5\text{V} \pm 5\%$ ; NOTE 1			0.45	V
		$V_{DDO} = 1.8\text{V} \pm 5\%$ ; NOTE 1			0.35	V

NOTE 1: Outputs terminated with  $50\Omega$  to  $V_{DDO}/2$ . See Parameter Measurement section, "Load Test Circuit" diagrams.

**TABLE 5A. AC CHARACTERISTICS,  $V_{DD} = V_{DDO} = 3.3\text{V} \pm 5\%$ ,  $T_A = -40^{\circ}\text{C}$  TO  $85^{\circ}\text{C}$**

Symbol	Parameter	Test Conditions	Minimum	Typical	Maximum	Units
$f_{MAX}$	Output Frequency				250	MHz
$tp_{LH}$	Propagation Delay, Low to High; NOTE 1		2.0	2.4	2.7	ns
$tp_{HL}$	Propagation Delay, High to Low; NOTE 1		2.0	2.5	2.9	ns
$tsk(i)$	Input Skew; NOTE 4			36	160	ps
$tsk(pp)$	Part-to-Part Skew; NOTE 2, 4				490	ps
$f_{jit}$	Buffer Additive Phase Jitter, RMS; refer to Additive Phase Jitter section, NOTE 3	155.52MHz, Integration Range: 12kHz - 20MHz		0.18		ps
$t_R / t_F$	Output Rise/Fall Time	20% to 80%	200		700	ps
odc	Output Duty Cycle		45		55	%
$MUX_{ISOLATION}$	MUX Isolation			45		dB

NOTE 1: Measured from  $V_{DD}/2$  of the input to  $V_{DDO}/2$  of the output.

NOTE 2: Defined as skew between outputs on different devices operating at the same supply voltages and with equal load conditions. Using the same type of input on each device, the output is measured at  $V_{DDO}/2$ .

NOTE 3: Driving only one input clock.

NOTE 4: This parameter is defined in accordance with JEDEC Standard 65.



**TABLE 5B. AC CHARACTERISTICS,  $V_{DD} = 3.3V \pm 5\%$ ,  $V_{DDO} = 2.5V \pm 5\%$ ,  $T_A = -40^\circ C$  TO  $85^\circ C$**

Symbol	Parameter	Test Conditions	Minimum	Typical	Maximum	Units
$f_{MAX}$	Output Frequency				250	MHz
$tp_{LH}$	Propagation Delay, Low to High; NOTE 1		2.3	2.6	2.9	ns
$tp_{HL}$	Propagation Delay, High to Low; NOTE 1		2.3	2.6	2.9	ns
$tsk(i)$	Input Skew; NOTE 4			23	106	ps
$tsk(pp)$	Part-to-Part Skew; NOTE 2, 4				350	ps
$f_{jit}$	Buffer Additive Phase Jitter, RMS; refer to Additive Phase Jitter section, NOTE 3	155.52MHz, Integration Range: 12kHz - 20MHz		0.14		ps
$t_R / t_F$	Output Rise/Fall Time	20% to 80%	300		700	ps
odc	Output Duty Cycle		46		54	%
$MUX_{ISOLATION}$	MUX Isolation			45		dB

NOTE 1: Measured from  $V_{DD}/2$  of the input to  $V_{DDO}/2$  of the output.

NOTE 2: Defined as skew between outputs on different devices operating at the same supply voltages and with equal load conditions. Using the same type of input on each device, the output is measured at  $V_{DDO}/2$ .

NOTE 3: Driving only one input clock.

NOTE 4: This parameter is defined in accordance with JEDEC Standard 65.

**TABLE 5C. AC CHARACTERISTICS,  $V_{DD} = 3.3V \pm 5\%$ ,  $V_{DDO} = 1.8V \pm 5\%$ ,  $T_A = -40^\circ C$  TO  $85^\circ C$**

Symbol	Parameter	Test Conditions	Minimum	Typical	Maximum	Units
$f_{MAX}$	Output Frequency				250	MHz
$tp_{LH}$	Propagation Delay, Low to High; NOTE 1		2.3	3.1	3.9	ns
$tp_{HL}$	Propagation Delay, High to Low; NOTE 1		2.3	3.1	3.9	ns
$tsk(i)$	Input Skew; NOTE 4			19	66	ps
$tsk(pp)$	Part-to-Part Skew; NOTE 2, 4				350	ps
$f_{jit}$	Buffer Additive Phase Jitter, RMS; refer to Additive Phase Jitter section, NOTE 3	155.52MHz, Integration Range: 12kHz - 20MHz		0.16		ps
$t_R / t_F$	Output Rise/Fall Time	20% to 80%	350		850	ps
odc	Output Duty Cycle		46		54	%
$MUX_{ISOLATION}$	MUX Isolation			45		dB

NOTE 1: Measured from  $V_{DD}/2$  of the input to  $V_{DDO}/2$  of the output.

NOTE 2: Defined as skew between outputs on different devices operating at the same supply voltages and with equal load conditions. Using the same type of input on each device, the output is measured at  $V_{DDO}/2$ .

NOTE 3: Driving only one input clock.

NOTE 4: This parameter is defined in accordance with JEDEC Standard 65.



**TABLE 5D. AC CHARACTERISTICS,  $V_{DD} = V_{DDO} = 2.5V \pm 5\%$ ,  $T_A = -40^\circ C$  TO  $85^\circ C$**

Symbol	Parameter	Test Conditions	Minimum	Typical	Maximum	Units
$f_{MAX}$	Output Frequency				250	MHz
$tp_{LH}$	Propagation Delay, Low to High; NOTE 1		2.2	2.7	3.2	ns
$tp_{HL}$	Propagation Delay, High to Low; NOTE 1		2.2	2.7	3.2	ns
$tsk(i)$	Input Skew; NOTE 4			28	123	ps
$tsk(pp)$	Part-to-Part Skew; NOTE 2, 4				400	ps
$t_{jit}$	Buffer Additive Phase Jitter, RMS; refer to Additive Phase Jitter section, NOTE 3	155.52MHz, Integration Range: 12kHz - 20MHz		0.22		ps
$t_R / t_F$	Output Rise/Fall Time	20% to 80%	300		700	ps
odc	Output Duty Cycle		45		55	%
$MUX_{ISOLATION}$	MUX Isolation			45		dB

NOTE 1: Measured from VDD/2 of the input to VDDO/2 of the output.

NOTE 2: Defined as skew between outputs on different devices operating at the same supply voltages and with equal load conditions. Using the same type of input on each device, the output is measured at VDDO/2.

NOTE 3: Driving only one input clock.

NOTE 4: This parameter is defined in accordance with JEDEC Standard 65.

**TABLE 5E. AC CHARACTERISTICS,  $V_{DD} = 2.5V \pm 5\%$ ,  $V_{DDO} = 1.8V \pm 5\%$ ,  $T_A = -40^\circ C$  TO  $85^\circ C$**

Symbol	Parameter	Test Conditions	Minimum	Typical	Maximum	Units
$f_{MAX}$	Output Frequency				250	MHz
$tp_{LH}$	Propagation Delay, Low to High; NOTE 1		2.1	3.1	4.1	ns
$tp_{HL}$	Propagation Delay, High to Low; NOTE 1		2.1	3.1	4.2	ns
$tsk(i)$	Input Skew; NOTE 4			19	73	ps
$tsk(pp)$	Part-to-Part Skew; NOTE 2, 4				350	ps
$t_{jit}$	Buffer Additive Phase Jitter, RMS; refer to Additive Phase Jitter section, NOTE 3	155.52MHz, Integration Range: 12kHz - 20MHz		0.19		ps
$t_R / t_F$	Output Rise/Fall Time	20% to 80%	350		850	ps
odc	Output Duty Cycle		45		55	%
$MUX_{ISOLATION}$	MUX Isolation			45		dB

NOTE 1: Measured from VDD/2 of the input to VDDO/2 of the output.

NOTE 2: Defined as skew between outputs on different devices operating at the same supply voltages and with equal load conditions. Using the same type of input on each device, the output is measured at VDDO/2.

NOTE 3: Driving only one input clock.

NOTE 4: This parameter is defined in accordance with JEDEC Standard 65.



### ADDITIVE PHASE JITTER

The spectral purity in a band at a specific offset from the fundamental compared to the power of the fundamental is called the **dBc Phase Noise**. This value is normally expressed using a Phase noise plot and is most often the specified plot in many applications. Phase noise is defined as the ratio of the noise power present in a 1Hz band at a specified offset from the fundamental frequency to the power value of the fundamental. This ratio is expressed in decibels (dBm) or a ratio of the power in

the 1Hz band to the power in the fundamental. When the required offset is specified, the phase noise is called a **dBc** value, which simply means dBm at a specified offset from the fundamental. By investigating jitter in the frequency domain, we get a better understanding of its effects on the desired application over the entire time record of the signal. It is mathematically possible to calculate an expected bit error rate given a phase noise plot.

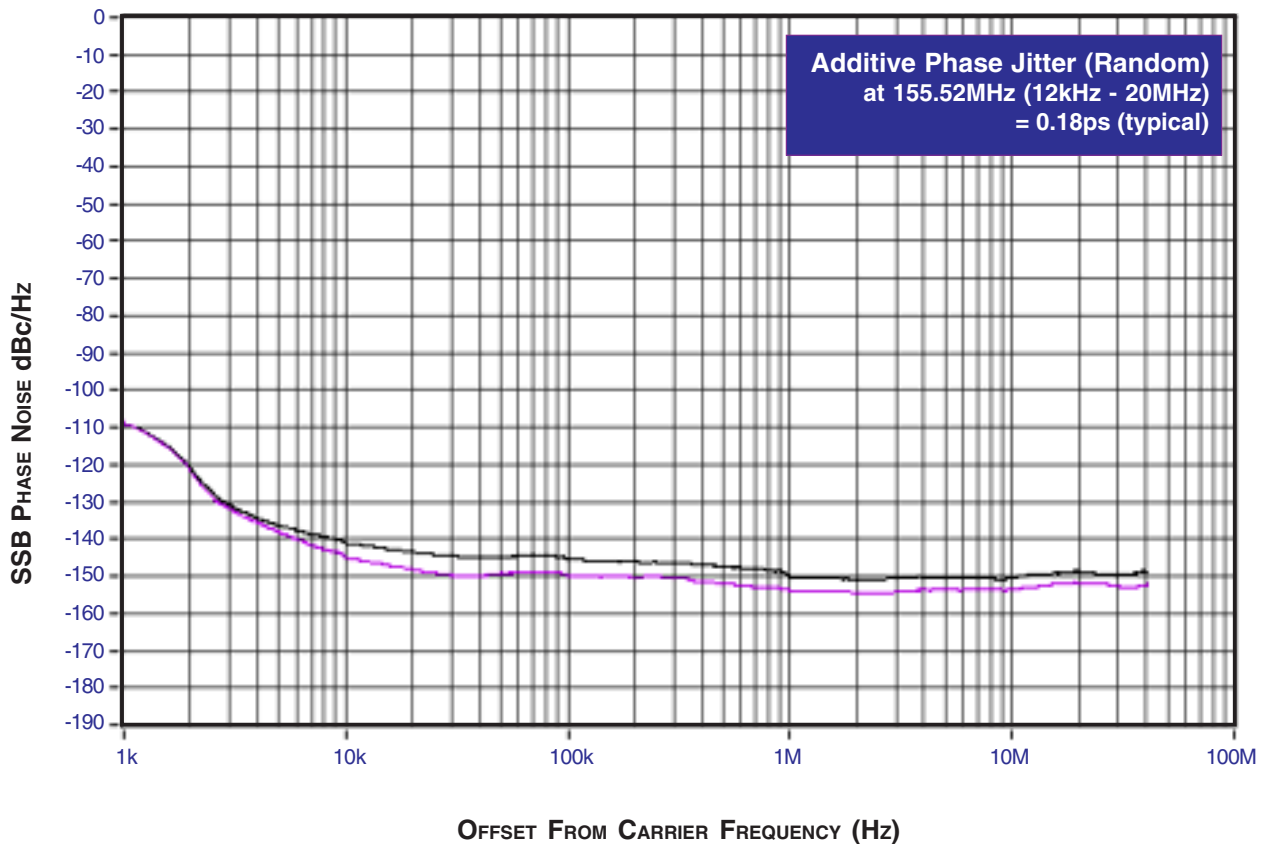

As with most timing specifications, phase noise measurements have issues. The primary issue relates to the limitations of the equipment. Often the noise floor of the equipment is higher than the noise floor of the device. This is illustrated

above. The device meets the noise floor of what is shown, but can actually be lower. The phase noise is dependant on the input source and measurement equipment.



**PARAMETER MEASUREMENT INFORMATION**

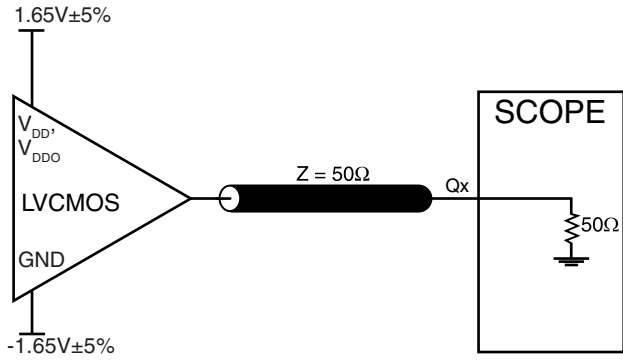

**3.3V CORE/3.3V OUTPUT LOAD AC TEST CIRCUIT**

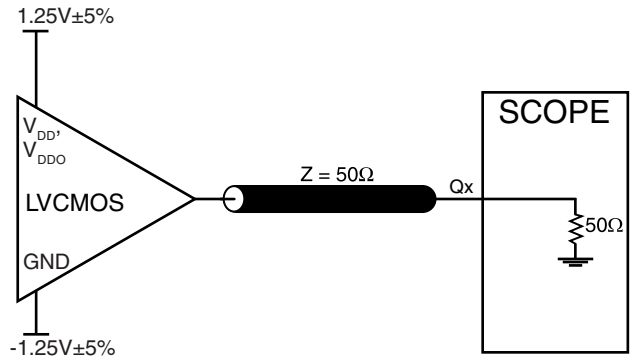

**2.5V CORE/2.5V OUTPUT LOAD AC TEST CIRCUIT**

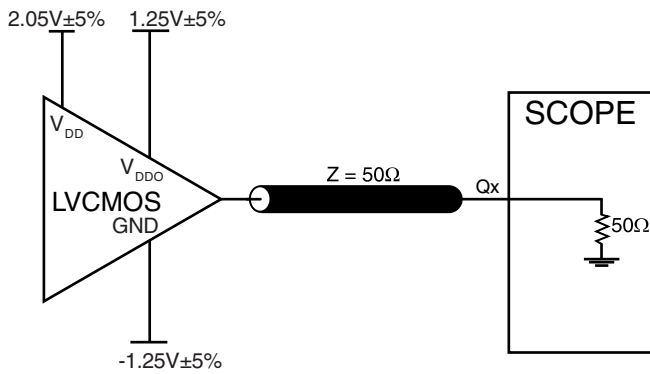

**3.3V CORE/2.5V OUTPUT LOAD AC TEST CIRCUIT**

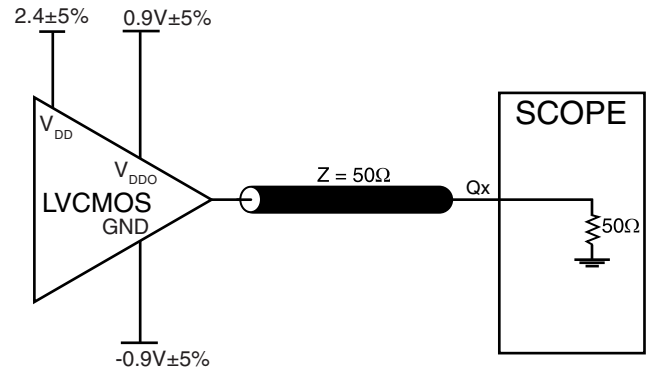

**3.3V CORE/1.8V OUTPUT LOAD AC TEST CIRCUIT**

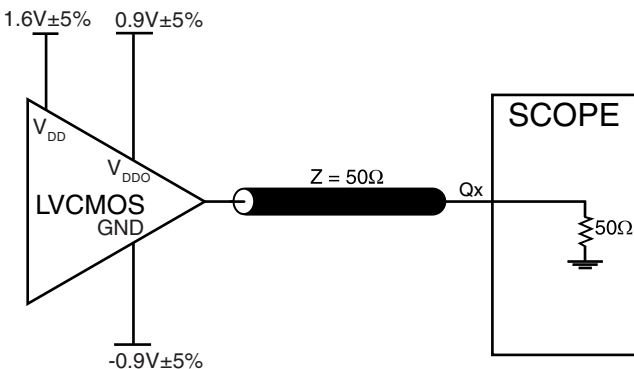

**2.5 CORE/1.8V OUTPUT LOAD AC TEST CIRCUIT**

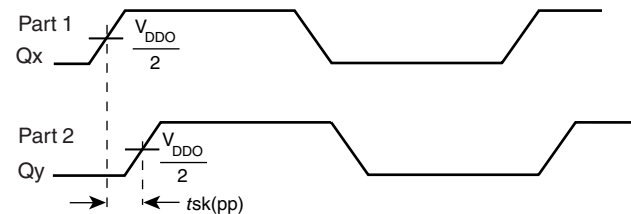

**PART-TO-PART SKEW**

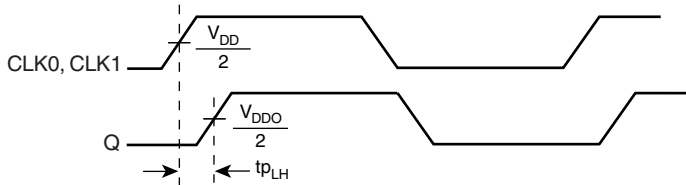

**PROPAGATION DELAY**

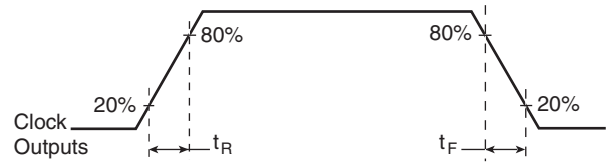

**OUTPUT RISE/FALL TIME**

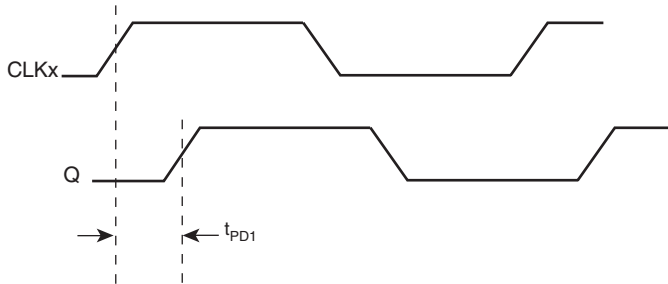

**INPUT SKEW**

$$tsk(i) = |t_{PD1} - t_{PD2}|$$

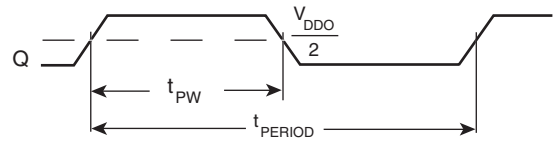

$$odc = \frac{t_{PW}}{t_{PERIOD}} \times 100\%$$

**OUTPUT DUTY CYCLE/PULSE WIDTH/PERIOD**



## APPLICATION INFORMATION

### RECOMMENDATIONS FOR UNUSED INPUT AND OUTPUT PINS

#### INPUTS:

##### CLK INPUT:

For applications not requiring the use of the test clock, it can be left floating. Though not required, but for additional protection, a 1kΩ resistor can be tied from the CLK input to ground.

##### CONTROL PINS:

All control pins have internal pull-ups or pull-downs; additional resistance is not required but can be added for additional protection. A 1kΩ resistor can be used.

#### OUTPUTS:

##### LVC MOS OUTPUT:

All unused LVC MOS output can be left floating. We recommend that there is no trace attached.

## RELIABILITY INFORMATION

TABLE 6.  $\theta_{JA}$  VS. AIR FLOW TABLE FOR 8 LEAD TSSOP

$\theta_{JA}$ by Velocity (Meters per Second)			
	0	1	2.5
Multi-Layer PCB, JEDEC Standard Test Boards	101.7°C/W	90.5°C/W	89.8°C/W

#### TRANSISTOR COUNT

The transistor count for ICS83052I is: 967



PACKAGE OUTLINE - G SUFFIX FOR 8 LEAD TSSOP

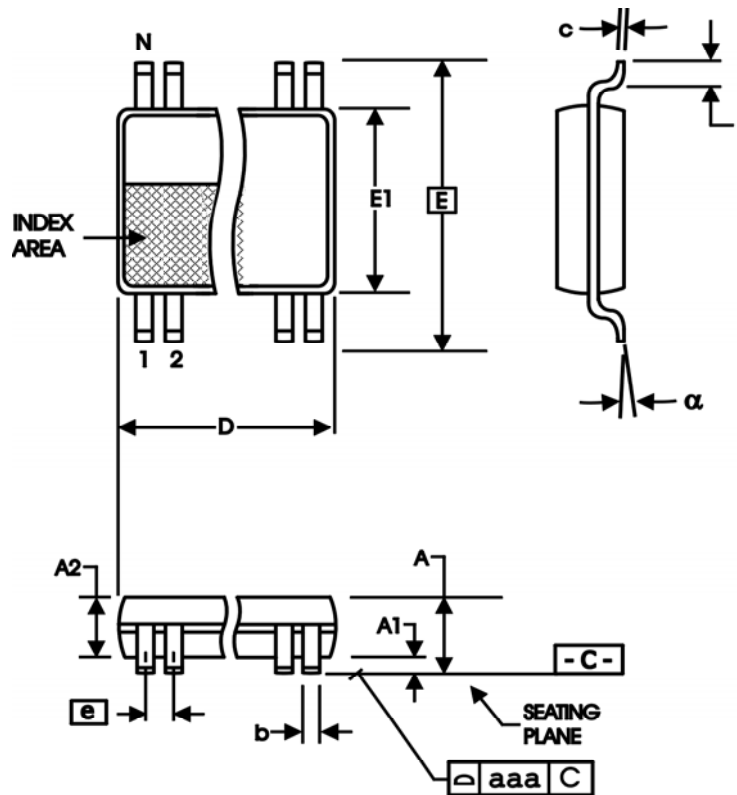

TABLE 7. PACKAGE DIMENSIONS

SYMBOL	Millimeters	
	Minimum	Maximum
N	8	
A	--	1.20
A1	0.05	0.15
A2	0.80	1.05
b	0.19	0.30
c	0.09	0.20
D	2.90	3.10
E	6.40 BASIC	
E1	4.30	4.50
e	0.65 BASIC	
L	0.45	0.75
α	0°	8°
aaa	--	0.10

Reference Document: JEDEC Publication 95, MO-153



**TABLE 8. ORDERING INFORMATION**

Part/Order Number	Marking	Package	Shipping Packaging	Temperature
ICS83052AGI	052AI	8 lead TSSOP	tube	-40°C to 85°C
ICS83052AGIT	052AI	8 lead TSSOP	2500 tape & reel	-40°C to 85°C
ICS83052AGILF	TBD	8 lead "Lead-Free" TSSOP	tube	-40°C to 85°C
ICS83052AGILFT	TBD	8 lead "Lead-Free" TSSOP	2500 tape & reel	-40°C to 85°C

NOTE: Parts that are ordered with an "LF" suffix to the part number are the Pb-Free configuration and are RoHS compliant.

The aforementioned trademark, HiPerClockS is a trademark of Integrated Circuit Systems, Inc. or its subsidiaries in the United States and/or other countries. While the information presented herein has been checked for both accuracy and reliability, Integrated Circuit Systems, Incorporated (ICS) assumes no responsibility for either its use or for infringement of any patents or other rights of third parties, which would result from its use. No other circuits, patents, or licenses are implied. This product is intended for use in normal commercial and industrial applications. Any other applications such as those requiring high reliability or other extraordinary environmental requirements are not recommended without additional processing by ICS. ICS reserves the right to change any circuitry or specifications without notice. ICS does not authorize or warrant any ICS product for use in life support devices or critical medical instruments.