

64Mx64 DDR2 SDRAM w/ SHARED CONTROL BUS INTEGRATED Plastic Encapsulated Microcircuit

FEATURES

- DDR2 Data rate = 667, 533, 400
- Available in Industrial, Enhanced and Military Temp
- Package:
 - Proprietary Enhanced Die Stacked iPEM
 - 208 Plastic Ball Grid Array (PBGA), 16 x 23mm
 - 1.00mm ball pitch
- Differential data strobe (DQS, DQS#) per byte
- Internal, pipelined, double data rate architecture
- 4n-bit prefetch architecture
- DLL for alignment of DQ and DQS transitions with clock signal
- Eight internal banks for concurrent operation (Per DDR2 SDRAM Die)
- Programmable Burst lengths: 4 or 8
- Auto Refresh and Self Refresh Modes (I/T Version)
- On Die Termination (ODT)
- Adjustable data – output drive strength
- 1.8V \pm 0.1V common core power and I/O supply
- Programmable CAS latency: 3, 4, 5, 6 or 7
- Posted CAS additive latency: 0, 1, 2, 3, 4 or 5
- Write latency = Read latency - 1* tCK
- Organized as 64M x 64
- Weight: AS4DDR264M64PBG1 ~ 2.0 grams typical

BENEFITS

- 58% Space Savings
- 49% I/O reduction vs Individual CSP approach
- Reduced part count
- Reduced trace lengths for lower parasitic capacitance
- Suitable for hi-reliability applications
- Upgradable to 128M x 64 density in future

NOTE: Self Refresh Mode available on Industrial and Enhanced temp. only



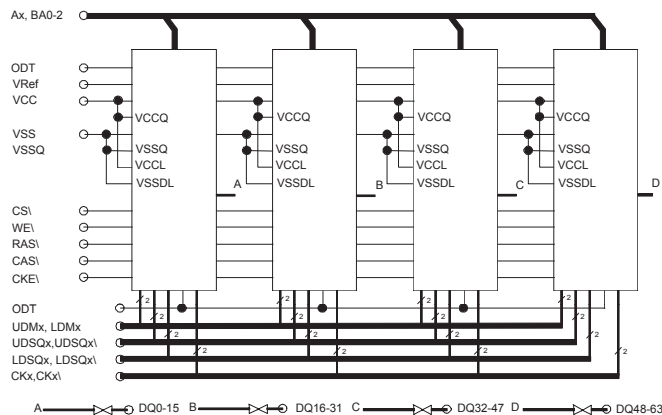





FUNCTIONAL BLOCK DIAGRAM



SDRAM-DDR2 Pinout Top View

Rev. A, 5/08, 208BGA-1.00MM PITCH - X64

	1	2	3	4	5	6	7	8	9	10	11	
A		Vcc	Vss	Vcc	Vcc	Vss	Vcc	Vcc	Vss	Vcc	Vss	A
B	Vcc	Vss	NC	NC	NC	NC	NC	NC	NC	Vss	Vcc	B
C	Vss	NC	NC	NC	NC	NC	NC	DQ34	CK3	CK3\	Vss	C
D	DQ35	DQ51	NC	NC	NC	NC	DQ50	DQ53	DQ37	CK2\	CK2	D
E	DQ52	DQ36	DQ33	NC	BA2	NC	DQ39	LDQS2	LDQS3	DQ48	DQ32	E
F	LDM3	LDM2	DQ49	DQ43	DQ59	NC	DQ55	DQ58	DQ42	LDQS2\	LDQS3\	F
G	DQ38	DQ54	DQ60	DQ57	UDM2	Vss	DQ63	DQ56	DQ40	DQ61	DQ45	G
H	UDM3	DQ44	DQ41	DQ46	DQ62	Vcc	UDQS2\	DQ47	UDQS2	UDQS3	UDQS3\	H
J	Vcc	A6	A10	A9	Vcc	Vss	Vcc	A3	A12	RFU	Vcc	J
K	Vss	A0	A11	Vcc	Vss	Vref	Vss	Vcc	A1	BA1	Vss	K
L	Vcc	A2	A4	A8	Vcc	Vss	Vcc	BA0	A5	A7	Vcc	L
M	UDQS1\	UDQS1	UDQS0	DQ15	UDQS0\	Vcc	DQ30	DQ14	DQ9	DQ12	UDM1	M
N	DQ13	DQ29	DQ8	DQ24	DQ31	Vss	UDM0	DQ25	DQ28	DQ22	DQ6	N
P	LDQS1\	LDQS0\	DQ10	DQ26	DQ23	ODT	DQ27	DQ11	DQ17	LDM0	LDM1	p
R	DQ0	DQ16	LDQS1	LDQS0	DQ7	NC	NC	NC	DQ1	DQ4	DQ20	R
T	CK0	CK0\	DQ5	DQ21	DQ18	NC	NC	CKE	WE\	DQ19	DQ3	T
U	Vss	CK1\	CK1	DQ2	RAS\	CAS\	NC	NC	NC	NC	Vss	U
V	Vcc	Vss	NC	NC	CS\	NC	NC	NC	NC	Vss	Vcc	V
W	Vss	Vcc	Vss	Vcc	Vcc	Vss	Vcc	Vcc	Vss	Vcc	Vss	W
	1	2	3	4	5	6	7	8	9	10	11	

 Ground	 Array Power	 UNPOPULATED	 Address
 CNTRL	 Level REF.	 NC	 RFU
 Data I/O			



BGA Locations	Symbol	Type	Description
P6	ODT	CNTL Input	On-Die-Termination: Registered High enables on data bus termination
C9,C10,D10,D11,T1,T2,U2,U3	CKx, CKx\	CNTL Input	Differential input clocks, one set for each x16bits
T8	CKE	CNTL Input	Clock enable which activates all on silicon clocking circuitry
V5	CS\	CNTL Input	Chip Selects, one for each 16 bits of the data bus width
U5	RAS\	CNTL Input	Command input which along with CAS\, WE\ and CS\ define operations
U6	CAS\	CNTL Input	Command input which along with RAS\, WE\ and CS\ define operations
T9	WE\	CNTL Input	Command input which along with RAS\, CAS\ and CS\ define operations
G5,H1,M11,N7	UDMx	CNTL Input	One Data Mask cntl. for each upper 8 bits of a x16 word
F1,F2,P10,P11	LDMx	CNTL Input	One Data Mask cntl. For each lower 8 bits of a x16 word
H9,H10,M2,M3	UDQSx	CNTL Input	Data Strobe input for upper byte of each x16 word
H7,H11,M1,M5	UDQSx\	CNTL Input	Differential input of UDQSx, only used when Differential DQS mode is enabled
E8,E9,R3,R4,T6	LDQSx	CNTL Input	Data Strobe input for lower byte of each x16 word
F10,F11,P1,P2	LDQSx\	CNTL Input	Differential input of LDQSx, only used when Differential DQS mode is enabled
J2,J3,J4,J8,J9,J10,K2,K3,K9,L2,L3,L4,L9,L10	Ax	Input	Array Address inputs providing ROW addresses for Active commands, and the column address and auto precharge bit (A10) for READ/WRITE commands
J10	RFU	Future Input	
L8,K10,E5	BA0,BA1,BA2	Input	Bank Address inputs
C8,D1,D2,D7,D8,D9,E1,E2,E3,E7,E10,E11,F3,F4,F5,F7,F8,F9,G1,G2,G3,G4,G7,G8,G9,G10,G11,H2,H3,H4,H5,H8,M4,M7,M8,M9,M10,N1,N2,N3,N4,N5,N8,N9,N10,N11,P3,P4,P5,P7,P8,P9,R1,R2,R5,R9,R10,R11,T3,T4,T5,T10,T11,U4	DQx	Input/Output	Data bidirectional input/Output pins
K6	Vref	Supply	SSTL_18 Voltage Reference
A2,A4,A5,A7,A8,A10,B1,B11,H6,J1,J5,J7,J11,K4,K8,L1,L5,L7,L11,M6,V1,V11,W2,W4,W5,W7,W8,W10	VCC	Supply	Core Power Supply
A3,A6,A9,A11,B2,B10,C1,C11,G6,J6,K1,K5,K7,K11,L6,N6,U1,U11,V2,V10,W1,W3,W6,W9,W11	VSS	Supply	Core Ground return
B3,B4,B5,B6,B7,B8,B9,C2,C3,C4,C5,C6,C7,D3,D4,D5,D6,E4,E5,F6,R6,R7,R8,T6,T7,U7,U8,U9,U10,V3,V4,V6,V7,V8,V9	NC		No connection
A1	UNPOPULATED		Unpopulated ball matrix location (location registration aid)

DESCRIPTION

The 4.2Gb DDR2 SDRAM, a high-speed CMOS, dynamic random-access memory containing 4,294,967,296 bits. Each of the four chips in the MCP are internally configured as 8-bank DRAM. The block diagram of the device is shown in Figure 2. Ball assignments and are shown in Figure 3.

The 4.2Gb DDR2 SDRAM uses a double-data-rate architecture to achieve high-speed operation. The double data rate architecture is essentially a $4n$ -prefetch architecture, with an interface designed to transfer two data words per clock cycle at the I/O balls. A single read or write access for the x64 DDR2 SDRAM effectively consists of a single $4n$ -bit-wide, one-clock-cycle data transfer at the internal DRAM core and four corresponding n -bit-wide, one-half-clock-cycle data transfers at the I/O balls.

A bidirectional data strobe (DQS, DQS#) is transmitted externally, along with data, for use in data capture at the receiver. DQS is a strobe transmitted by the DDR2 SDRAM during READs and by the memory controller during WRITEs. DQS is edge-aligned with data for READs and center-aligned with data for WRITEs. There are strobes, one for the lower byte (LDQS, LDQS#) and one for the upper byte (UDQS, UDQS#).

The MCP DDR2 SDRAM operates from a differential clock (CK and CK#); the crossing of CK going HIGH and CK# going LOW will be referred to as the positive edge of CK. Commands (address and control signals) are registered at every positive edge of CK. Input data is registered on both edges of DQS, and output data is referenced to both edges of DQS, as well as to both edges of CK.

Read and write accesses to the DDR2 SDRAM are burst oriented; accesses start at a selected location and continue for a programmed number of locations in a programmed sequence. Accesses begin with the registration of an ACTIVE command, which is then followed by a READ or WRITE command. The address bits registered coincident with the ACTIVE command are used to select the bank and row to be accessed. The address bits registered coincident with the READ or WRITE command are used to select the bank and the starting column location for the burst access.

The DDR2 SDRAM provides for programmable read or write burst lengths of four or eight locations. DDR2 SDRAM supports interrupting a burst read of eight with another read, or a burst write of eight with another write.

An auto precharge function may be enabled to provide a self-timed row precharge that is initiated at the end of the burst access.

As with standard DDR SDRAMs, the pipelined, multibank architecture of DDR2 SDRAMs allows for concurrent operation, thereby providing high, effective bandwidth by hiding row precharge and activation time.

A self refresh mode is provided, along with a power-saving power-down mode.

All inputs are compatible with the JEDEC standard for SSTL_18. All full drive-strength outputs are SSTL_18-compatible.

GENERAL NOTES

- The functionality and the timing specifications discussed in this data sheet are for the DLLenabled mode of operation.
- Throughout the data sheet, the various figures and text refer to DQs as DQ. The DQ term is to be interpreted as any and all DQ collectively, unless specifically stated otherwise. Additionally, each chip is divided into 2 bytes, the lower byte and upper byte. For the lower byte (DQ0 CDQ7), DM refers to LDM and DQS refers to LDQS. For the upper byte (DQ8 CDQ15), DM refers to UDM and DQS refers to UDQS.
- Complete functionality is described throughout the document and any page or diagram may have been simplified to convey a topic and may not be inclusive of all requirements.
- Any specific requirement takes precedence over a general statement.

INITIALIZATION

DDR2 SDRAMs must be powered up and initialized in a predefined manner. Operational procedures other than those specified may result in undefined operation. The following sequence is required for power up and initialization and is shown in Figure 4 on page 5.

FIGURE 4 - POWER-UP AND INITIALIZATION
Notes appear on page 7

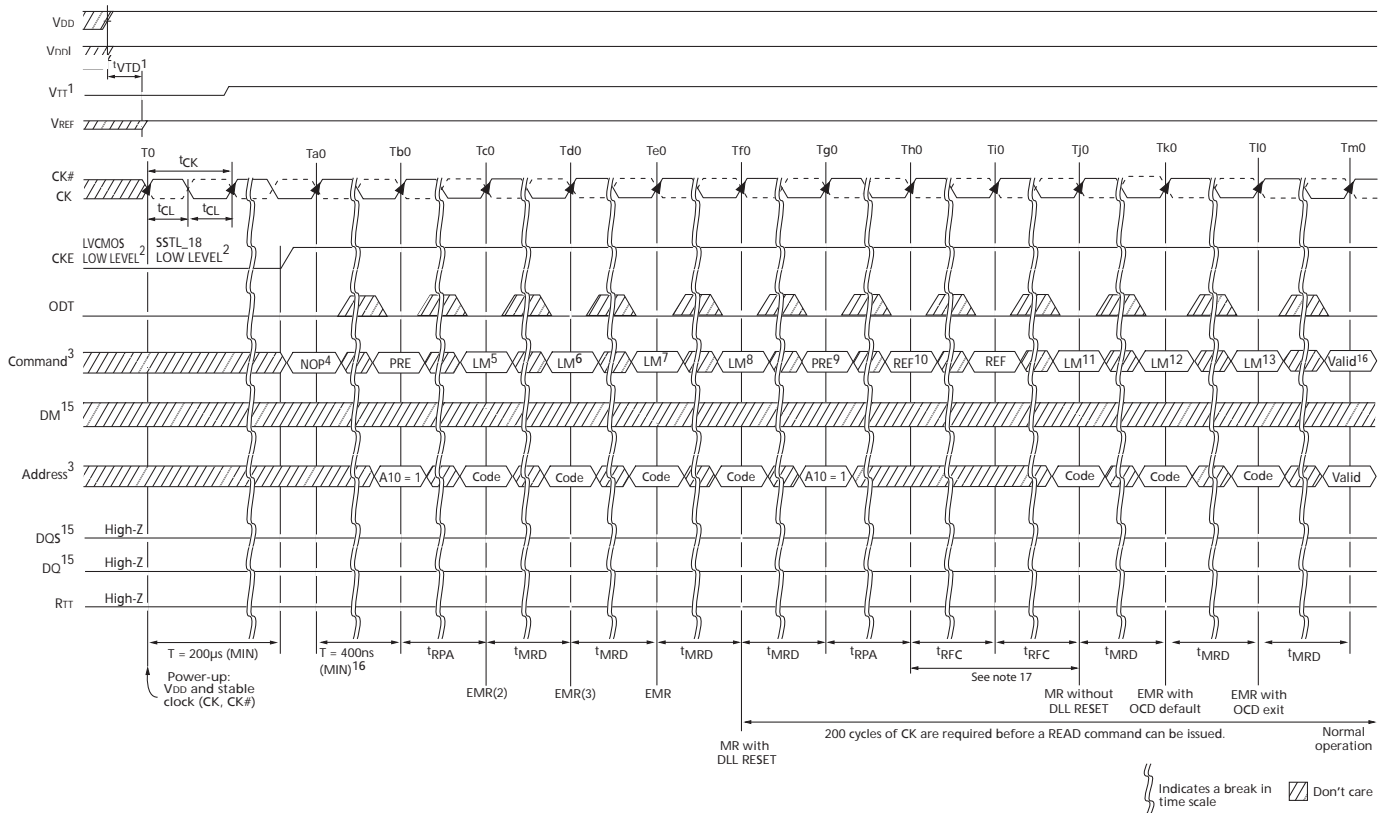



NOTES:

- Applying power; if CKE is maintained below $0.2 \times VCCQ$, outputs remain disable. To guarantee RTT (ODT Resistance) is off, VREF must be valid and a low level must be applied to the ODT ball (all other inputs may be undefined, I/Os and outputs must be less than VCCQ during voltage ramp time to avoid DDR2 SDRAM device latch-up). VTT is not applied directly to the device; however, tVTD should be ≈ 0 to avoid device latch-up. At least one of the following two sets of conditions (A or B) must be met to obtain a stable supply state (stable supply defined as VCC, VCCQ, VREF, and VTT are between their minimum and maximum values as stated in DC Operating Condition table):
 - (single power source) The VCC voltage ramp from 300mV to VCC(MIN) must take no longer than 200ms; during the VCC voltage ramp, $|VCC - VCCQ| < 0.3V$. Once supply voltage ramping is complete (when VCCQ crosses VCC (MIN)), DC Operating Conditions table specifications apply.
 - VCC, VCCQ are driven from a single power converter output
 - VTT is limited to 0.95V MAX
 - VREF tracks VCCQ/2; VREF must be within $\pm 3V$ with respect to VCCQ/2 during supply ramp time.
 - VCCQ > VREF at all times
 - (multiple power sources) VCC e" VCCQ must be maintained during supply voltage ramping, for both AC and DC levels, until supply voltage ramping completes (VCCQ crosses VCC [MIN]). Once supply voltage ramping is complete, DC Operating Conditions table specifications apply.
 - Apply VCC before or at the same time as VCCQ; VCC voltage ramp time must be < 200ms from when VCC ramps from 300mV to VCC (MIN)
 - Apply VCCQ before or at the same time as VTT; the VCCQ voltage ramp time from when VCC (MIN) is achieved to when VCCQ (MIN) is achieved must be < 500ms; while VCC is ramping, current can be supplied from VCC through the device to VCCQ
 - VREF must track VCCQ/2, VREF must be within $\pm 0.3V$ with respect to VCCQ/2 during supply ramp time; VCCQ > VREF must be met at all times
 - Apply VTT; The VTT voltage ramp time from when VCCQ (MIN) is achieved to when VTT (MIN) is achieved must be no greater than 500ms
- CKE requires LVCMOS input levels prior to state T0 to ensure DQs are High-Z during device power-up prior to VREF being stable. After state T0, CKE is required to have SSTL_18 input levels. Once CKE transitions to a high level, it must stay HIGH for the duration of the initialization sequence.
- A10 = PRECHARGE ALL, CODE = desired values for mode registers (bank addresses are required to be decoded).
- For a minimum of 200 μ s after stable power and clock (CK, CK#), apply NOP or DESELECT commands, then take CKE HIGH.
- Issue a LOAD MODE command to the EMR(2). To issue an EMR(2) command, provide LOW to BA0, and provide HIGH to BA1; set register E7 to "0" or "1" to select appropriate self refresh rate; remaining EMR(2) bits must be "0" (see "Extended Mode Register 2 (EMR2)" on page 84 for all EMR(2) requirements).
- Issue a LOAD MODE command to the EMR(3). To issue an EMR(3) command, provide HIGH to BA0 and BA1; remaining EMR(3) bits must be "0." See "Extended Mode Register 3 (EMR 3)" on page 13 for all EMR(3) requirements.
- Issue a LOAD MODE command to the EMR to enable DLL. To issue a DLL ENABLE command, provide LOW to BA1 and A0; provide HIGH to BA0; bits E7, E8, and E9 can be set to "0" or "1;" Austin recommends setting them to "0;" remaining EMR bits must be "0." See "Extended Mode Register (EMR)" on page 10 for all EMR requirements.
- Issue a LOAD MODE command to the MR for DLL RESET. 200 cycles of clock input is required to lock the DLL. To issue a DLL RESET, provide HIGH to A8 and provide LOW to BA1 and BA0; CKE must be HIGH the entire time the DLL is resetting; remaining MR bits must be "0." See "Mode Register (MR)" on page 7 for all MR requirements.
- Issue PRECHARGE ALL command.
- Issue two or more REFRESH commands.
- Issue a LOAD MODE command to the MR with LOW to A8 to initialize device operation (that is, to program operating parameters without resetting the DLL). To access the MR, set BA0 and BA1 LOW; remaining MR bits must be set to desired settings. See "Mode Register (MR)" on page 7 for all MR requirements.
- Issue a LOAD MODE command to the EMR to enable OCD default by setting bits E7, E8, and E9 to "1," and then setting all other desired parameters. To access the EMR, set BA0 LOW and BA1 HIGH (see "Extended Mode Register (EMR)" on page 10 for all EMR requirements).
- Issue a LOAD MODE command to the EMR to enable OCD exit by setting bits E7, E8, and E9 to "0," and then setting all other desired parameters. To access the extended mode registers, EMR, set BA0 LOW and BA1 HIGH for all EMR requirements.
- The DDR2 SDRAM is now initialized and ready for normal operation 200 clock cycles after the DLL RESET at Tf0.
- DM represents UDM, LDM collectively for each die x16 configuration. DQS represents UDQS, USQS, LDQS, LDQS for each die x16 configuration. DQ represents DQ0-DQ15 for each die x16 configuration.
- Wait a minimum of 400ns then issue a PRECHARGE ALL command.

MODE REGISTER (MR)

The mode register is used to define the specific mode of operation of the DDR2 SDRAM. This definition includes the selection of a burst length, burst type, CL, operating mode, DLL RESET, write recovery, and power-down mode, as shown in Figure 5. Contents of the mode register can be altered by re-executing the LOAD MODE (LM) command. If the user chooses to modify only a subset of the MR variables, all variables (M0–M14) must be programmed when the command is issued.

The mode register is programmed via the LM command (bits BA2–BA0 = 0, 0,0) and other bits (M13–M0) will retain the stored information until it is programmed again or the device loses power (except for bit M8, which is selfclearing). Reprogramming the mode register will not alter the contents of the memory array, provided it is performed correctly.

The LM command can only be issued (or reissued) when all banks are in the precharged state (idle state) and no bursts are in progress. The controller must wait the specified time tMRD before initiating any subsequent operations such as an ACTIVE command. Violating either of these requirements will result in unspecified operation.

BURST LENGTH

Burst length is defined by bits M0–M3, as shown in Figure 5. Read and write accesses to the DDR2 SDRAM are burst-oriented, with the burst length being programmable to either four or eight. The burst length determines the maximum number of column locations that can be accessed for a given READ or WRITE command.

When a READ or WRITE command is issued, a block of columns equal to the burst length is effectively selected. All accesses for that burst take place within this block, meaning that the burst will wrap within the block if a boundary is reached. The block is uniquely selected by A2–Ai when BL = 4 and by A3–Ai when BL = 8 (where Ai is the most significant column address bit for a given configuration). The remaining (least significant) address bit(s) is (are) used to select the starting location within the block. The programmed burst length applies to both READ and WRITE bursts.

BURST TYPE

Accesses within a given burst may be programmed to be either sequential or interleaved. The burst type is selected via bit M3, as shown in Figure 5. The ordering of accesses within a burst is determined by the burst length, the burst type, and the starting column address, as shown in Table 2. DDR2 SDRAM supports 4-bit burst mode and 8-bit burst mode only. For 8-bit burst mode, full interleave address ordering is supported; however, sequential address ordering is nibble-based.

FIGURE 5 – MODE REGISTER (MR) DEFINITION

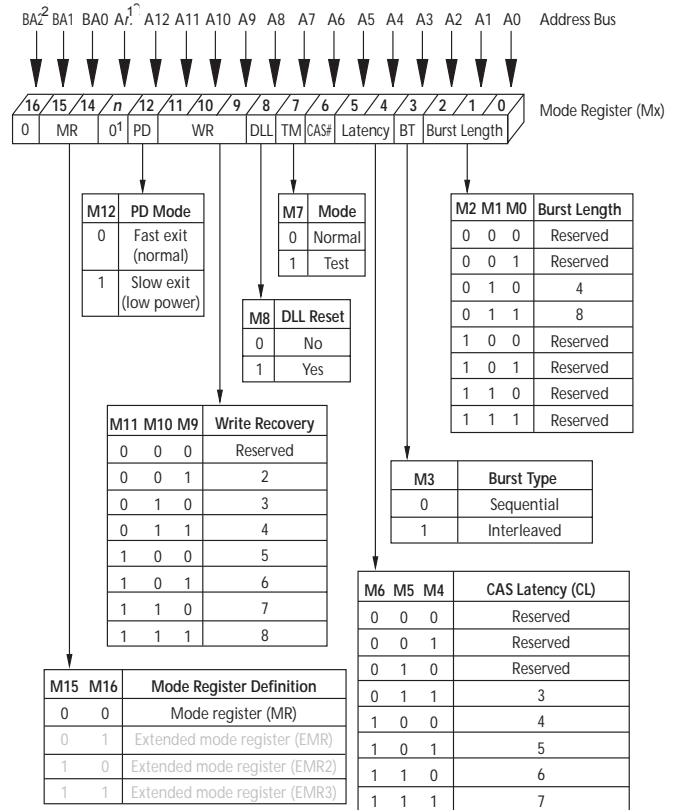

Notes:

1. A13 Not used on this part, and must be programmed to '0' on this part.
2. BA2 must be programmed to "0" and is reserved for future use.

TABLE 2 - BURST DEFINITION

Burst Length	Starting Column Address		Order of Accesses Within a Burst		
			Type = Sequential	Type = Interleaved	
4	A1	A0			
	0	0	0-1-2-3	0-1-2-3	
	0	1	1-2-3-0	1-0-3-2	
	1	0	2-3-0-1	2-3-0-1	
	1	1	3-0-1-2	3-2-1-0	
8	A2	A1	A0		
	0	0	0	0-1-2-3-4-5-6-7	0-1-2-3-4-5-6-7
	0	0	1	1-2-3-4-5-6-7-0	1-0-3-2-5-4-7-6
	0	1	0	2-3-4-5-6-7-0-1	2-3-0-1-6-7-4-5
	0	1	1	3-4-5-6-7-0-1-2	3-2-1-0-7-6-5-4
	1	0	0	4-5-6-7-0-1-2-3	4-5-6-7-0-1-2-3
	1	0	1	5-6-7-0-1-2-3-4	5-4-7-6-1-0-3-2
	1	1	0	6-7-0-1-2-3-4-5	6-7-4-5-2-3-0-1
1	1	1	7-0-1-2-3-4-5-6	7-6-5-4-3-2-1-0	

NOTES:

- For a burst length of two, A1-Ai select two-data-element block; A0 selects the starting column within the block.
- For a burst length of four, A2-Ai select four-data-element block; A0-1 select the starting column within the block.
- For a burst length of eight, A3-Ai select eight-data-element block; A0-2 select the starting column within the block.
- Whenever a boundary of the block is reached within a given sequence above, the following access wraps within the block.

OPERATING MODE

The normal operating mode is selected by issuing a command with bit M7 set to “0” and all other bits set to the desired values, as shown in Figure 5. When bit M7 is “1,” no other bits of the mode register are programmed. Programming bit M7 to “1” places the DDR2 SDRAM into a test mode that is only used by the manufacturer and should not be used. No operation or functionality is guaranteed if M7 bit is “1.”

DLL RESET

DLL RESET is defined by bit M8, as shown in Figure 5. Programming bit M8 to “1” will activate the DLL RESET function. Bit M8 is self-clearing, meaning it returns back to a value of “0” after the DLL RESET function has been issued.

Anytime the DLL RESET function is used, 200 clock cycles must occur before a READ command can be issued to allow time for the internal clock to be synchronized with the external clock. Failing to wait for synchronization to occur may result in a violation of the tAC or tDQCK parameters.

WRITE RECOVERY

Write recovery (WR) time is defined by bits M9-M11, as shown in Figure 5. The WR register is used by the DDR2 SDRAM during WRITE with auto precharge operation. During WRITE with auto precharge operation, the DDR2 SDRAM delays the internal auto precharge operation by WR clocks (programmed in bits M9-M11) from the last data burst.

WR values of 2, 3, 4, 5, 6 or 7 clocks may be used for programming bits M9-M11. The user is required to program the value of WR, which is calculated by dividing tWR (in ns) by tCK (in ns) and rounding up a non integer value to the next integer; $WR [cycles] = \lceil tWR [ns] / tCK [ns] \rceil$. Reserved states should not be used as unknown operation or incompatibility with future versions may result.

POWER-DOWN MODE

Active power-down (PD) mode is defined by bit M12, as shown in Figure 5. PD mode allows the user to determine the active power-down mode, which determines performance versus power savings. PD mode bit M12 does not apply to precharge PD mode.

When bit M12 = 0, standard active PD mode or “fast-exit” active PD mode is enabled. The tXARD parameter is used for fast-exit active PD exit timing. The DLL is expected to be enabled and running during this mode.

When bit M12 = 1, a lower-power active PD mode or “slowexit” active PD mode is enabled. The tXARD parameter is used for slow-exit active PD exit timing. The DLL can be enabled, but “frozen” during active PD mode since the exit-to-READ command timing is relaxed. The power difference expected between PD normal and PD low-power mode is defined in the Icc table.

CAS LATENCY (CL)

The CAS latency (CL) is defined by bits M4-M6, as shown in Figure 5. CL is the delay, in clock cycles, between the registration of a READ command and the availability of the first bit of output data. The CL can be set to 3, 4, 5, 6 or 7 clocks, depending on the speed grade option being used.

DDR2 SDRAM does not support any half-clock latencies. Reserved states should not be used as unknown operation or incompatibility with future versions may result.

DDR2 SDRAM also supports a feature called posted CAS additive latency (AL). This feature allows the READ command to be issued prior to tRCD (MIN) by delaying the internal command to the DDR2 SDRAM by AL clocks.

Examples of CL = 3 and CL = 4 are shown in Figure 6; both assume AL = 0. If a READ command is registered at clock edge n , and the CL is m clocks, the data will be available nominally coincident with clock edge $n+m$ (this assumes AL = 0).

FIGURE 6 - CAS LATENCY (CL)

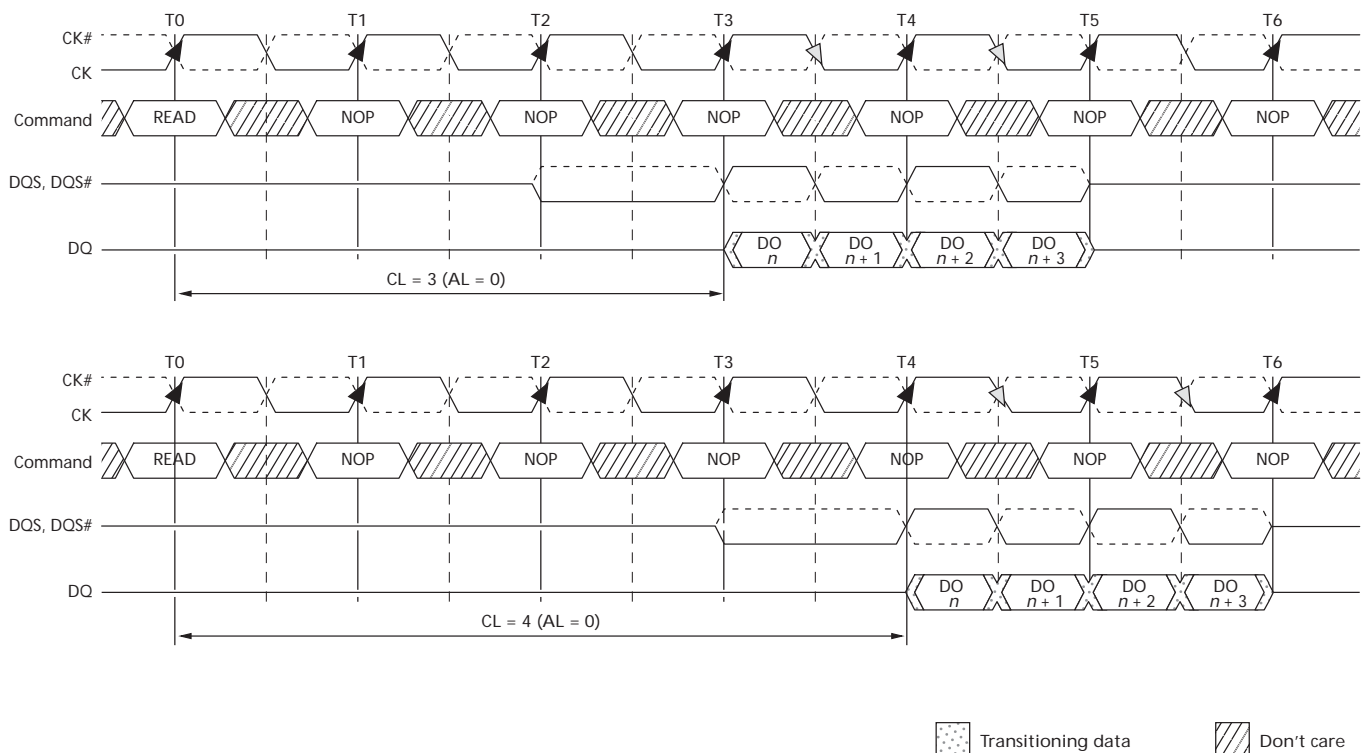

- Notes:
1. BL = 4.
 2. Posted CAS# additive latency (AL) = 0.
 3. Shown with nominal t_{AC} , t_{DQSCk} , and t_{DQSQ} .

EXTENDED MODE REGISTER (EMR)

The extended mode register controls functions beyond those controlled by the mode register; these additional functions are DLL enable/disable, output drive strength, on die termination (ODT) (RTT), posted AL, off-chip driver impedance calibration (OCD), DQS# enable/disable, RDQS/RDQS# enable/disable, and output disable/enable. These functions are controlled via the bits shown in Figure 7. The EMR is programmed via the LOAD MODE (LM) command and will retain the stored information

until it is programmed again or the device loses power. Reprogramming the EMR will not alter the contents of the memory array, provided it is performed correctly.

The EMR must be loaded when all banks are idle and no bursts are in progress, and the controller must wait the specified time tMRD before initiating any subsequent operation. Violating either of these requirements could result in unspecified operation.

FIGURE 7 – EXTENDED MODE REGISTER DEFINITION

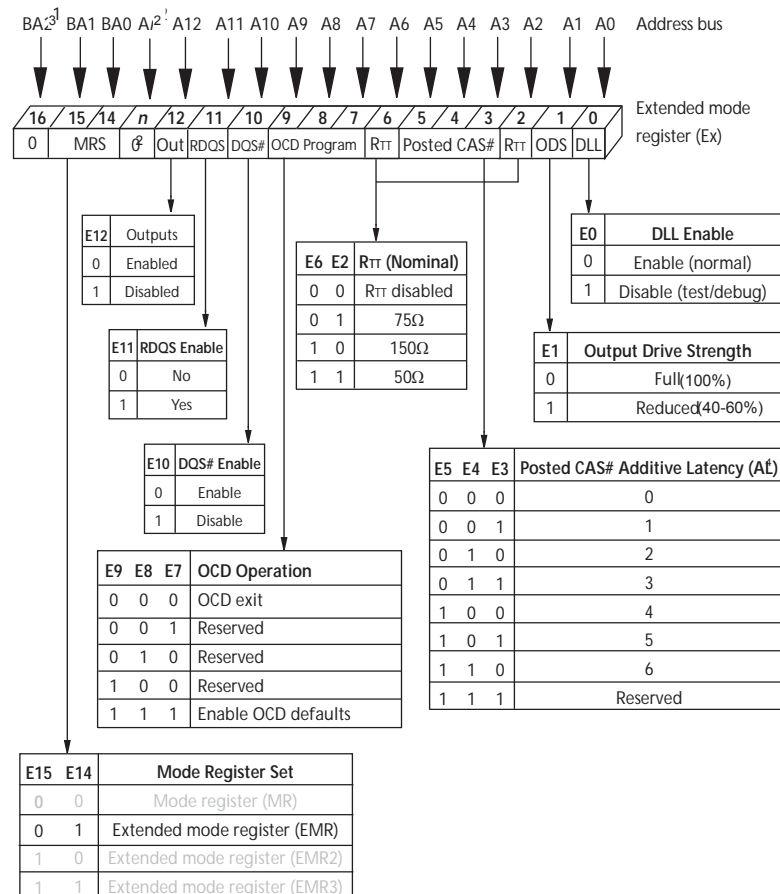

Notes:

1. During initialization, all three bits must be set to "1" for OCD default state, then must be set to "0" before initialization is finished, as detailed in the initialization procedure.
2. E₁₃ (A₁₃) must be programmed to "0" and is reserved for future use.
3. E₁₆ must be programmed to "0" and is reserved for future use.
4. Not all AL options are supported in any individual speed grade.

DLL ENABLE/DISABLE

The DLL may be enabled or disabled by programming bit E0 during the LM command, as shown in Figure 7. The DLL must be enabled for normal operation. DLL enable is required during power-up initialization and upon returning to normal operation after having disabled the DLL for the purpose of debugging or evaluation. Enabling the DLL should always be followed by resetting the DLL using an LM command.

The DLL is automatically disabled when entering SELF REFRESH operation and is automatically re-enabled and reset upon exit of SELF REFRESH operation. Any time the DLL is enabled (and subsequently reset), 200 clock cycles must occur before a READ command can be issued, to allow time for the internal clock to synchronize with the external clock. Failing to wait for synchronization to occur may result in a violation of the 'AC or 'DQSCK parameters.

OUTPUT DRIVE STRENGTH

The output drive strength is defined by bit E1, as shown in Figure 7. The normal drive strength for all outputs are specified to be SSTL_18. Programming bit E1 = 0 selects normal (full strength) drive strength for all outputs. Selecting a reduced drive strength option (E1 = 1) will reduce all outputs to approximately 45-60 percent of the SSTL_18 drive strength. This option is intended for the support of lighter load and/or point-to-point environments.

DQS# ENABLE/DISABLE

The DQS# ball is enabled by bit E10. When E10 = 0, DQS# is the complement of the differential data strobe pair DQS/DQS#. When disabled (E10 = 1), DQS is used in a single ended mode and the DQS# ball is disabled. When disabled, DQS# should be left floating. This function is also used to enable/disable RDQS#. If RDQS is enabled (E11 = 1) and DQS# is enabled (E10 = 0), then both DQS# and RDQS# will be enabled.

OUTPUT ENABLE/DISABLE

The OUTPUT ENABLE function is defined by bit E12, as shown in Figure 7. When enabled (E12 = 0), all outputs (DQs, DQS, DQS#, RDQS, RDQS#) function normally. When disabled (E12 = 1), all DDR2 SDRAM outputs (DQs, DQS, DQS#, RDQS, RDQS#) are disabled, thus removing output buffer current. The output disable feature is intended to be used during Icc characterization of read current.

ON-DIE TERMINATION (ODT)

ODT effective resistance, $R_{TT}(EFF)$, is defined by bits E2 and E6 of the EMR, as shown in Figure 7. The ODT feature is designed to improve signal integrity of the memory channel by allowing the DDR2 SDRAM controller to independently turn on/off ODT for any or all devices. R_{TT} effective resistance values of 50 Ω , 75 Ω , and 150 Ω are selectable and apply to each DQ, DQS/DQS#, RDQS/ RDQS#, UDQS/UDQS#, LDQS/LDQS#, DM, and UDM/ LDM signals. Bits (E6, E2) determine what ODT resistance is enabled by turning on/off "sw1," "sw2," or "sw3." The ODT effective resistance value is elected by enabling switch "sw1," which enables all R1 values that are 150 Ω each, enabling an effective resistance of 75 Ω ($R_{TT2}(EFF) = R2/2$). Similarly, if "sw2" is enabled, all R2 values that are 300 Ω each, enable an effective ODT resistance of 150 Ω ($R_{TT2}(EFF) = R2/2$). Switch "sw3" enables R1 values of 100 Ω enabling effective resistance of 50 Ω . Reserved states should not be used, as unknown operation or incompatibility with future versions may result.

The ODT control ball is used to determine when $R_{TT}(EFF)$ is turned on and off, assuming ODT has been enabled via bits E2 and E6 of the EMR. The ODT feature and ODT input ball are only used during active, active power-down (both fast-exit and slow-exit modes), and precharge powerdown modes of operation. ODT must be turned off prior to entering self refresh. During power-up and initialization of the DDR2 SDRAM, ODT should be disabled until issuing the EMR command to enable the ODT feature, at which point the ODT ball will determine the $R_{TT}(EFF)$ value. Any time the EMR enables the ODT function, ODT may not be driven HIGH until eight clocks after the EMR has been enabled. See "ODT Timing" section for ODT timing diagrams.

POSTED CAS ADDITIVE LATENCY (AL)

Posted CAS additive latency (AL) is supported to make the command and data bus efficient for sustainable bandwidths in DDR2 SDRAM. Bits E3–E5 define the value of AL, as shown in Figure 7. Bits E3–E5 allow the user to program the DDR2 SDRAM with an inverse AL of 0, 1, 2, 3, 4, 5 or 6 clocks. Reserved states should not be used as unknown operation or incompatibility with future versions may result.

In this operation, the DDR2 SDRAM allows a READ or WRITE command to be issued prior to $t_{RCD}(\text{MIN})$ with the requirement that $AL = t_{RCD}(\text{MIN}) - 1 \times t_{CK}$. The READ or WRITE command is held for the time of the AL before it is issued internally to the DDR2 SDRAM device. RL is controlled by the sum of AL and CL; $RL = AL + CL$. Write latency (WL) is equal to RL minus one clock; $WL = AL + CL - 1 \times t_{CK}$.

FIGURE 8 - EXTENDED MODE REGISTER 2 (EMR2) DEFINITION

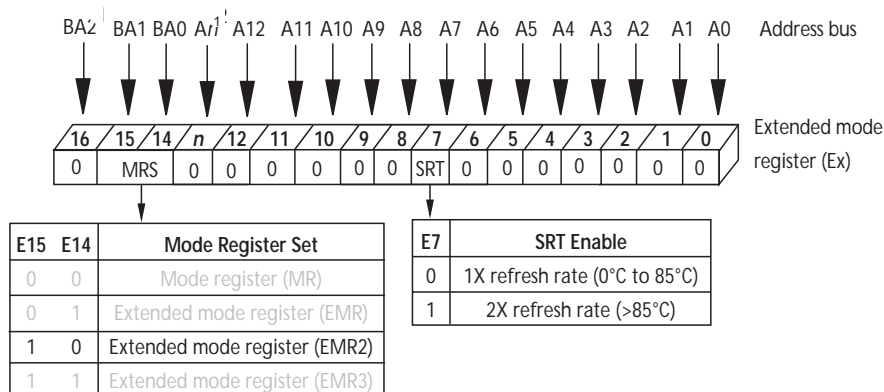

Notes:

1. E16 bit (BA2) must be programmed to “0” and is reserved for future use.
2. Mode bits (En) with corresponding address balls (An) greater than A12 are reserved for future use and must be programmed to “0.”

FIGURE 9 - EXTENDED MODE REGISTER 3 (EMR3) DEFINITION

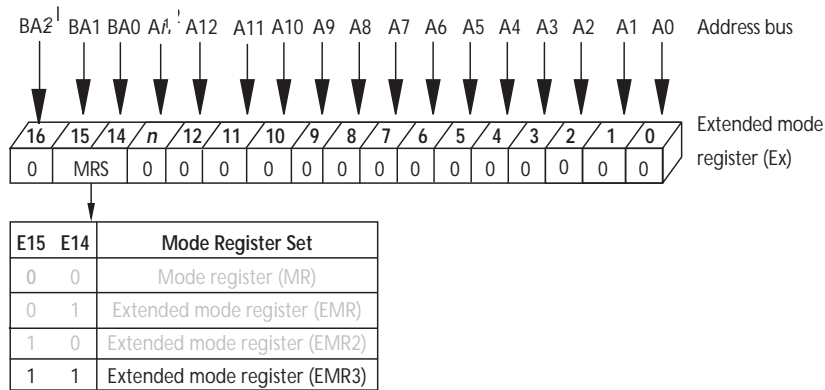

Notes:

1. Mode bits (En) with corresponding address balls (An) greater than A12 are reserved for future use and must be programmed to “0.”
2. E16 (BA2) must be programmed to “0” on this device and is reserved for future use.

EXTENDED MODE REGISTER 2

The extended mode register 2 (EMR2) controls functions beyond those controlled by the mode register. Currently all bits in EMR2 are reserved, as shown in Figure 8. The EMR2 is programmed via the LM command and will retain the stored information until it is programmed again or the device loses power. Reprogramming the EMR will not alter the contents of the memory array, provided it is performed correctly.

EMR2 must be loaded when all banks are idle and no bursts are in progress, and the controller must wait the specified time tMRD before initiating any subsequent operation. Violating either of these requirements could result in unspecified operation.

EXTENDED MODE REGISTER 3

The extended mode register 3 (EMR3) controls functions beyond those controlled by the mode register. Currently, all bits in EMR3 are reserved, as shown in Figure 9. The EMR3 is programmed via the LM command and will retain the stored information until it is programmed again or the device loses power. Reprogramming the EMR will not alter the contents of the memory array, provided it is performed correctly.

EMR3 must be loaded when all banks are idle and no bursts are in progress, and the controller must wait the specified time tMRD before initiating any subsequent operation. Violating either of these requirements could result in unspecified operation.

COMMAND TRUTH TABLES

The following tables provide a quick reference of DDR2 SDRAM available commands, including CKE power-down modes, and bank-to-bank commands.

TABLE 3 - TRUTH TABLE - DDR2 COMMANDS

Function	CKE		CS#	RAS#	CAS#	WE#	BA2 thru BA0	A12 A11	A10	A9-A0	Notes
	Previous Cycle	Current Cycle									
LOAD MODE	H	H	L	L	L	L	BA	OP CODE			2
REFRESH	H	H	L	L	L	H	X	X	X	X	
SELF-REFRESH Entry	H	L	L	L	L	H	X	X	X	X	
SELF-REFRESH exit	L	H	H	X	X	X	X	X	X	X	7
			L	H	H	H					
Single Bank Precharge	H	H	L	L	H	L	X	X	L	X	2
All banks PRECHARGE	H	H	L	L	H	L	X	X	H	X	
Bank Activate	H	H	L	L	H	L	BA	ROW ADDRESS			
WRITE	H	H	L	L	H	L	BA	Column Address	L	Column Address	2,3
WRITE with auto precharge	H	H	L	H	L	L	BA	Column Address	H	Column Address	2,3
READ	H	H	L	H	L	H	BA	Column Address	L	Column Address	2,3
READ with auto precharge	H	H	L	H	L	H	BA	Column Address	L	Column Address	2,3
NO OPERATION	H	X	L	H	H	H	X	X	X	X	
Device DESELECT	H	X	H	X	X	X	X	X	X	X	
POWER-DOWN entry	H	L	H	X	X	X	X	X	X	X	4
			L	H	H	H					
POWER-DOWN exit	L	H	H	X	X	X	X	X	X	X	4
			L	H	H	H					

- Note:
1. All DDR2-SDRAM commands are defined by states of CS#, RAS#, CAS#, WE#, and CKE at the rising edge of the clock.
 2. Bank addresses (BA) BA2-BA0 determine which bank is to be operated upon. BA during a LM command selects which mode register is programmed.
 3. Burst reads or writes at BL=4 cannot be terminated or interrupted.
 4. The power down mode does not perform any REFRESH operations. The duration of power down is therefore limited by the refresh requirements outlined in the AC parametric section.
 5. The state of ODT does not effect the states described in this table. The ODT function is not available during self refresh. See “On Die Termination (ODT)” for details.
 6. “X” means “H or L” (but a defined logic level)
 7. Self refresh exit is asynchronous.

DESELECT

The Deselect function (CS# HIGH) prevents new commands from being executed by the DDR2 SDRAM. The DDR2 SDRAM is effectively deselected. Operations already in progress are not affected.

NO OPERATION (NOP)

The NO OPERATION (NOP) command is used to instruct the selected DDR2 SDRAM to perform a NOP (CS# is LOW; RAS#, CAS#, and WE are HIGH). This prevents unwanted commands from being registered during idle or wait states. Operations already in progress are not affected.

LOAD MODE (LM)

The mode registers are loaded via inputs BA2–BA0, and A12–A0. BA2–BA0 determine which mode register will be programmed. See “Mode Register (MR)”. The LM command can only be issued when all banks are idle, and a subsequent execute able command cannot be issued until tMRD is met.

BANK/ROW ACTIVATION

ACTIVE COMMAND

The ACTIVE command is used to open (or activate) a row in a particular bank for a subsequent access. The value on the BA2–BA0 inputs selects the bank, and the address provided on inputs A12–A0 selects the row. This row remains active (or open) for accesses until a PRECHARGE command is issued to that bank. A PRECHARGE command must be issued before opening a different row in the same bank.

ACTIVE OPERATION

Before any READ or WRITE commands can be issued to a bank within the DDR2 SDRAM, a row in that bank must be opened (activated), even when additive latency is used. This is accomplished via the ACTIVE command, which selects both the bank and the row to be activated.

After a row is opened with an ACTIVE command, a READ or WRITE command may be issued to that row, subject to the tRCD specification. tRCD (MIN) should be divided by the clock period and rounded up to the next whole number to determine the earliest clock edge after the ACTIVE command on which a READ or WRITE command can be entered. The same procedure is used to convert other specification limits from time units to clock cycles. For example, a tRCD (MIN) specification of 20ns with a 266 MHz clock (tCK = 3.75ns) results in 5.3 clocks, rounded up to 6.

A subsequent ACTIVE command to a different row in the same bank can only be issued after the previous active row has been closed (precharged). The minimum time interval between successive ACTIVE commands to the same bank is defined by tRC.

A subsequent ACTIVE command to another bank can be issued while the first bank is being accessed, which results in a reduction of total row-access overhead. The minimum time interval between successive ACTIVE commands to different banks is defined by tRRD.

FIGURE 10 - ACTIVE COMMAND

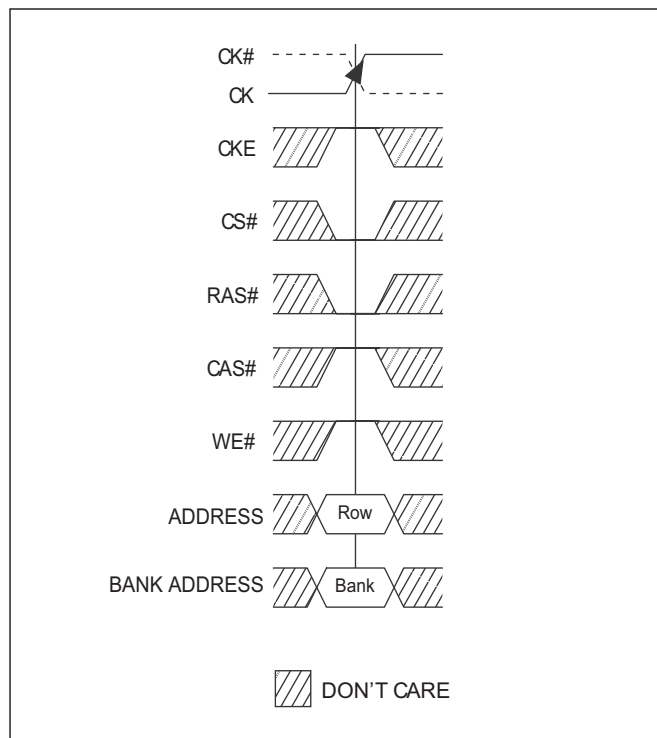

READ COMMAND

The READ command is used to initiate a burst read access to an active row. The value on the BA2–BA0 inputs selects the bank, and the address provided on inputs A0–i (where $i = A9$) selects the starting column location. The value on input A10 determines whether or not auto precharge is used. If auto precharge is selected, the row being accessed will be precharged at the end of the READ burst; if auto precharge is not selected, the row will remain open for subsequent accesses.

READ OPERATION

READ bursts are initiated with a READ command. The starting column and bank addresses are provided with the READ command and auto precharge is either enabled or disabled for that burst access. If auto precharge is enabled, the row being accessed is automatically precharged at the completion of the burst. If auto precharge is disabled, the row will be left open after the completion of the burst.

During READ bursts, the valid data-out element from the starting column address will be available READ latency (RL) clocks later. RL is defined as the sum of AL and CL; $RL = AL + CL$. The value for AL and CL are programmable via the MR and EMR commands, respectively. Each subsequent data-out element will be valid nominally at the next positive or negative clock edge (i.e., at the next crossing of CK and CK#).

DQS/DQS# is driven by the DDR2 SDRAM along with output data. The initial LOW state on DQS and HIGH state on DQS# is known as the read preamble (iRPRE). The LOW state on DQS and HIGH state on DQS# coincident with the last data-out element is known as the read postamble (iRPST).

Upon completion of a burst, assuming no other commands have been initiated, the DQ will go High-Z.

Data from any READ burst may be concatenated with data from a subsequent READ command to provide a continuous flow of data. The first data element from the new burst follows the last element of a completed burst. The new READ command should be issued x cycles after the first READ command, where x equals $BL / 2$ cycles.

FIGURE 11 - READ COMMAND

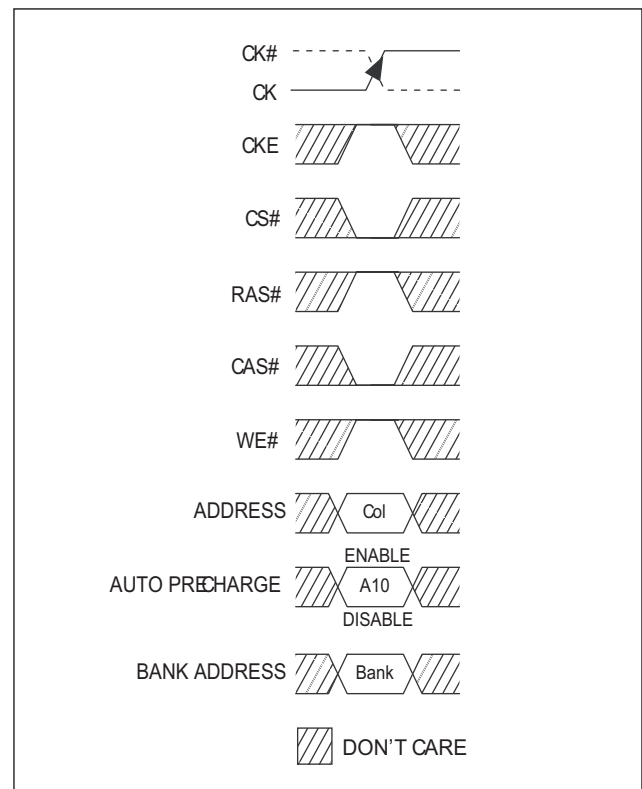

WRITE COMMAND

The WRITE command is used to initiate a burst write access to an active row. The value on the BA2–BA0 inputs selects the bank, and the address provided on inputs A0–9 selects the starting column location. The value on input A10 determines whether or not auto precharge is used. If auto precharge is selected, the row being accessed will be precharged at the end of the WRITE burst; if auto precharge is not selected, the row will remain open for subsequent accesses.

Input data appearing on the DQ is written to the memory array subject to the DM input logic level appearing coincident with the data. If a given DM signal is registered LOW, the corresponding data will be written to memory; if the DM signal is registered HIGH, the corresponding data inputs will be ignored, and a WRITE will not be executed to that byte/column location.

WRITE OPERATION

WRITE bursts are initiated with a WRITE command, as shown in Figure 12. DDR2 SDRAM uses WL equal to RL minus one clock cycle [WL = RL - 1CK = AL + (CL - 1CK)]. The starting column and bank addresses are provided with the WRITE command, and auto precharge is either enabled or disabled for that access. If auto precharge is enabled, the row being accessed is precharged at the completion of the burst. For the generic WRITE commands used in the following illustrations, auto precharge is disabled.

During WRITE bursts, the first valid data-in element will be registered on the first rising edge of DQS following the WRITE command, and subsequent data elements will be registered on successive edges of DQS. The LOW state on DQS between the WRITE command and the first rising edge is known as the write preamble; the LOW state on DQS following the last data-in element is known as the write postamble.

The time between the WRITE command and the first rising DQS edge is $WL \pm t_{DQSS}$. Subsequent DQS positive rising edges are timed, relative to the associated clock edge, as $\pm t_{DQSS}$. t_{DQSS} is specified with a relatively wide range (25 percent of one clock cycle). All of the WRITE diagrams show the nominal case, and where the two extreme cases (t_{DQSS} [MIN] and t_{DQSS} [MAX]) might not be intuitive, they have also been included. Upon completion of a burst, assuming no other commands have been initiated, the DQ will remain High-Z and any additional input data will be ignored.

Data for any WRITE burst may be concatenated with a subsequent WRITE command to provide continuous flow of input data. The first data element from the new burst is applied after the last element of a completed burst. The new WRITE command should be issued x cycles after the first WRITE command, where x equals BL/2.

DDR2 SDRAM supports concurrent auto precharge options, as shown in Table 4.

DDR2 SDRAM does not allow interrupting or truncating any WRITE burst using BL = 4 operation. Once the BL = 4 WRITE command is registered, it must be allowed to complete the entire WRITE burst cycle. However, a WRITE (with auto precharge disabled) using BL = 8 operation might be interrupted and truncated ONLY by another WRITE burst as long as the interruption occurs on a 4-bit boundary, due to the $4n$ prefetch architecture of DDR2 SDRAM. WRITE burst BL = 8 operations may not to be interrupted or truncated with any command except another WRITE command.

Data for any WRITE burst may be followed by a subsequent READ command. The number of clock cycles required to meet t_{WTR} is either 2 or t_{WTR}/t_{CK} , whichever is greater. Data for any WRITE burst may be followed by a subsequent PRECHARGE command. t_{WT} starts at the end of the data burst, regardless of the data mask condition.

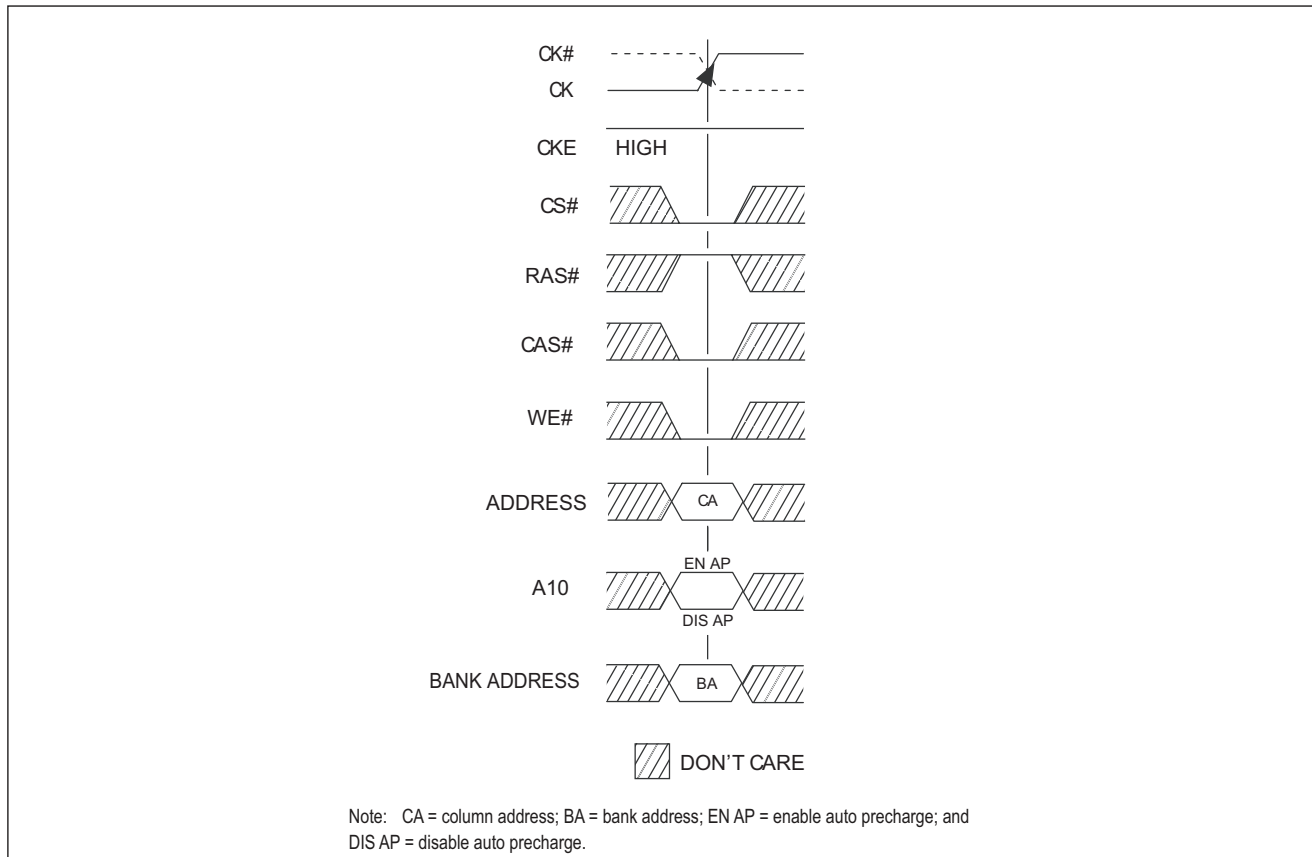
FIGURE 12 - WRITE COMMAND

TABLE 4 - WRITE USING CONCURRENT AUTO PRECHARGE

From Command (Bank <i>n</i>)	To Command (Bank <i>m</i>)	Minimum Delay (With Concurrent Auto Precharge)	Units
WRITE with Auto Precharge	READ OR READ w/ AP	$(CL-1) + (BL/2) + t_{WTR}$	t_{CK}
	WRITE OR WRITE w/ AP	$(BL/2)$	t_{CK}
	PRECHARGE or ACTIVE	1	t_{CK}

PRECHARGE COMMAND

The PRECHARGE command, illustrated in Figure 13, is used to deactivate the open row in a particular bank or the open row in all banks. The bank(s) will be available for a subsequent row activation a specified time (t_{RP}) after the PRECHARGE command is issued, except in the case of concurrent auto precharge, where a READ or WRITE command to a different bank is allowed as long as it does not interrupt the data transfer in the current bank and does not violate any other timing parameters. Once a bank has been precharged, it is in the idle state and must be activated prior to any READ or WRITE commands being issued to that bank. A PRECHARGE command is allowed if there is no open row in that bank (idle state) or if the previously open row is already in the process of precharging. However, the precharge period will be determined by the last PRECHARGE command issued to the bank.

PRECHARGE OPERATION

Input A10 determines whether one or all banks are to be precharged, and in the case where only one bank is to be precharged, inputs BA2–BA0 select the bank. Otherwise BA2–BA0 are treated as “Don’t Care.” When all banks are to be precharged, inputs BA2–BA0 are treated as “Don’t Care.”

Once a bank has been precharged, it is in the idle state and must be activated prior to any READ or WRITE commands being issued to that bank. t_{RPA} timing applies when the PRECHARGE (ALL) command is issued, regardless of the number of banks already open or closed. If a single-bank PRECHARGE command is issued, t_{RP} timing applies.

SELF REFRESH COMMAND

The SELF REFRESH command can be used to retain data in the DDR2 SDRAM, even if the rest of the system is powered down. When in the self refresh mode, the DDR2 SDRAM retains data without external clocking. All power supply inputs (including V_{REF}) must be maintained at valid levels upon entry/exit and during SELF REFRESH operation.

The SELF REFRESH command is initiated like a REFRESH command except CKE is LOW. The DLL is automatically disabled upon entering self refresh and is automatically enabled upon exiting self refresh (200 clock cycles must then occur before a READ command can be

FIGURE 13 – PRECHARGE COMMAND

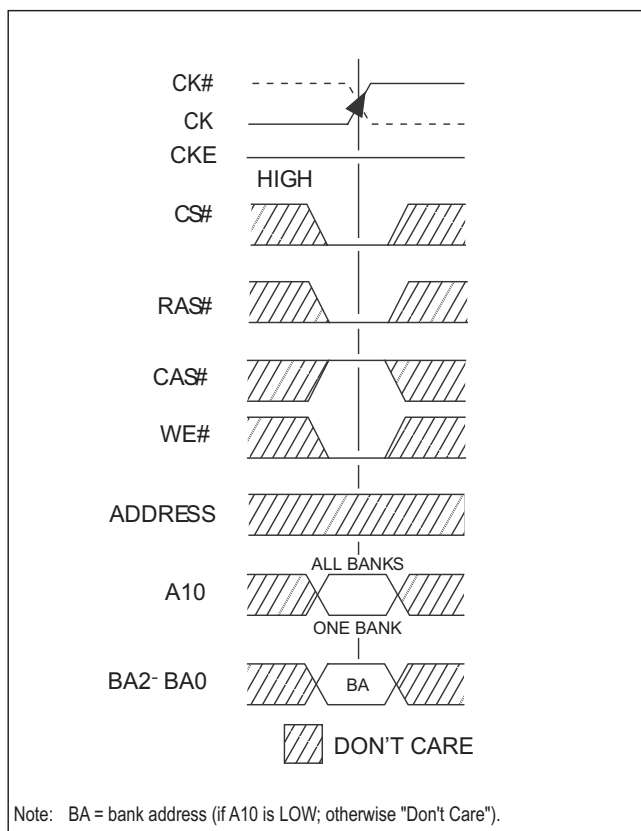

issued). The differential clock should remain stable and meet t_{CKE} specifications at least $1 \times t_{CK}$ after entering self refresh mode. All command and address input signals except CKE are “Don’t Care” during self refresh.

The procedure for exiting self refresh requires a sequence of commands. First, the differential clock must be stable and meet t_{CK} specifications at least $1 \times t_{CK}$ prior to CKE going back HIGH. Once CKE is HIGH ($t_{CLE(MIN)}$ has been satisfied with four clock registrations), the DDR2 SDRAM must have NOP or DESELECT commands issued for t_{XSNR} because time is required for the completion of any internal refresh in progress. A simple algorithm for meeting both refresh and DLL requirements is to apply NOP or DESELECT commands for 200 clock cycles before applying any other command.

Note: Self refresh not available at military temperature.

RESET FUNCTION

(CKE LOW Anytime)

DDR2 SDRAM applications may go into a reset state anytime during normal operation. If an application enters a reset condition, CKE is used to ensure the DDR2 SDRAM device resumes normal operation after reinitializing. All data will be lost during a reset condition; however, the DDR2 SDRAM device will continue to operate properly if the following conditions outlined in this section are satisfied.

The reset condition defined here assumes all supply voltages (V_{DD} , V_{DDQ} and V_{REF}) are stable and meet all DC specifications prior to, during, and after the RESET operation. All other input pins of the DDR2 SDRAM device are a “Don’t Care” during RESET with the exception of CKE.

If CKE asynchronously drops LOW during any valid operation (including a READ or WRITE burst), the memory controller must satisfy the timing parameter t_{DELAY} before turning off the clocks. Stable clocks must exist at the CK, CK# inputs of the DRAM before CKE is raised HIGH, at which time the normal initialization sequence must occur. The DDR2 SDRAM device is now ready for normal operation after the initialization sequence.

DC OPERATING CONDITIONS

 All Voltages referenced to V_{SS}

Parameter	Symbol	MIN	TYP	MAX	Units	Notes
Supply Voltage	V _{CC}	1.7	1.8	1.9	V	1
I/O Supply Voltage	V _{CCQ}	1.7	1.8	1.9	V	4
I/O Reference Voltage	V _{REF}	0.49 x V _{CCQ}	0.50 x V _{CCQ}	0.51 x V _{CCQ}	V	2
I/O Termination Voltage	V _{TT}	V _{REF} - 0.04	V _{REF}	V _{REF} + 0.04	V	3

- V_{CCQ} tracks V_{CC} due to direct tie in package.
- V_{REF} is expected to equal V_{CCQ}/2 of the transmitting device and to track variations in the DC level of the same. Peak-to-peak noise on V_{REF} may not exceed ± 1 percent of the DC value. Peak-to-peak AC noise on V_{REF} may not exceed ±2 percent of V_{REF}. This measurement is to be taken at the nearest V_{REF} bypass capacitor.
- V_{TT} is not applied directly to the device. V_{TT} is a system supply for signal termination resistors, is expected to be set equal to V_{REF} and must track variations in the DC level of V_{REF}.
- V_{CCQ} tracks with V_{CC} track with V_{CC}.

ABSOLUTE MAXIMUM RATINGS

Symbol	Parameter	Min	Max	Unit	
V _{CC}	Voltage on V _{CC} pin relative to V _{SS}	-1.0	2.3	V	
V _{CCQ}	Voltage on V _{CCQ} pin relative to V _{SS}	-0.5	2.3	V	
V _{IN} , V _{OUT}	Voltage on any pin relative to V _{SS}	-0.5	2.3	V	
T _{STG}	Storage Temperature	-55.0	125.0	°C	
T _{CASE}	Device Operating Temperature	-55.0	125.0	°C	
I _I	Input Leakage current; Any input 0V < V _{IN} < V _{CC} ; V _{REF} = .5XV _{CCQ} ; Other balls not under test = 0V	ADDR, BA _x	-8	8	uA
		RAS\, CAS\, WE\, CS\, CKE, DM, DQS, DQS\, RDQS	-5	5	uA
		CK, CK\	-5	5	uA
		DM	-5	5	uA
I _{OZ}	0V ≤ V _{OUT} ≤ V _{DDQ} , DQ & ODT Disabled	-5	5	uA	
I _{VREF}	V _{REF} Leakage Current	-10	10	uA	

INPUT / OUTPUT CAPACITANCE

 T_A = 25°C, f = 1 MHz, V_{CC} = V_{CCQ} = 1.8V

Parameter	Symbol	Max	Unit
Input capacitance (A0-A12, BA0-BA2, CS\, RAS\, CAS\, WE\, CKE, ODT)	C _{ADDR}	20	pF
Input capacitance CK, CK#	C _{IN2}	8	pF
Input capacitance DM, DQS, DQS#	C _{IN3}	10	pF
Input capacitance DQ0-71	C _{OUT}	12	pF

INPUT DC LOGIC LEVEL

All voltages referenced to Vss

Parameter	Symbol	Min	Max	Unit
Input High (Logic 1) Voltage	V_{IH} (DC)	$V_{REF} + 0.125$	$V_{CC} + 0.300^1$	V
Input Low (Logic 0) Voltage	V_{IL} (DC)	-0.300	$V_{REF} - 0.125$	V

Note 1: 300mV is allowed provided V_{CC} does not exceed 1.9V

INPUT AC LOGIC LEVEL

All voltages referenced to Vss

Parameter	Symbol	Min	Max	Unit
AC Input High (Logic 1) Voltage DDR2-400 & DDR2-533	V_{IH} (AC)	$V_{REF} + 0.250$	$V_{CC} + 0.300^1$	V
AC Input High (Logic 1) Voltage DDR2-667	V_{IH} (AC)	$V_{REF} + 0.200$	$V_{CC} + 0.300^1$	V
AC Input Low (Logic 0) Voltage DDR2-400 & DDR2-533	V_{IL} (AC)	-0.3	$V_{REF} - 0.250$	V
AC Input Low (Logic 0) Voltage DDR2-667	V_{IL} (AC)	-0.3	$V_{REF} - 0.200$	V

Note 1: 300mV is allowed provided V_{CC} does not exceed 1.9V



DDRII ICC SPECIFICATIONS AND CONDITIONS

Parameter		Symbol	667 MHZ -3	533 MHZ -38	400 MHZ -5	Units
Operating Current: One bank active-precharge						
tCL=tCK(ICC), tRC=tRC(ICC), tRAS=tRAS MIN(ICC); CKE is HIGH, CS\ is HIGH between valid commands; Address bus switching, Data bus switching		ICC0	525	480	440	mA
Operating Current: One bank active-READ-precharge current						
IOUT=0mA; BL=4, CL=CL(ICC), AL=0; tCK = tCK(ICC), tRC=tRC(ICC), tRAS=tRAS MIN(ICC), tRCD=tRCD(ICC); CKE is HIGH, CS\ is HIGH between valid commands; Address bus is switching; Data bus is switching		ICC1	600	520	480	mA
Precharge POWER-DOWN current						
All banks idle; tCK=tCK(ICC); CKE is LOW; Other control and address bus inputs are stable; Data bus inputs are floating		ICC2P	30	30	30	mA
Precharge quiet STANDBY current						
All banks idle; tCK=tCK(ICC); CKE is HIGH, CS\ is HIGH; Other control and address bus inputs are stable; Data bus inputs are floating		ICC2Q	250	210	160	mA
Precharge STANDBY current						
All banks idle; tCK=tCK(ICC); CKE is HIGH, CS\ is HIGH; Other control and address bus inputs are switching; Data bus inputs are switching		ICC2N	270	230	180	mA
Active POWER-DOWN current						
All banks open; tCK=tCK(ICC); CKE is LOW; Other control and address inputs are stable; Data bus inputs are floating	MRS[12]=0	ICC3P	125	105	95	mA
	MRS[12]=1		40	40	40	
Active STANDBY current						
All banks open; tCK=tCK(ICC), tRAS MAX(ICC), tRP=tRP(ICC); CKE is HIGH, CS\ is HIGH between valid commands; Other control and address bus inputs are switching; Data bus inputs are switching		ICC3N	240	200	165	mA
Operating Burst WRITE current						
All banks open, continuous burst writes; BL=4, CL=CL(ICC), tRP=tRP(ICC); CKE is HIGH, CS\ is HIGH betwn valid commands; Address bus inputs are switching; Data bus		ICC4W	685	565	485	mA
Operating Burst READ current						
All banks open, continuous burst READS, Iout=0mA; BL=4, CL=CL(ICC), AL=0; tCL=tCK(ICC), tRAS=tRAS MAX(ICC), tRP=tRP(ICC); CKE is HIGH, CS\ is HIGH betwn valid commands; Address and Data bus inputs switching		ICC4R	685	565	485	mA
Burst REFRESH current						
tCK=tCK(ICC); refresh command at every iRFC(ICC) interval; CKE is HIGH, CS\ is HIGH Between valid commands; Address bus inputs are switching; Data bus inputs are switching		ICC5	1000	880	800	mA
Self REFRESH current						
CK and CK\ at 0V; CKE <=0.2V; Other contro, address and data inputs are floating		ICC6	30	30	30	mA
Operating bank Interleave READ current:						
All bank interleaving READS, IOUT = 0mA; BL=4, CL=CL(ICC), AL=tRCD(ICC)-1xtCK(ICC); tCK=tCK(ICC), tRC=tRC(ICC), tRRD=tRRD(ICC); CKE is HIGH, CS\ is HIGH between valid commands; Address bus inputs are stable during deselects; Data bus inputs are switching		ICC7	1370	1280	1220	mA

AC OPERATING SPECIFICATIONS

Parameter	Symbol	-3 333MHz/667Mbps		-38 266MHz/533Mbps		-5 200MHz/400Mbps		Units	
		MIN	MAX	MIN	MAX	MIN	MAX		
Clock Cycle Time	CL=5	tCK _{AVG}	3	8				ns	
	CL=4	tCK _{AVG}	3.75	8	3.75	8	5	8	ns
	CL=3	tCK _{AVG}	5	8	5	8	5	8	ns
Clock High Time		tCH _{AVG}	0.48	0.52	0.48	0.52	0.48	0.52	tCK
Clock Low Time		tCL _{AVG}	0.48	0.52	0.48	0.52	0.48	0.52	tCK
Half Clock Period	Min of	tHP	tCH,tCL		tCH,tCL		tCH,tCL		ps
Clock Jitter - Period		tJIT _{PER}	-125	125	-125	125	-125	125	ps
Clock Jitter - Half Period		tJIT _{DUTY}	-125	125	-125	125	-150	150	ps
Clock Jitter - Cycle to Cycle		tJIT _{CC}	250		250		250		ps
Cumulative Jitter error, 2 Cycles		tERR _{2PER}	-175	175	-175	175	-175	175	ps
Cumulative Jitter error, 4 Cycles		tERR _{4PER}	-250	250	-250	250	-250	250	ps
Cumulative Jitter error, 6-10 Cycles		tERR _{10PER}	-350	350	-350	350	-350	350	ps
Cumulative Jitter error, 11-50 Cycles		tERR _{50PER}	-450	450	-450	450	-450	450	ps
DQ hold skew factor		tQHS	-	340	-	400	-	450	ps
DQ output access time from CK/CK\		tAC	-450	450	-500	500	-600	600	ps
Data-out High-Z window from CK/CK\		tHZ		tAC(MAX)		tAC(MAX)		tAC(MAX)	ps
DQS Low-Z window from CL/CK\		tLZ ₁	tAC(MIN)	tAC(MAX)	tAC(MIN)	tAC(MAX)	tAC(MIN)	tAC(MAX)	ps
DQ Low-Z window from CK/CK\		tLZ ₂	2*tAC(MIN)	tAC(MAX)	2*tAC(MIN)	tAC(MAX)	2*tAC(MIN)	tAC(MAX)	ps
DQ and DM input setup time relative to DQS		tDS _{JEDEC}	100		100		150		ps
DQ and DM input hold time relative to DQS		tDH _{JEDEC}	175		225		275		ps
DQ and DM input pulse width (for each input)		tDIPW	0.35		0.35		0.35		tCK
Data Hold skew factor		tQHS		340		400		450	ps
DQ-DQS Hold, DQS to first DQ to go non valid, per access		tQH	tHP-tQHS		tHP-tQHS		tHP-tQHS		ps
Data valid output window (DVW)		tDVW	tQH-tDQSQ		tQH-tDQSQ		tQH-tDQSQ		ps
DQS input-high pulse width		tDQSH	0.35		0.35		0.35		tCK
DQS input-low pulse width		tDQSL	0.35		0.35		0.35		tCK
DQS output access time from CK/CK\		tDQSCK	-400	400	-400	400	-450	450	ps
DQS falling edge to CK rising - setup time		tDSS	0.2		0.2		0.2		tCK
DQS falling edge from CK rising-hold time		tDSH	0.2		0.2		0.2		tCK
DQS-DQ skew, DQS to last DQ valid, per group, per access		tDQSQ		240		300		350	ps
DQS READ preamble		tRPRE	0.9	1.1	0.9	1.1	0.9	1.1	tCK
DQS READ postamble		tRPST	0.4	0.6	0.4	0.6	0.4	0.6	tCK
WRITE preamble setup time		tWPRES	0		0		0		ps
DQS WRITE preamble		tWPRE	0.35		0.35		0.35		tCK
DQS WRITE postamble		tWPST	0.4	0.6	0.4	0.6	0.4	0.6	tCK
Positive DQS latching edge to associated Clock edge		tDQSS	-0.25	0.25	-0.25	0.25	-0.25	0.25	tCK
WRITE command to first DQS latching transition			WL-tDQSS	WL+tDQSS	WL-tDQSS	WL+tDQSS	WL-tDQSS	WL+tDQSS	tCK



AC OPERATING SPECIFICATIONS (CONTINUED)

		-3 333MHz/667Mbps		-38 266MHz/567Mbps		-5 200MHz/400Mbps			
Parameter		Symbol	MIN	MAX	MIN	MAX	MIN	MAX	Units
COMMAND and ADDRESS	Address and Control input pulse width for each input	tIPW	0.6		0.6		0.6		tCK
	Address and Control input setup time	tIS _{JEDEC}	200		250		350		ps
	Address and Control input hold time	tIH _{JEDEC}	275		375		475		ps
	CAS\ to CAS\ command delay	tCCD	2		2		2		tCK
	ACTIVE to ACTIVE command (same bank)	tRC	55		55		55		ns
	ACTIVE bank a to ACTIVE bank b Command	tRRD	10		10		10		ns
	ACTIVE to READ or WRITE delay	tRCD	15		15		15		ns
	4-Bank activate period	tFAW	50		50		50		ns
	ACTIVE to PRECHARGE	tRAS	40	70000 ¹	40	70000 ¹	40	70000 ¹	ns
	Internal READ to PRECHARGE command delay	tRTP	7.5		7.5		7.5		ns
	WRITE recovery time	tWR	15		15		15		ns
	Auto PRECHARGE WRITE recovery+PRECHARGE time	tDAL	tWR + tRP		tWR + tRP		tWR + tRP		ns
	Internal WRITE to READ command delay	tWTR	7.5		7.5		10		ns
	PRECHARGE command period	tRP	15		15		15		ns
	PRECHARGE ALL command period	tRPA	tRP+tCL		tRP+tCL		tRP+tCL		ns
LOAD MODE, command Cycle time	tMRD	2		2		2		tCK	
REFRESH	CKE LOW to CK, CK\ uncertainty	tDELAY	tIS + tCL + tIH		tIS + tCL + tIH		tIS + tCL + tIH		ns
	REFRESH to ACTIVE or REFRESH to REFRESH command Interval	tRFC	127	70000 ¹	127	70000 ¹	127	70000 ¹	ns
	Average periodic REFRESH interval [Industrial temp]	tREFI _{IT}		7.8		7.8		7.8	us
	Average periodic REFRESH interval [Enhanced temp]	tREFI _{ET}		5.9		5.9		5.9	us
	Average periodic REFRESH interval [Military temp]	tREFI _{XT}		3.9		3.9		3.9	us
S. REFRESH	Exit SELF REFRESH to non READ command	tXSNR	tRFC(min) +10		tRFC(min) +10		tRFC(min) +10		ns
	Exit SELF REFRESH to READ command	tXSRD	200		200		200		tCK
	Exit SELF REFRESH timing reference	tISXR	tIS		tIS		tIS		ps
ODT	ODT turn-on delay	tAOND	2	2	2	2	2	2	tCK
	ODT turn-on delay	tAOND	tAC(min)	tAC(max)+ 700	tAC(min)	tAC(max)+ 1000	tAC(min)	tAC(max)+ 1000	ps
	ODT turn-off delay	tAOPD	2.5	2.5	2.5	2.5	2.5	2.5	tCK
	ODT turn-off delay	tAOF	tAC(min)	tAC(max)+ 600	tAC(min)	tAC(max)+ 600	tAC(min)	tAC(max)+ 600	ps
	ODT turn-on (power-down mode)	tAONPD	tAC(min) + 2000	2 x tCK + tAC(max)+ 1000	tAC(min) + 2000	2 x tCK + tAC(max)+ 1000	tAC(min) + 2000	2 x tCK + tAC(max)+ 1000	ps
	ODT turn-off (power-down mode)	tAOFPD	tAC(min) + 2000	2.5 x tCK + tAC(max)+ 1000	tAC(min) + 2000	2.5 x tCK + tAC(max)+ 1000	tAC(min) + 2000	2.5 x tCK + tAC(max)+ 1000	ps
	ODT to power-down entry latency	tANPD	3		3		3		tCK
	ODT power-down exit latency	tAXPD	8		8		8		tCK
	ODT enable from MRS command	tMOD	12		12		12		ns
PWRDN	Exit active POWER-DOWN to READ command, MR[12]=0	tXARD	2		2		2		tCK
	Exit active POWER-DOWN to READ command, MR[12]=1	tSARDS	7 - AL		6 - AL		6 - AL		tCK
	Exit PRECHARGE POWER-DOWN to any non READ	tXP	2		2		2		tCK
	CKE Min. HIGH/LOW time	tCLE	3		3		3		tCK

Note 1: Max value reduced to 10,000ns at 125°C



ORDERING INFORMATION

Part Number	Core Frequency	Data Rate	Device Grade	Availability
AS4DDR264M64PBG1-3/IT	333MHz	667Mbps	Industrial	Consult Factory
AS4DDR264M64PBG1-38/IT	266MHz	533Mbps	Industrial	Consult Factory
AS4DDR264M64PBG1-5/IT	200MHZ	400Mbps	Industrial	Consult Factory
AS4DDR264M64PBG1-3/ET	333MHz	667Mbps	Enhanced	Consult Factory
AS4DDR264M64PBG1-38/ET	266MHz	533Mbps	Enhanced	Consult Factory
AS4DDR264M64PBG1-5/ET	200MHZ	400Mbps	Enhanced	Consult Factory
AS4DDR264M64PBG1-3/XT	333MHz	667Mbps	Military	Consult Factory
AS4DDR264M64PBG1-38/XT	266MHz	533Mbps	Military	Consult Factory
AS4DDR264M64PBG1-5/XT	200MHZ	400Mbps	Military	Consult Factory
AS4DDR264M64PBG1R-3/IT	333MHz	667Mbps	Industrial - RoHS	Consult Factory
AS4DDR264M64PBG1R-38/IT	266MHz	533Mbps	Industrial - RoHS	Consult Factory
AS4DDR264M64PBG1R-5/IT	200MHZ	400Mbps	Industrial - RoHS	Consult Factory
AS4DDR264M64PBG1R-3/ET	333MHz	667Mbps	Enhanced - RoHS	Consult Factory
AS4DDR264M64PBG1R-38/ET	266MHz	533Mbps	Enhanced - RoHS	Consult Factory
AS4DDR264M64PBG1R-5/ET	200MHZ	400Mbps	Enhanced - RoHS	Consult Factory
AS4DDR264M64PBG1R-3/XT	333MHz	667Mbps	Military - RoHS	Consult Factory
AS4DDR264M64PBG1R-38/XT	266MHz	533Mbps	Military - RoHS	Consult Factory
AS4DDR264M64PBG1R-5/XT	200MHZ	400Mbps	Military - RoHS	Consult Factory

IT = Industrial = Industrial class integrated component, fully operable across -40C to +85C

ET = Enhanced = Enhanced class integrated component, fully operable across -40C to +105C

XT = Military = Mil-Temperature class integrated component, fully operable across -55C to +125C



DOCUMENT TITLE

4.2Gb, 64M x 64, DDR2 SDRAM, 16mm x 23mm - 208 PBGA Multi-Chip Package [iPEM]

REVISION HISTORY

<u>Rev #</u>	<u>History</u>	<u>Release Date</u>	<u>Status</u>
0.0	Initial Release	May 2008	Preliminary
0.5	Updated Pinout & Pin Description	June 2008	Preliminary
0.6	Change temp reference from Extended to Military	June 2009	Preliminary
0.7	Updated Micross information	January 2010	Preliminary