

REVISIONS					
#	LTR	DESCRIPTION	DATE	DMN	APPD
AF5		REVISED PER ECO-16-004800	12SEP2016	NK	MZ
AG		REVISED PER ECO-17-004657	05APR2017	RS	MZ
AH		REVISED PER ECO-19-014836	23OCT2019	RS	MZ
AJ		REVISED PER ECO-20-011431	28AUG2020	SG	MZ

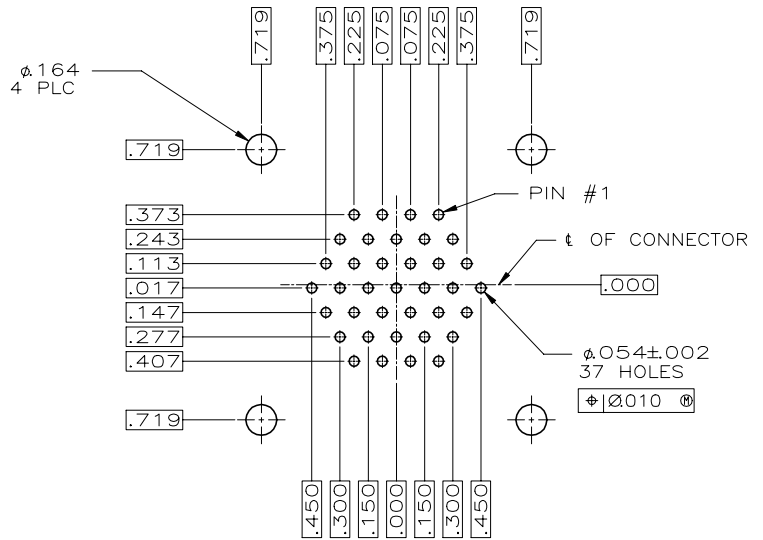
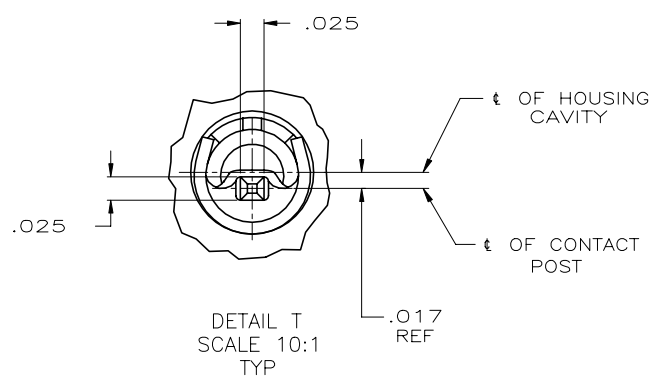
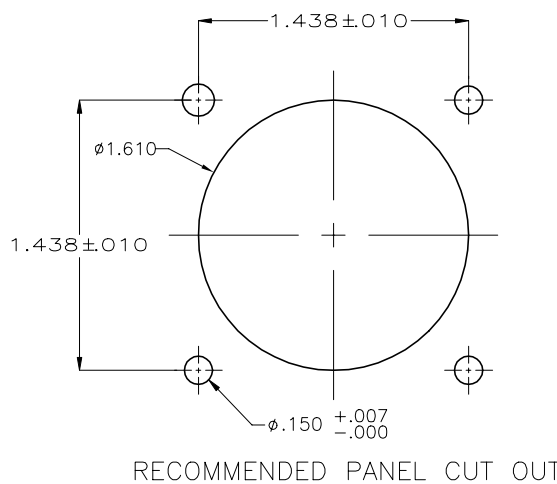
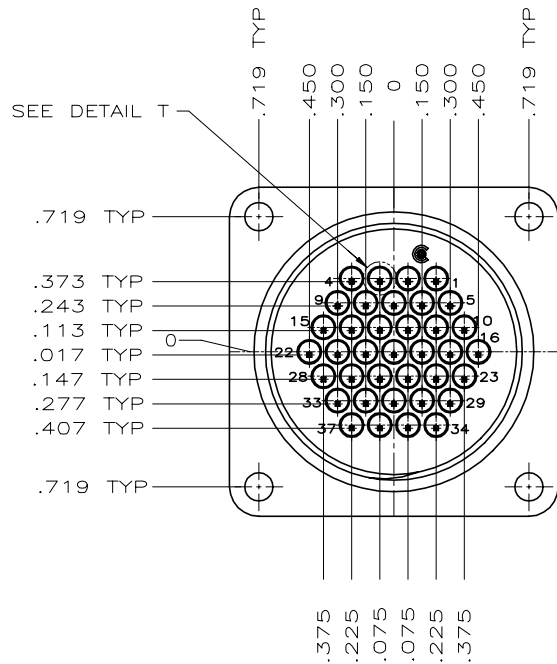
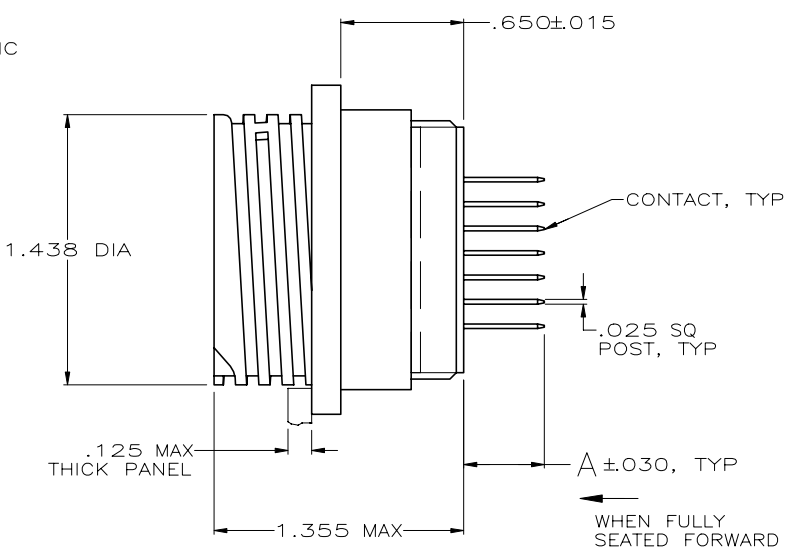
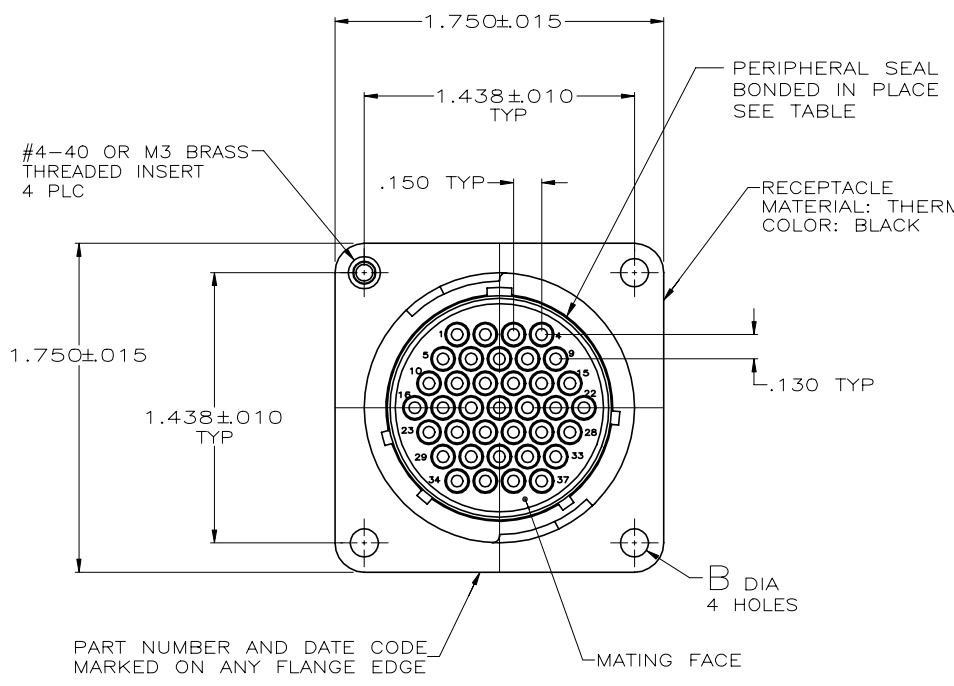

- CONNECTOR WILL ACCEPT POSTED TYPE III+ PIN CONTACTS.
- CONTACT BODY: SELECT GOLD OVER NICKEL.
CONTACT POST: TIN-LEAD PER MIL-T-10727 OVER COPPER PER MIL-C-14550A.
- RECOMMENDED PC BOARD HOLE SIZE FOR CONTACT POST: 1.02±0.08[.040±.003] DIA.
- CONTACT BODY: SELECT GOLD OVER NICKEL.
CONTACT POST: TIN OVER NICKEL.
- POSITIONS LOADED WITH CONTACTS: 1-4, 10-17, 19-22, 24, 25, 29, 30, 32, 33.
- POSITIONS LOADED WITH CONTACTS: 1-20, 22-28, 30-37.
- OBSOLETE PARTS: OBSOLETE CIS STREAMLINING PER D.RENAUD/D.SINISI.
- CONTACT BODY: TIN OVER NICKEL.
CONTACT POST: TIN OVER NICKEL.
- CONTACT BODY: SELECT GOLD OVER NICKEL.
CONTACT POST: TIN/LEAD OVER NICKEL.
- CONTACT BODY: TIN/LEAD OVER NICKEL.
CONTACT POST: TIN/LEAD OVER NICKEL.

REV	DESCRIPTION	DATE	DMN	APPD	REV	DESCRIPTION	DATE	DMN	APPD
5	NO	YES	NO	—	.220	3-206934-0			
4	OBSOLETE	NO	YES	YES	—	.170	2-206934-9		
3	OBSOLETE	NO	YES	NO	—	.413	2-206934-8		
2	PRELIMINARY	NO	YES	NO	—	.257	2-206934-7		
1	OBSOLETE	NO	YES	YES	—	.119	2-206934-6		
10	OBSOLETE	NO	NO	NO	.150±.003	.240	2-206934-5		
9	OBSOLETE	NO	NO	NO	.150±.003	.220	2-206934-3		
8	OBSOLETE	NO	NO	YES	.150±.003	.119	2-206934-2		
7	OBSOLETE	NO	YES	YES	—	.618	2-206934-0		
6	OBSOLETE	NO	NO	NO	.150±.003	.618	1-206934-9		
5	OBSOLETE	NO	NO	NO	.150±.003	.429	1-206934-8		
4	OBSOLETE	NO	YES	YES	—	.119	1-206934-7		
3	OBSOLETE	NO	NO	YES	.150±.003	.429	1-206934-5		
2	OBSOLETE	NO	YES	NO	—	.618	1-206934-4		
1	OBSOLETE	NO	YES	NO	—	.220	1-206934-3		
10	OBSOLETE	NO	NO	NO	.150±.003	.429	1-206934-2		
9	OBSOLETE	NO	NO	NO	.150±.003	.220	1-206934-1		
8	OBSOLETE	YES	NO	YES	—	.119	1-206934-0		
7	OBSOLETE	YES	YES	YES	—	.119	206934-9		
6	OBSOLETE	NO	NO	NO	.150±.003	.618	206934-7		
5	OBSOLETE	NO	NO	NO	.150±.003	.429	206934-6		
4	OBSOLETE	NO	NO	NO	.150±.003	.119	206934-5		
3	OBSOLETE	NO	YES	NO	—	.220	206934-4		
2	OBSOLETE	NO	NO	NO	.158±.001	.618	206934-3		
1	OBSOLETE	NO	NO	NO	.158±.001	.429	206934-2		
0	OBSOLETE	NO	NO	NO	.150±.003	.220	206934-1		

THIS DRAWING IS A CONTROLLED DOCUMENT.

DMN: J.GALLUCCI 5-30-91	CHK: W.G.LENKER 4-14-92	APPD: K.BEAVER 4-14-92	NAME: K.BEAVER
TE Connectivity			
RECEPTACLE ASSEMBLY, POSTED, STD SEX, SERIES 1, 23-37, CPC			
108-10024			
APPLICATION SPEC			
SIZE: A1	CAGE CODE: 00779	DRAWING NO: 206934	RESTRICTED TO: —
CUSTOMER DRAWING			

SCALE: 2:1 SHEET 1 OF 1 REV: AJ

Mouser Electronics

Authorized Distributor

Click to View Pricing, Inventory, Delivery & Lifecycle Information:

[TE Connectivity:](#)

[206934-1](#)