

DIAMOND

Fiber Optic Components

SPECIFICATIONS

STANDARD	Multimode	Single mode	Single mode 8° APC	Units	Test conditions
Insertion loss (IL)	typ 0.15 max 0.4	typ 0.2 max 0.4	typ 0.2 max 0.4	dB	IEC 61300-3-4; $\lambda = 1300/1550\text{nm}$
Return loss (RL)	min 35 typ 40	min 45 typ 50	min 70*	dB	IEC 61300-3-6; $\lambda = 1300/1550\text{nm}$
Repeatability of IL	max ± 0.1	max ± 0.1	max ± 0.1	dB	Over service life
Service life	1000 mate/demate cycles				
Operating temperature	-40 / +85			°C	Der Temperaturbereich des verwendeten Kabels kann die Steckerspezifikationen einschränken
Storage temperature	-40 / +90			°C	
Strain relief (cable)	> 100			N	

* Measured with high precision reflectometer

APPLICATIONS

Telecommunications, CATV, MAN, WAN, LAN, Test & Measurement, Industry, Medical, Sensors

STANDARDS

FC/PC: IEC 874-7, CECC 86 115-801
FC/APC: With all FC/APC connectors with key $\varnothing 2$ or 2.14 mm

DESIGN/MATERIALS

Fiber alignment: SM: Active Core Alignment via patented two-step crimping process
MM: Via patented crimping process

Polish: FC/PC: Convex (PC)
FC/APC: 8° angled convex (APC)

Ferrule: $\varnothing 2.5$ mm, zirconia ceramic with extending copper-nickel alloy insert (Pilzferrule), spring loaded (15 N), anti-rotation keyed

Adaptor: Floating zirconia resilient sleeve in Ni-plated brass housing

External parts: Ni-plated brass and Plastic black

Cable retention: Decoupled from ferrule on cable with $\varnothing \leq 3.5$ mm

AVAILABLE AS

- Underterminated connector
- Terminated patchcord or pigtail

FC

ALBERINO-CONNECTOR

HPC-S0.66 Alb SM
HPC-M0.66 Alb MM
HPC-S8.66 Alb SM/APC
HPC-S8.66/X Alb SM/APC



CONNECTORS

SINGLE MODE APC CONVEX, key $\varnothing 2$ mm

Type designation: HPC-S8.66/X Alb
Ferrule material: Zirconia/copper-nickel alloy insert (Pilzferrule)
External parts: Ni-plated brass / Plastic red
Polish geometry: 8° angled convex (APC)

Dimensions Fiber/Cable	Order Number	
	Underterminated connector	Terminated assembly
9/125/900	192 - 000 - 001 L 000	192 - xxx - 001 L xxx
9/125/900/2100	192 - 000 - 002 L 000	192 - xxx - 002 L xxx
9/125/900/2500	192 - 000 - 003 L 000	192 - xxx - 003 L xxx
9/125/900/3000	192 - 000 - 004 L 000	192 - xxx - 004 L xxx
9/125/900/3500	192 - 000 - 005 L 000	192 - xxx - 005 L xxx

Connectors for other fiber and cable dimensions available upon request

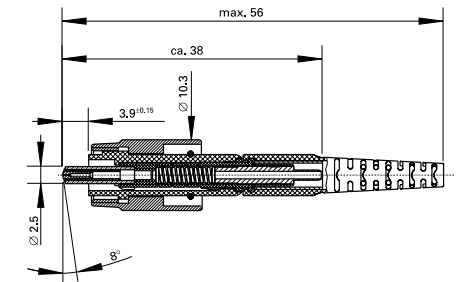

ADAPTORS

Type designation: MPC-S8.22/X

Mating sleeve	Material		Order Number
	External parts		
Zirconia	Ni-plated brass		110 - 301 - 904 V 002

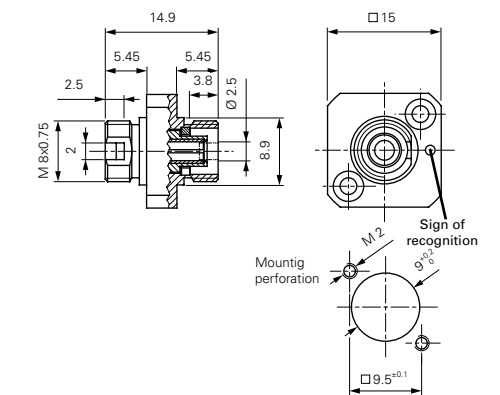

Type designation: MPC-S8.22/6 Kt. X

Mating sleeve	Material		Order Number
	External parts		
Zirconia	Ni-plated brass		110 - 301 - 911 V 002

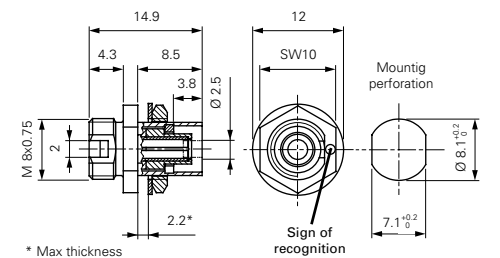

Type designation: MPC-S8.22/YX

Mating sleeve	Material		Order Number
	External parts		
Zirconia	Ni-plated brass		110 - 301 - 912 V 002

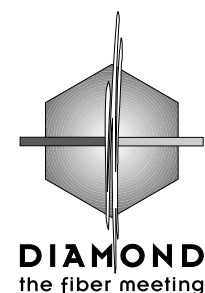
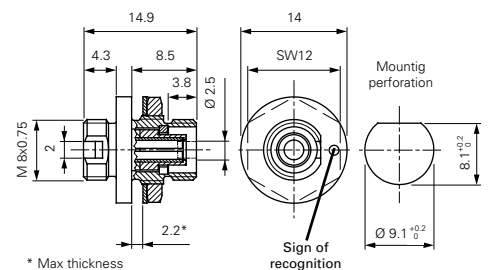

DIAMOND SA
Via dei Patrizi 5
CH-6616 LOSONE
Tel. ++41-91/785 45 45
Fax ++41-91/785 45 00
e-mail: info@diamond-fo.com

Specifications subject to change
without notice

002-037-202P007033

CONNECTORS

SINGLE MODE PC CONVEX, key \varnothing 2.14 mm

Type designation: **HPC-S0.66 Alb**
 Ferrule material: Zirconia/copper-nickel alloy insert (Pilzferrule)
 External parts: Ni-plated brass / Plastic black
 Polish geometry: Convex (PC)

Dimensions Fiber/Cable	Order Number	
	Unterminated connector	Terminated assembly
9/125/900	189 - 000 - 001 L 000	189 - xxx - 001 L xxx
9/125/900/2100	189 - 000 - 002 L 000	189 - xxx - 002 L xxx
9/125/900/2500	189 - 000 - 003 L 000	189 - xxx - 003 L xxx
9/125/900/3000	189 - 000 - 004 L 000	189 - xxx - 004 L xxx
9/125/900/3500	189 - 000 - 005 L 000	189 - xxx - 005 L xxx

Connectors for other fiber and cable dimensions available upon request

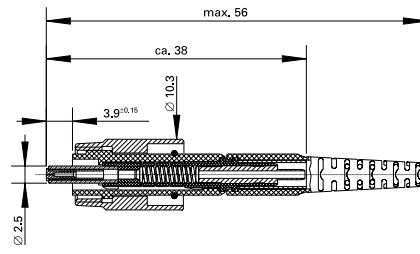

MULTIMODE PC CONVEX, key \varnothing 2.14 mm

Type designation: **HPC-M0.66 Alb**
 Ferrule material: Zirconia/copper-nickel alloy insert (Pilzferrule)
 External parts: Ni-plated brass / Plastic black
 Polish geometry: Convex (PC)

Dimensions Fiber/Cable	Order Number	
	Unterminated connector	Terminated assembly
50/125/900	190 - 000 - 001 L 000	190 - xxx - 001 L xxx
50/125/900/2100	190 - 000 - 002 L 000	190 - xxx - 002 L xxx
50/125/900/2500	190 - 000 - 003 L 000	190 - xxx - 003 L xxx
50/125/900/3000	190 - 000 - 004 L 000	190 - xxx - 004 L xxx
50/125/900/3500	190 - 000 - 005 L 000	190 - xxx - 005 L xxx

Connectors for other fiber and cable dimensions available upon request

ADAPTORS

Type designation: **MPC-S0.22**

Mating sleeve	Material		External parts	Order Number
	Zirconia	Ni-plated brass		
				110 - 301 - 907 V 001

Type designation: **MPC-M0.22**

Mating sleeve	Material		External parts	Order Number
	Zirconia	Ni-plated brass		
				110 - 301 - 919 V 001

Type designation: **MPC-S0.22/6 Kt.**

Mating sleeve	Material		External parts	Order Number
	Zirconia	Ni-plated brass		
				110 - 301 - 903 V 001

Type designation: **MPC-M0.22/6 Kt.**

Mating sleeve	Material		External parts	Order Number
	Zirconia	Ni-plated brass		
				110 - 301 - 920 V 001

Type designation: **MPC-S0.22/Y**

Mating sleeve	Material		External parts	Order Number
	Zirconia	Ni-plated brass		
				110 - 301 - 905 V 001

Type designation: **MPC-M0.22/Y**

Mating sleeve	Material		External parts	Order Number
	Zirconia	Ni-plated brass		
				110 - 301 - 921 V 001

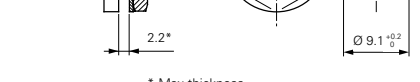
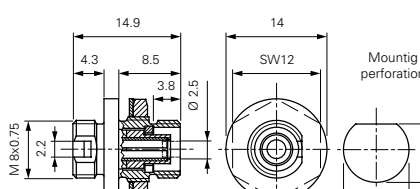
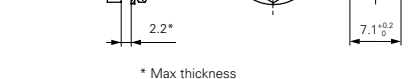
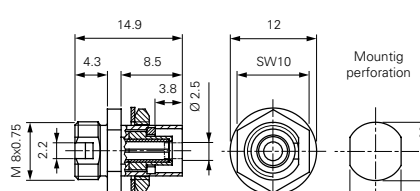
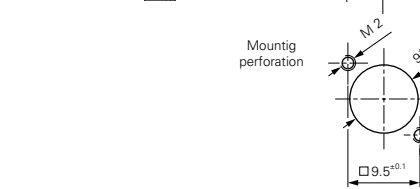
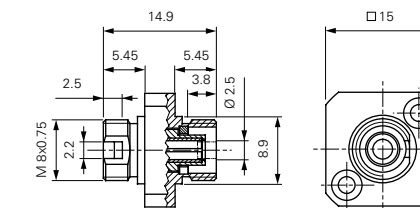

CONNECTORS

SINGLE MODE APC CONVEX, key \varnothing 2.14 mm

Type designation: **HPC-S8.66 Alb**
 Ferrule material: Zirconia/copper-nickel alloy insert (Pilzferrule)
 External parts: Ni-plated brass / Plastic black
 Polish geometry: 8° angled convex (APC)

Dimensions Fiber/Cable	Order Number	
	Unterminated connector	Terminated assembly
9/125/900	191 - 000 - 001 L 000	191 - xxx - 001 L xxx
9/125/900/2100	191 - 000 - 002 L 000	191 - xxx - 002 L xxx
9/125/900/2500	191 - 000 - 003 L 000	191 - xxx - 003 L xxx
9/125/900/3000	191 - 000 - 004 L 000	191 - xxx - 004 L xxx
9/125/900/3500	191 - 000 - 005 L 000	191 - xxx - 005 L xxx

Connectors for other fiber and cable dimensions available upon request

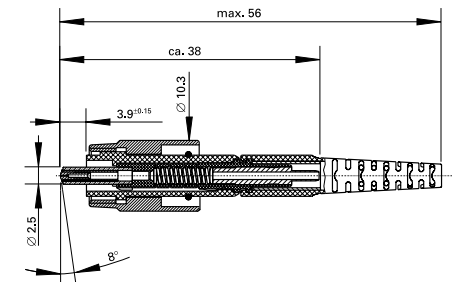

ADAPTORS

Type designation: **MPC-S8.22**

Mating sleeve	Material		External parts	Order Number
	Zirconia	Ni-plated brass		
				110 - 301 - 904 V 001

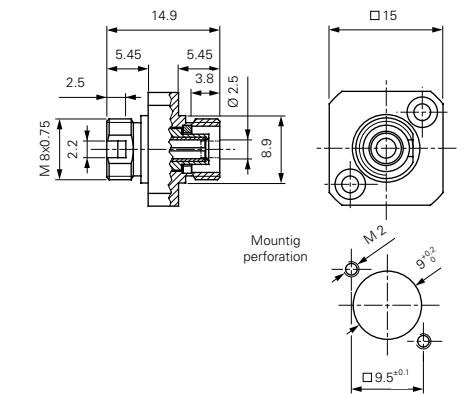

Type designation: **MPC-S8.22/6 Kt.**

Mating sleeve	Material		External parts	Order Number
	Zirconia	Ni-plated brass		
				110 - 301 - 903 V 002

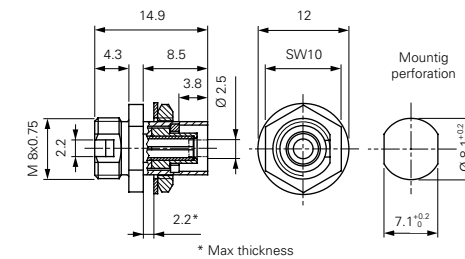

Type designation: **MPC-S8.22/Y**

Mating sleeve	Material		External parts	Order Number
	Zirconia	Ni-plated brass		
				110 - 301 - 905 V 002

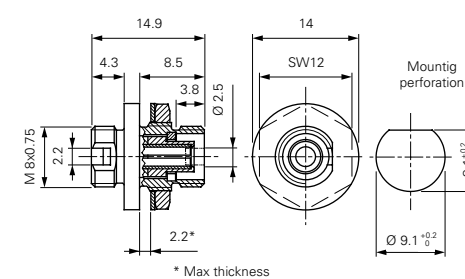

ORDER NUMBER CODES

- Connector code
- Connector code for termination on other end of assembly
 - For pigtails: insert 000
 - For patch assemblies: insert connector code for other connector
- Code for fiber or cable
- Length in meters

See ordering information for additional details