

Triple-Balanced Mixer

M50/M50C

V2

Features

- LO 2.0 TO 26.0 GHz
- RF 2.0 TO 26.0 GHz
- IF 1.0 TO 15.0 GHz
- LO DRIVE +10 dBm (nominal)
- HIGH COMPRESSION POINT
- VERY WIDE BANDWIDTH

Description

The M50 is a triple balanced mixer, designed for use in military, commercial and test equipment applications. The design utilizes Schottky ring quad diodes and broadband soft dielectric baluns to attain excellent performance. The use of high temperature solder and welded assembly processes used internally makes it ideal for use in manual, semi-automated assembly. Environmental screening available to MIL-STD-883, MIL-STD-202 or MIL-DTL-28837, consult factory.

Product Image

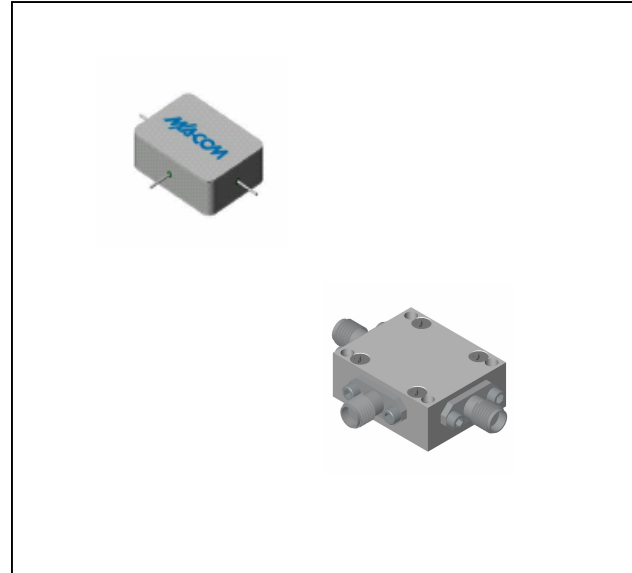

Ordering Information

Part Number	Package
M50	Minpac
M50C	SMA Connectorized

Electrical Specifications: $Z_0 = 50\Omega$ $L_o = +10$ dBm (Downconverter application only)

Parameter	Test Conditions	Units	Typical	Guaranteed	
				+25°C	-54° to +85°C *
SSB Conversion Loss (max) & SSB Noise Figure (max)	fR = 2.5 to 18 GHz, fL =2 to 18 GHz, fl =2 to 10 GHz	dB	7.5	9.5	10.0
	fR = 2 to 18 GHz, fL =2 to 26 GHz, fl =2 to 12 GHz	dB	8.0	10.5	11.0
	fR = 2 to 26 GHz, fL =2 to 26 GHz, fl =2 to 15 GHz	dB	9.0	11.5	12.0
Isolation, L to R (min)	fL = 2 to 3 GHz	dB	30	15	13
	fL = 3 to 26 GHz	dB	22	20	18
Isolation, L to I (min)	fL = 2 to 7 GHz	dB	30	15	13
	fL = 7 to 26 GHz	dB	22	20	20
1 dB Conversion Comp.	fL @ +10 dBm	dBm	+5		
Input IP3	fR1 =5 GHz @ -6 dBm, fR2 =5.01 GHz @ -6 dBm, fL=8 GHz @ 10 dBm	dBm	+15		
	fR1= 25 GHz @ -6 dBm, fR2 = 25.01 GHz @ -6 dBm, fL = 15 GHz @ 10 dBm	dBm	+15		

* The M50C specification limits apply at 0°C to +50°C.

Triple-Balanced Mixer

M50/M50C

V2

Typical Performance Curves

Conversion Loss vs. LO Drive Level

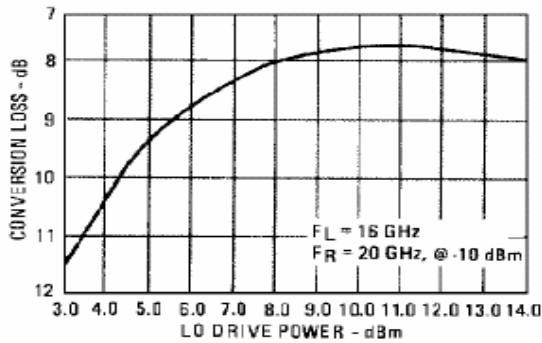

Isolation vs. Frequency

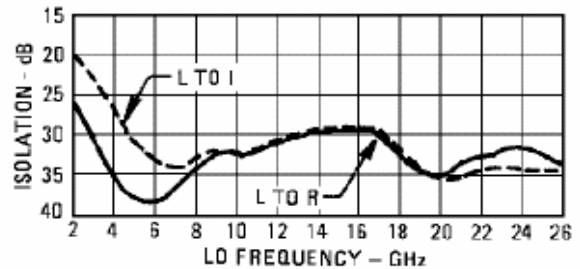

Conversion Loss vs. Frequency

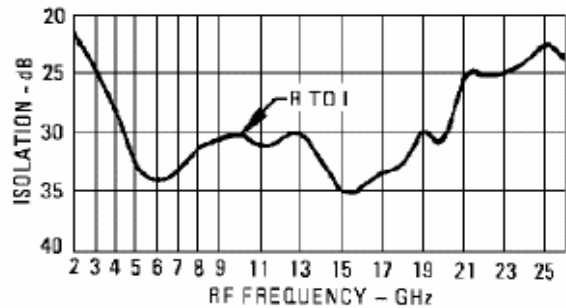
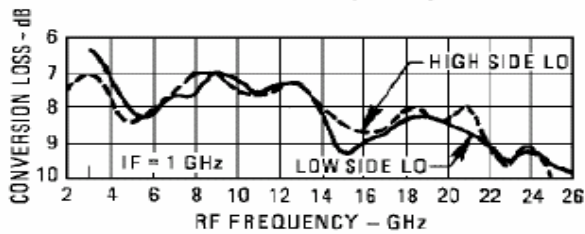

Conversion Loss vs. Frequency

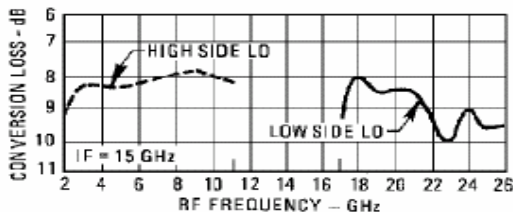
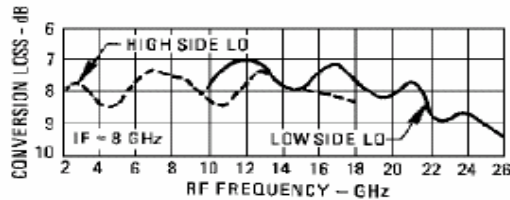

L-Port VSWR

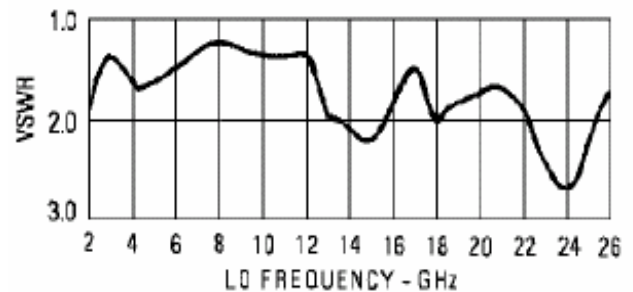

Triple-Balanced Mixer

M50/M50C

V2

Absolute Maximum Ratings

Parameter	Absolute Maximum
Operating Temperature	-54°C to +100°C
Storage Temperature	-65°C to +100°C
Peak Input Power	+26 dBm max @ +25°C +22 dBm max @ +100°C
Peak Input Current	mA DC

Outline Drawing: Minpac *

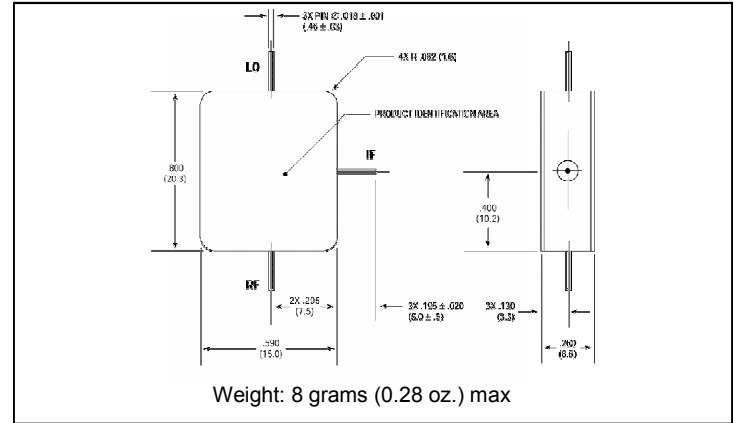

Outline Drawing: SMA Connectorized *

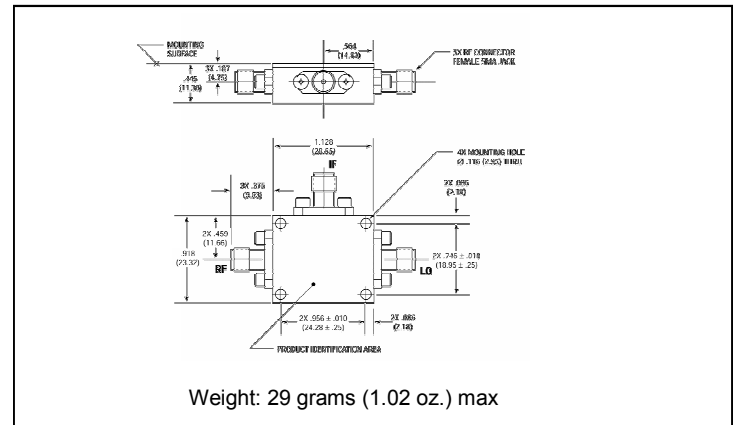

Dimensions are inches (millimeters) ±0.015 (0.38) unless otherwise specified.

I-Port VSWR

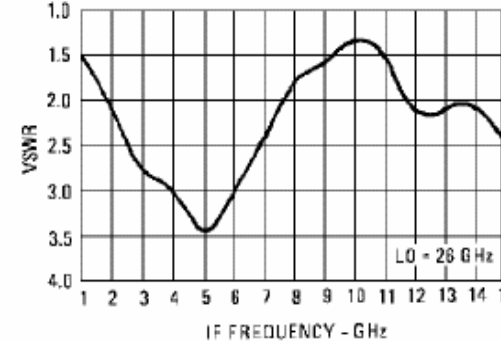
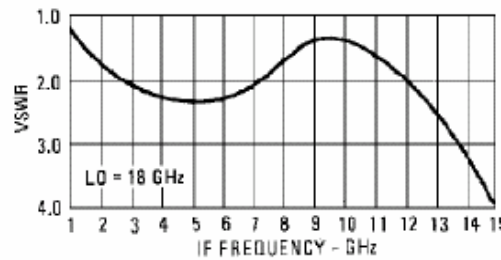
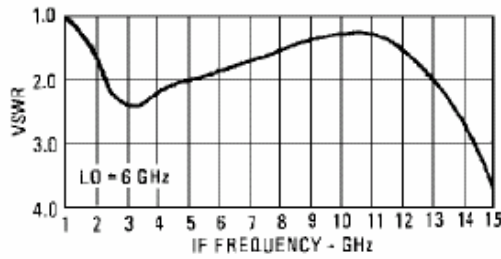
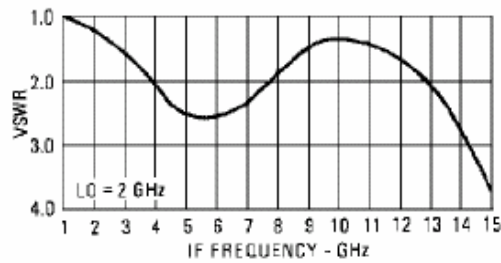

R-Port VSWR

