

# High Performance Power Entry Module with Fuses



- Rated currents up to 10 A
- Integrated dual fuse holder
- Optional reduced leakage current versions (A/B type)
- Complies with IEC/EN 60601-1
- Snap-in versions (S type)
- High attenuation performance



### Performance indicators

Attenuation performance

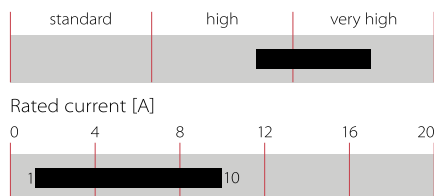

### Approvals & Compliances



The FN 9262 power entry module combines an IEC inlet, mains filter with very high filter attenuation based on nano crystalline material selection and fuses in a small form factor. Choosing FN 9262 product line brings you rapid availability of a standard filter associated with the necessary safety acceptances. Standard IEC connector filters are a practical solution helping you to pass EMI system approval in a short time. A wide selection on amperage ratings, mounting possibilities and filters for medical applications (acc. to IEC 60601-1 with low leakage current and high performance) are designed to offer you the desired solution.

### Features and Benefits

- Exceptional conducted attenuation performance, based on chokes with high saturation resistance and excellent thermal behavior
- FN 9262 B versions comply with the requirements of 1MOP acc. to IEC/EN 60601-1 for creepage and clearance, leakage current and high potential testing
- Versions up to 10 A are available with fuse holder for two fuses
- Custom-specific versions are available on request

### Technical specifications

<b>Operating voltage</b>	250 VAC, 50/60 Hz
<b>Operating frequency</b>	DC to 400 Hz
<b>Rated currents</b>	1 to 10 A @ 40°C max.
<b>High potential test voltage</b>	P → PE 2000 VAC for 2 sec (standard types) P → PE 2500 VAC for 2 sec (B types) P → N 760 VAC for 2 sec
<b>Protection category</b>	IP 40 according to IEC 60529
<b>Temperature range (operation and storage)</b>	-25°C to +85°C (25/85/21)
<b>Design corresponding to</b>	UL 60939-3, CSA Std C22.2 No. 8, IEC/EN 60939-3, GB/T 15287, GB/T 15288
<b>Flammability corresponding to</b>	Inlet plastic: UL 94 V-0 Fuseholder plastic: UL 94 V-0
<b>MTBF @ Rated amb. Temp./Voltage (Mil-HB-217F)</b>	2,100,000 hours
<b>Fuse holder</b>	2 fuses (Ø5 x 20 mm) (certified to IEC 60127-6)

### Typical applications

- Medical electrical devices (MD) and In-Vitro Diagnostic (IVD) medical devices
- Portable electrical and electronic equipment
- Small to medium-sized machines and household equipment
- Single-phase power supplies, switch-mode power supplies
- Test and measurement equipment

### Typical electrical schematic

FN 9262 (B types without Y-capacitors)

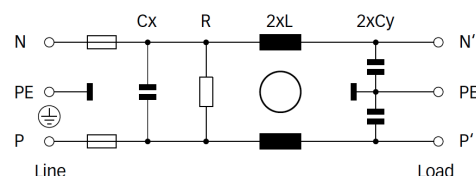

## Filter selection table

	Rated current @ 40°C [A]	Leakage current* @ 250 VAC/50 Hz (@ 120 VAC/60 Hz) [mA]	Inductance** L [mH]	Capacitance**		Resistor** R [kΩ]	Input/Output connections 	Fuses*** [Qty]	Weight [g]
				Cx [μF]	Cy [nF]				
<b>FN 9262-1-06</b>	1	0.31 (0.18)	40	0.22	2.2	1000	-06	2	55
<b>FN 9262-2-06</b>	2	0.31 (0.18)	20	0.22	2.2	1000	-06	2	55
<b>FN 9262-4-06</b>	4	0.31 (0.18)	7	0.22	2.2	1000	-06	2	55
<b>FN 9262-6-06</b>	6	0.31 (0.18)	3	0.22	2.2	1000	-06	2	55
<b>FN 9262-10-06</b>	10	0.31 (0.18)	1.15	0.22	2.2	1000	-06	2	55
<b>FN 9262A-1-06</b>	1	0.07 (0.04)	40	0.22	0.47	1000	-06	2	55
<b>FN 9262A-2-06</b>	2	0.07 (0.04)	20	0.22	0.47	1000	-06	2	55
<b>FN 9262A-4-06</b>	4	0.07 (0.04)	7	0.22	0.47	1000	-06	2	55
<b>FN 9262A-6-06</b>	6	0.07 (0.04)	3	0.22	0.47	1000	-06	2	55
<b>FN 9262A-10-06</b>	10	0.07 (0.04)	1.15	0.22	0.47	1000	-06	2	55
<b>FN 9262B-1-06</b>	1	0.00	40	0.22		1000	-06	2	55
<b>FN 9262B-2-06</b>	2	0.00	20	0.22		1000	-06	2	55
<b>FN 9262B-4-06</b>	4	0.00	7	0.22		1000	-06	2	55
<b>FN 9262B-6-06</b>	6	0.00	3	0.22		1000	-06	2	55
<b>FN9262B-10-06</b>	10	0.00	1.15	0.22		1000	-06	2	55

\* Leakage current under normal operating conditions (acc. to IEC60939-3). Note: if the neutral line is interrupted, worst case leakage could reach twice this level.

\*\* Tolerances apply: Inductance: -30/+50%, Capacitance: ±20%, Resistance: ±10%

\*\*\* Fuses are not included in the filter and need to be selected according to application

Product selector

FN 9262xx-yy-yy-y

Snap-in range for S version only

Blank: Snap-in range 0.6 to 1.5mm

20: Snap-in range 1.6 to 2.5mm

30: Snap-in range 2.6 to 3.5mm

06: Faston 6.3 x 0.8mm (spade/soldering)

1 to 10: Rated current

Blank: Standard version

A: Safety version

B: Medical version (without Y-capacitor)

Blank: Standard housing with mounting flanges

S: Snap-in version, snapper on vertical side

For example: FN 9262-1-06, FN 9262 SB-10-06

### Typical filter attenuation

Per CISPR 17; DM (differential mode)=50 Ω/50 Ω sym; CM (common mode)=50 Ω/50 Ω asym

FN 9262 Standard Type 1 A

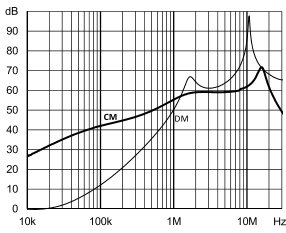

FN 9262 A Type 1 A

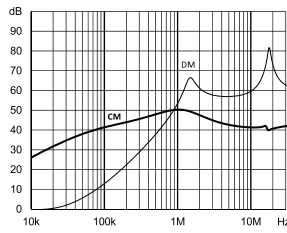

FN 9262 B Type 1 A

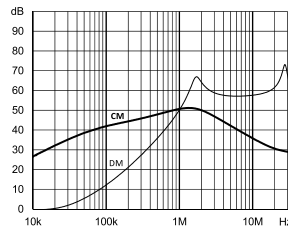

FN 9262 Standard Type 2 A

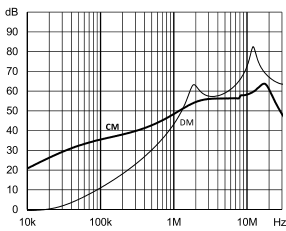

FN 9262 A Type 2 A

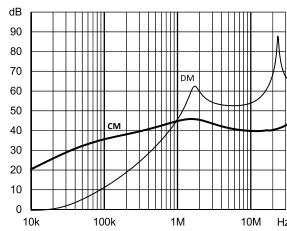

FN 9262 B Type 2 A

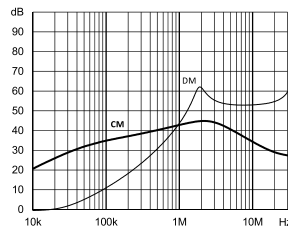

FN 9262 Standard Type 4 A

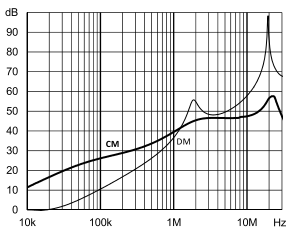

FN 9262 A Type 4 A

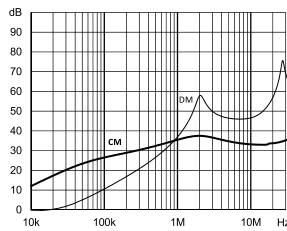

FN 9262 B Type 4 A

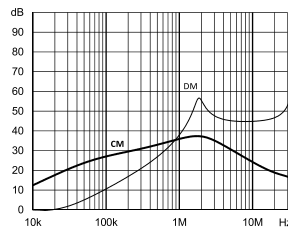

FN 9262 Standard Type 6 A

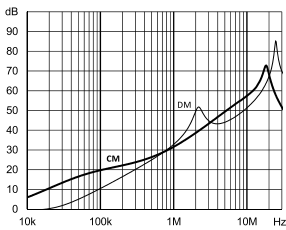

FN 9262 A Type 6 A

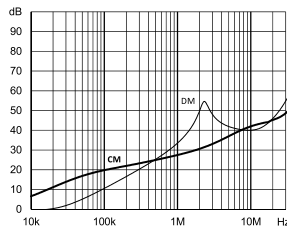

FN 9262 B Type 6 A

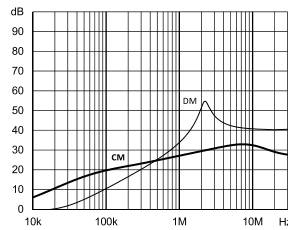

FN 9262 Standard Type 10 A

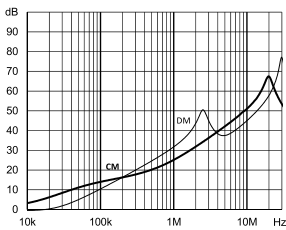

FN 9262 A Type 10 A

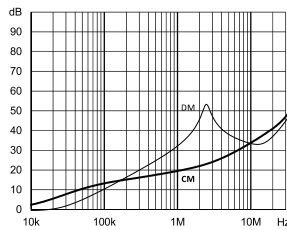

FN 9262 B Type 10 A

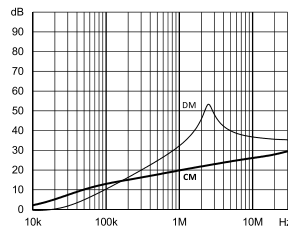

## Mechanical data

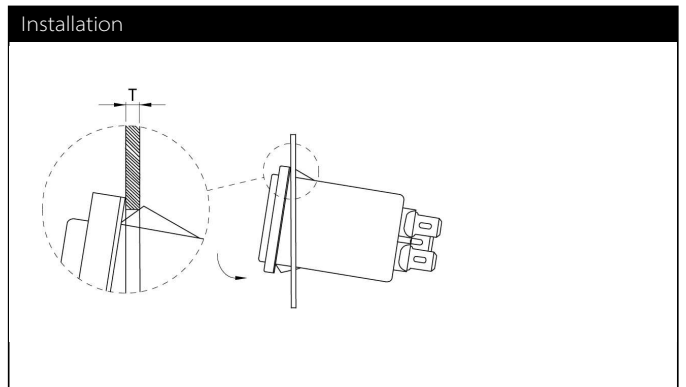
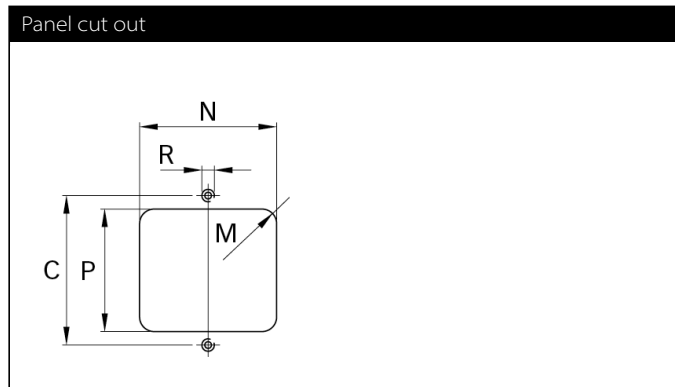
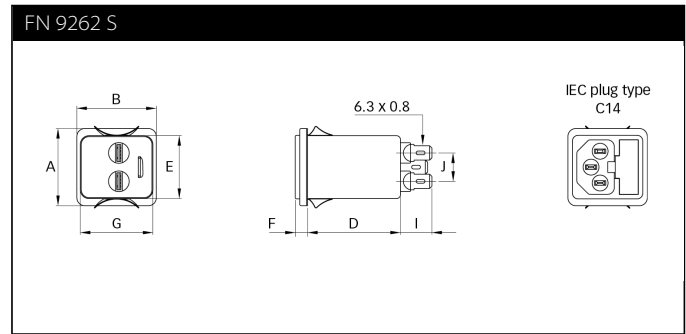
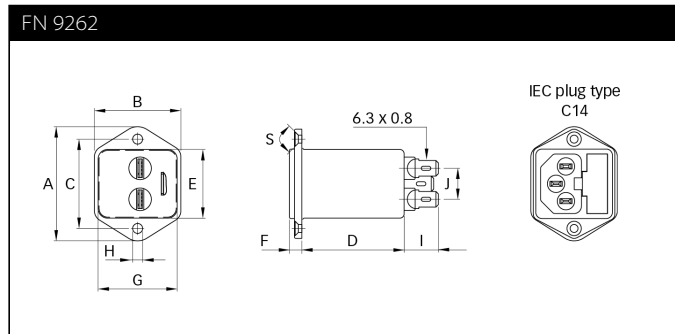

## Dimensions

	FN 9262	FN 9262 S	Tolerances
A	46	34	±0.3
B	35	35	±0.3
C	36		±0.3
D	41	41	±0.3
E	27.8	27.8	+0.3/-0
F	5.5	5.5	±0.3
G	32	32	+0.3/-0
H	Ø3.2		±0.1
I	14	14	±0.5
J	12.5	12.5	±0.3
M	R ≤ 3.5	R ≤ 3.5	
N	33 +0.3/-0	33 +0.2/-0	
P	29 ±0.3	29.5 ±0.2	
R*	M3		
S	90°		
T**		0.6-1.5	
T**		1.6-2.5	
T**		2.6-3.5	

\* Recommended torque for M3 (90° countersunk flat head) is 0.5 Nm

\*\* For selecting the panel thickness, please refer to the filter selector table.

All dimensions in mm; 1 inch = 25.4 mm  
Tolerances according to: ISO 2768-m/EN 22768-m

Please visit [www.schaffner.com](http://www.schaffner.com) to find more details on filter connections.

## Accessories

### Power Cord with angled Locking System C13



- | Locking system for standardized IEC C14 inlet filter
- | No accidental disconnection
- | Rated current up to 15 A
- | Fits any Schaffner IEC C14 inlet filter
- | Retrofit for any IEC C14 inlet
- | Various power line plugs for international usage

[Datasheet PDF >](#)

### IL 13P IEC C13 Rewireable Angled Connectors with Locking System



- | Locking system for standardized IEC C14 inlet filter
- | No accidental disconnection
- | Rated current up to 15 A
- | Fits any Schaffner IEC C14 inlet filter
- | Retrofit for any IEC C14 inlet
- | Various power line plugs for international usage

[Datasheet PDF >](#)

### IL 13P IEC C13 Rewireable Connectors with Locking System



- | Guards against accidental disconnection
- | Requires no other equipment or special inlets to secure it
- | Rewireable - offering total flexibility when assembling cables
- | Fits any Schaffner IEC C14 inlet Filter
- | Can be retrofitted
- | Various power line plugs for international usage
- | LSZH - Low smoke zero halogen

[Datasheet PDF >](#)



## Headquarters, global innovation and development

### Switzerland

#### Schaffner Group

Industrie Nord  
Nordstrasse 11e  
4542 Luterbach  
T +41 32 681 66 26  
[info@schaffner.com](mailto:info@schaffner.com)



## Sales and application centers

### China

#### Schaffner EMC Ltd. Shanghai

T20-3 C, No 565 Chuangye Road,  
Pudong district  
201201 Shanghai  
T +86 21 3813 9500  
[cschina@schaffner.com](mailto:cschina@schaffner.com)  
[www.schaffner.com.cn](http://www.schaffner.com.cn)

### Finland

#### Schaffner Oy

Sauvonrinne 19 H  
08500 Lohja  
T +358 50 468 7284  
[finlandsales@schaffner.com](mailto:finlandsales@schaffner.com)

### France

#### Schaffner EMC S.A.S.

16-20 Rue Louis Rameau  
95875 Bezons  
T +33 1 34 34 30 60  
F +33 1 39 47 02 28  
[francesales@schaffner.com](mailto:francesales@schaffner.com)

### Germany

#### Schaffner Deutschland GmbH

Schoemperlenstrasse 12B  
76185 Karlsruhe  
T +49 721 56910  
F +49 721 569110  
[germanysales@schaffner.com](mailto:germanysales@schaffner.com)

### India

#### Schaffner India Pvt. Ltd

REGUS WORLD TRADE CENTRE  
WTC, 22nd Floor Unit No 2238, Brigade  
Gateway Campus, 26/1, Dr. Rajkumar Road  
Malleshwaram (W)  
560055 Bangalore  
T +91 80 67935355  
[indiasales@schaffner.com](mailto:indiasales@schaffner.com)

### Italy

#### Schaffner EMC S.r.l.

Via Ticino, 30  
20900 Monza (MB)  
T +39 039 21 41 070  
[italysales@schaffner.com](mailto:italysales@schaffner.com)

### Japan

#### Schaffner EMC K.K.

Taiju-Seimei Sangenjaya Bldg.  
1-32-12, Kamiyuma, Setagaya-ku  
154-0011 Tokyo  
T +81 3 5712 3650  
F +81 3 5712 3651  
[japansales@schaffner.com](mailto:japansales@schaffner.com)  
[www.schaffner.jp](http://www.schaffner.jp)

### Singapore

#### Schaffner EMC Pte Ltd.

#05-09, Kg Ubi Ind. Estate  
408705 Singapore  
T +65 6377 3283  
F +65 6377 3281  
[singaporesales@schaffner.com](mailto:singaporesales@schaffner.com)

### Spain

#### Schaffner EMC España

Calle Caléndula 93, Miniparc III, Edificio E  
El Soto de Moraleja, Alcobendas  
28109 Madrid  
T +34 917 912 900  
F +34 917 912 901  
[spainsales@schaffner.com](mailto:spainsales@schaffner.com)

### Sweden

#### Schaffner EMC AB

Östermalmstorg 1  
114 42 Stockholm  
T +46 8 5050 2425  
[swedensales@schaffner.com](mailto:swedensales@schaffner.com)  
[www.schaffner.com](http://www.schaffner.com)

### Switzerland

#### Schaffner EMV AG

Industrie Nord  
Nordstrasse 11e  
4542 Luterbach  
T +41 32 681 66 88  
T +41 32 681 66 26  
[switzerlandsales@schaffner.com](mailto:switzerlandsales@schaffner.com)

### Taiwan

#### Schaffner EMV Ltd.

20 Floor-2, No 97, Section 1, XinTai 5th Road  
22175 XiZhi District New Taipei City 22175  
T +886 2 2697 5500  
F +886 2 2697 5533  
[taiwansales@schaffner.com](mailto:taiwansales@schaffner.com)  
[www.schaffner.com.tw](http://www.schaffner.com.tw)

### Thailand

#### Schaffner EMC Co. Ltd.

Northern Region Industrial Estate  
67 Moo 4 Tambon Ban Klang  
Amphur Muangng P.O. Box 14  
51000 Lamphun  
T +66 53 58 11 04  
F +66 53 58 10 19  
[thailandsales@schaffner.com](mailto:thailandsales@schaffner.com)

### United Kingdom

#### Schaffner Ltd.

1, Oakmede Place  
Binfield  
RG42 4JF Berkshire  
T +44 118 9770070  
F +44 118 9792969  
[uksales@schaffner.com](mailto:uksales@schaffner.com)

### USA

#### Schaffner EMC Inc.

52 Mayfield Avenue  
Edison, New Jersey  
T +1 732 225 9533  
F +1 732 225 4789  
[usasales@schaffner.com](mailto:usasales@schaffner.com)  
[www.schaffnerusa.com](http://www.schaffnerusa.com)

To find your local partner within Schaffner's global network: [www.schaffner.com](http://www.schaffner.com)

© 2020 Schaffner Group

The content of this document has been carefully checked and understood. However, neither Schaffner nor its subsidiaries assume any liability whatsoever for any errors or inaccuracies of this document and the consequences thereof. Published specifications are subject to change without notice. Product suitability for any area of application must ultimately be determined by the customer. In all cases, products must never be operated outside their published specifications. Schaffner does not guarantee the availability of all published products. This disclaimer shall be governed by substantive Swiss law and resulting disputes shall be settled by the courts at the place of business of Schaffner Holding AG. Latest publications and a complete disclaimer can be downloaded from the Schaffner website. All trademarks recognized.