

59170 Series

Sub-miniature Overmolded Reed Switch

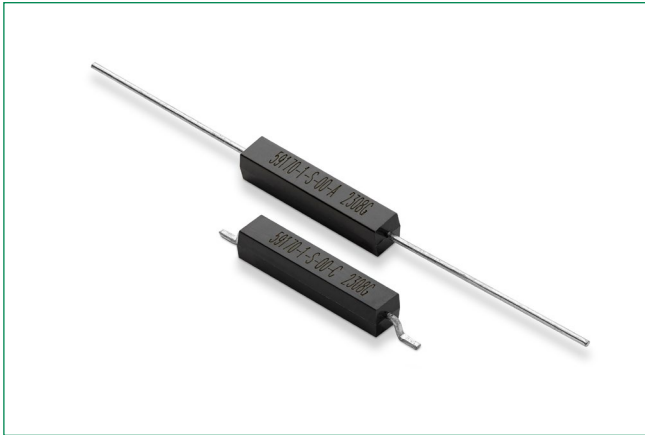

Description

The 59170 is a sub-miniature overmolded reed switch 11.43mm x 2.29mm x 2.29mm (0.450" x 0.090" x 0.090") with either straight or Gull Wing leads. It has normally open contact and capable of switching up to 200Vdc at 10W.

Note: The 57045 Actuator is sold separately.

Features & Benefits

- Two-part magnetically operated proximity switch
- Gull Wing, leaded
- Tape and reel option
- Solder reflow capable
- Thermoset overmolded material
- RoHS compliant
- Certified for use in North American Hazardous Locations: Class I, Division 2 and Zone 2
- ATEX certified for use in European explosive atmospheres: Ex II 3 G Ex nC IIC Gc
- Suitable for pick and place
- No standby power requirement
- Operates through non-ferrous materials such as wood, plastic or aluminium
- Hermetically sealed, magnetically operated contacts continue to operate long after optical and other technologies fail due to contamination

Additional Information



Resources



Accessories



Samples

Agency Approvals

Agency	Agency File Number
	E61760
	E471070
	DEMKO 14 ATEX 1393U
	Ex II 3 G Ex nC IIC Gc

Note: Contact Littelfuse for specific agency approval ratings.

Applications

- Position and Limit Sensing
- Security System Switch
- Door and Window Proximity Sensing
- Metering
- Automotive Electronics
- Anti-Tamper Detection
- Small Appliances

Dimensions

Dimensions in mm (inch)

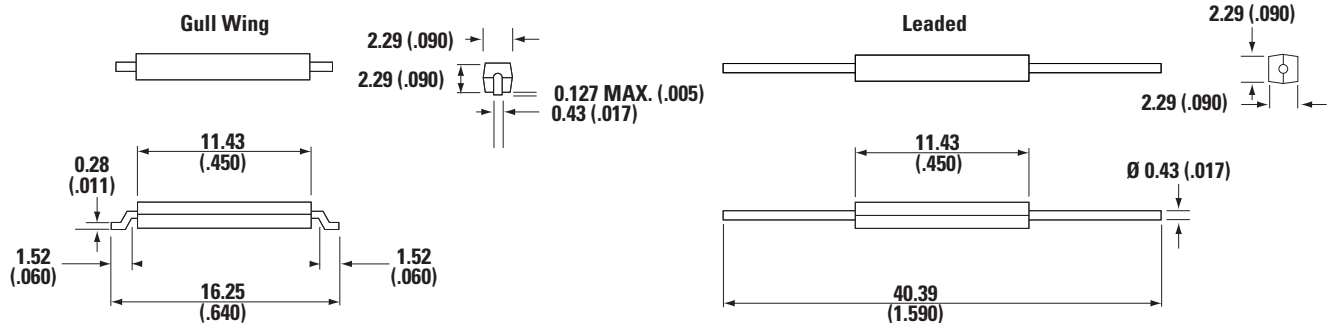

Soldering Footprint

Dimensions in mm (inch)

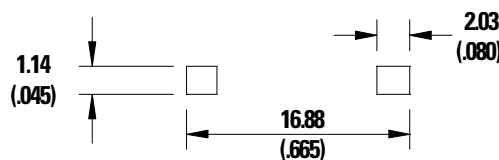

59170 Series

Sub-miniature Overmolded Reed Switch

Electrical Ratings

Contact Type			Normally Open
Switch Type			1
Contact Rating ¹		VA/Watt - max.	10
Voltage ³	Switching ²	Vdc - max.	200
	Breakdown ⁴	Vac - max.	140
		Vdc - min.	250
Current ³	Switching ²	Adc - max.	0.5
	Carry	Aac - max.	0.35
		Adc - max.	1A
Resistance	Contact, Initial	Ω - max.	0.120 Ohm
	Insulation	Ω - min.	10 ¹²
Capacitance	Contact	pF - typ.	0.2
Temperature	Operating	°C	-40 to +125

Product Characteristics			
Operate Time ⁵		ms - max.	0.5
Release Time ⁵		ms - max.	0.1
Shock ⁶	11ms ½ sine	G - max.	100
Vibration ⁶	50-2000 Hz	G - max.	30

Notes:

- Contact rating - Product of the switching voltage and current should never exceed the wattage rating. Contact Littelfuse for additional load/life information.
- When switching inductive and/or capacitive loads, the effects of transient voltages and/or currents should be considered. Refer to Application Notes AN108A and AN107 for details.
- Electrical Load Life Expectancy - Contact Littelfuse with voltage, current values along with type of load.
- Breakdown Voltage - per MIL-STD-202, Method 301.
- Operate (including bounce)/Release Time - per EIA/NARM RS-421-A, diode suppressed coil (Coil III).
- Shock and Vibration - per EIA/NARM RS-421-A and MIL-STD-202.

Sensitivity Options (Using 57045 Actuator)

Select Option	S		T		U		V	
Switch Type	Pull-In AT Range	Activate Distance, D mm (inch) Average	Pull-In AT Range	Activate Distance, D mm (inch) Average	Pull-In AT Range	Activate Distance, D mm (inch) Average	Pull-In AT Range	Activate Distance, D mm (inch) Average
1 Normally Open	10-15	6.5 (.255)	15-20	5.0 (.197)	20-25	4.6 (.181)	25-30	4.5 (.177)

Note:

- Pull-In AT Range: These AT values are the before molding and modification AT of the 59170.
- The activation distance is average value post modification for the Gull wing option C or D.

Termination Specification

Termination Options	
Select Option	Description
A	Leaded
C	Gull Wing bulk packed
D	Gull Wing tape and reel

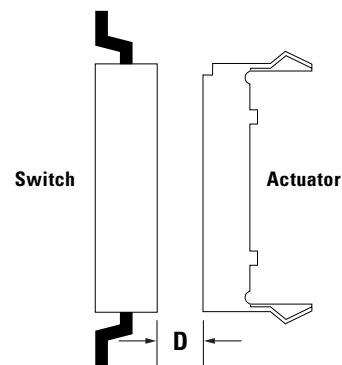

59170 Series

Sub-miniature Overmolded Reed Switch

Part Numbering System

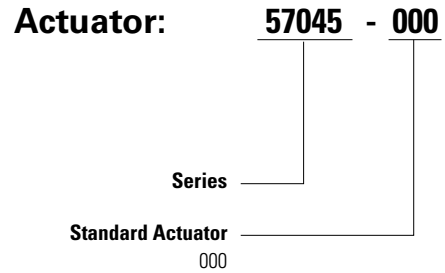
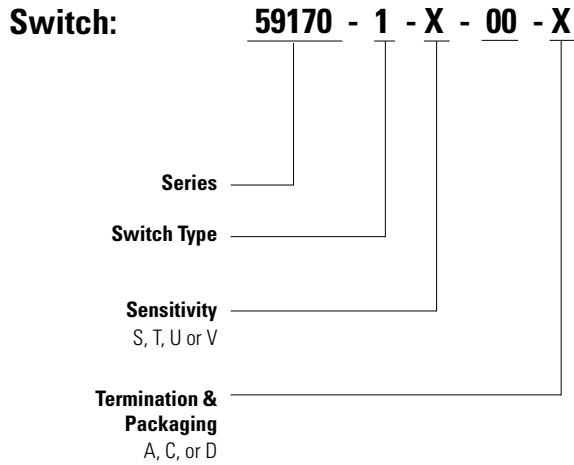

Note: The 57045 Actuator is sold separately.

Product Marking

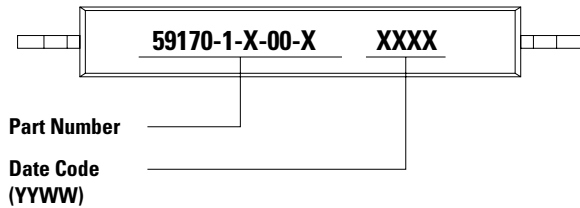

Packaging

Packaging Option	Packaging Specification	Quantity	Termination and Packaging Code	Taping Width
Bulk	Bulk	59170-1-X-00-A 800/box	A	N/A
Bulk	Bulk	59170-1-X-00-C 1500/box	C	N/A
Tape and Reel	EIA-RS-481-1	1500	D	32.00mm (1.260")

Disclaimer Notice - Information furnished is believed to be accurate and reliable. However, users should independently evaluate the suitability of and test each product selected for their own applications. Littelfuse products are not designed for, and may not be used in, all applications. Read complete Disclaimer Notice at: www.littelfuse.com/disclaimer-electronics.