

**SANYO**

No. 4387

**STK301-060****7-band, 2-channel Electronic Graphic Equalizer****Overview**

The STK301-060 is a hybrid IC (HIC) for electronically controlled graphic equalizer applications and is equipped with on-chip electronic volume for 7-band, 2-channel graphic equalization thereby permitting one-touch up-down control of all band gains. The STK301-060 is a hybrid IC which combines SC system and photoresist techniques with folded board construction while incorporating Sanyo's unique insulated metal substrate technology (IMST) to the base.

**Applications**

- Car stereos
- Portable radio-cassette players
- Home stereos

**Features**

- All bands are set for L/R simultaneous 2 dB incremental operation (typ).
- All bands are equipped with 13 positions and range between +12 dB maximum boost to -12 dB maximum cut.
- Crossover frequencies include  $f_0$ ; 60 Hz, 150 Hz, 400 Hz, 1 kHz, 2.5 kHz, 6 kHz and 15 kHz.
- The following features can be made available with an electronic graphic equalizer system which incorporates the 3-IC construction consisting of the STK301-060, a controller (LC7060 or universal microcontroller such as LC6502) along with the display LSI (LC7560→LCD, LC7565→FLT, LED):
  - 1) One-touch up-down control of all band gains.
  - 2) Immediate recall of preferred frequency levels tailored to suit musical selections. This is possible using preset functions to retrieving items from one-touch memory.
  - 3) Such functions as setting all bands to 0 dB (flat function), or switching frequency characteristics from 0 dB to center (reverse function) may be simply performed with supported software.
  - 4) Dual control lines permit mutual use with display LSI and help to simplify wiring between microcontroller and LSI.

**Specifications****Absolute Maximum Ratings at  $T_a = 25^\circ\text{C}$ ,  $V_{SS} = 0\text{V}$** 

			unit
Maximum supply voltage	$V_{DD}$ - $V_{EE}$ max	16	V
	$V_{CC1}$ max	36 ( $\pm 18$ )	V
	$V_{CC2}$ max	7	V
Input voltage	$V_{i1}$	CLK, DI, IN1, IN2	0 to $V_{CC2} + 0.3$
	$V_{i2}$	CLK, DI, IN1, IN2	$V_{EE} - 0.3$ to $V_{DD} + 0.3$
Allowable power dissipation	$P_d$ max	920	mW
Operating temperature	$T_{opg}$	-20 to +70	$^\circ\text{C}$
Storage temperature	$T_{stg}$	-40 to +100	$^\circ\text{C}$

Specifications and information herein are subject to change without notice.

**SANYO Electric Co., Ltd. Semiconductor Business Headquarters**

TOKYO OFFICE: Tokyo Bldg., 1-10, 1-Chome, Ueno, Taito-ku, TOKYO, 110 JAPAN

**Package Dimensions**

unit : mm

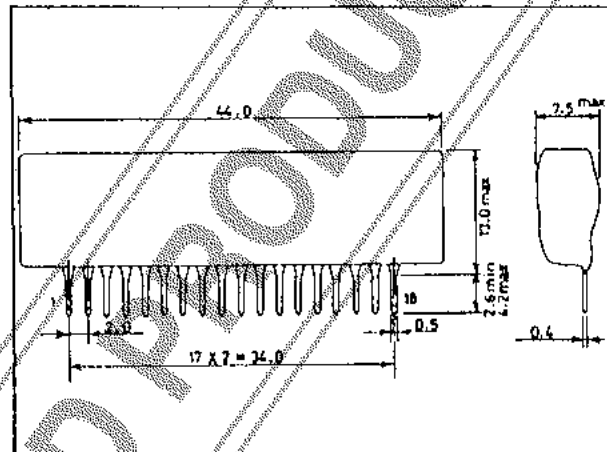
**4133**

**Recommended Operational Voltage at Ta = 25 °C, VSS = 0 V**

Supply voltage	V <sub>DD</sub> /V <sub>EE</sub>	±7 (14)	V
	V <sub>CC1</sub>	±7 (14)	V
	V <sub>CC2</sub>	5	V

**Allowable Operating Range at Ta = 25°C, VSS = 0V**

Supply voltage	V <sub>DD</sub> -V <sub>EE</sub>	7.5 to 15.0	V
	V <sub>CC1</sub>	±4 to ±18 (8 to 36)	V
	V <sub>CC2</sub>	4.5 to 5.5	V
Input "H" Level voltage	V <sub>IH</sub>	0.8V <sub>CC2</sub> to V <sub>CC2</sub>	V
Input "L" Level voltage	V <sub>IL</sub>	0.2V <sub>CC2</sub>	V
Input pulse width	t <sub>pw</sub>	from 1	µs
Setup time	t <sub>setup</sub>	from 1	µs
Hold time	t <sub>hold</sub>	from 1	µs
Operating frequency	f <sub>opg</sub>	up to 330	kHz

**Operating Characteristics**

at Ta = 25°C, VSS = 0V, V<sub>DD</sub>/V<sub>EE</sub> = ±7V, V<sub>CC1</sub> = ±7V, V<sub>CC2</sub> = 5V, f = 1kHz

All bands flat, via specified Test Circuit

		min	typ	max	unit	
Current consumption	I <sub>DD</sub>			1	mA	
	I <sub>CC1</sub>	V <sub>CC1</sub> = ±7V, V <sub>DD</sub> /V <sub>EE</sub> = ±7V, V <sub>SS</sub> = 0V	20	30	mA	
	I <sub>CC2</sub>	V <sub>CC2</sub> = 5V		1	mA	
Voltage gain	V <sub>G</sub>	V <sub>IN</sub> = -10dBm	-4.0	+2.0	dB	
Total harmonic distortion	THD	f = 1kHz, V <sub>O</sub> = 1V, 30kHz L.P.F	0.005	0.1	%	
Crosstalk	C.T.	f = 20kHz, V <sub>IN</sub> = 0dBm, R <sub>g</sub> = 1kΩ	45	55	dB	
Output noise voltage	V <sub>NO</sub>	R <sub>g</sub> = 0Ω, 10Hz to 30kHz B.P.F		25	µV	
Setting error	ΔB		-1	+1	dB	
Frequency response	f (1)	f = 60Hz	±10	±12	±14	dB
	f (2)	f = 150Hz	±10	±12	±14	dB
	f (3)	f = 400Hz	±10	±12	±14	dB
	f (4)	f = 1kHz	±10	±12	±14	dB
	f (5)	f = 2.5kHz	±10	±12	±14	dB
	f (6)	f = 6kHz	±10	±12	±14	dB
	f (7)	f = 15kHz	±10	±12	±14	dB

When operating at f = 1 kHz, all bands flat and V<sub>O</sub> = -10 dB ref at 0 dB

Note: With constant voltage power supply.

In addition to the above items, the STK301-060 is joined by STK301-060A and STK301-060B which differ in crossover frequency.

IC name	f (1)	f (2)	f (3)	f (4)	f (5)	f (6)	f (7)
STK301-060	60Hz	150Hz	400Hz	1kHz	2.5kHz	6kHz	15kHz
STK301-060A	60Hz	125Hz	250Hz	500Hz	1kHz	3.5kHz	10kHz
STK301-060B	60Hz	125Hz	250Hz	500Hz	1kHz	3.5kHz	12kHz

**Internal Equivalent Circuit**

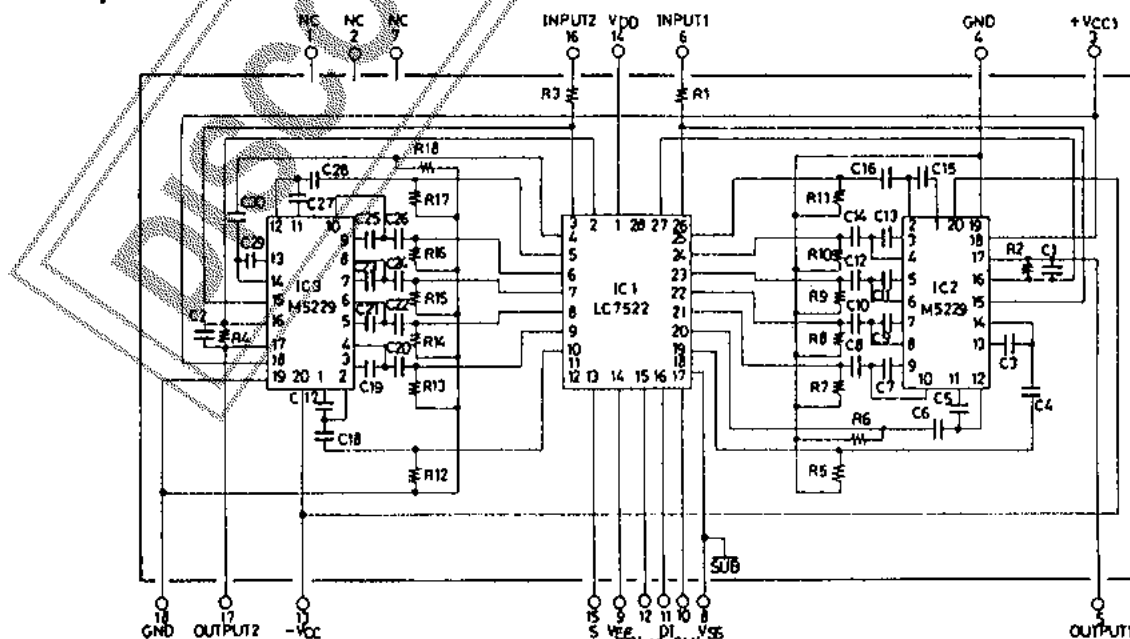

Application Circuit Example

■ + Power Supply

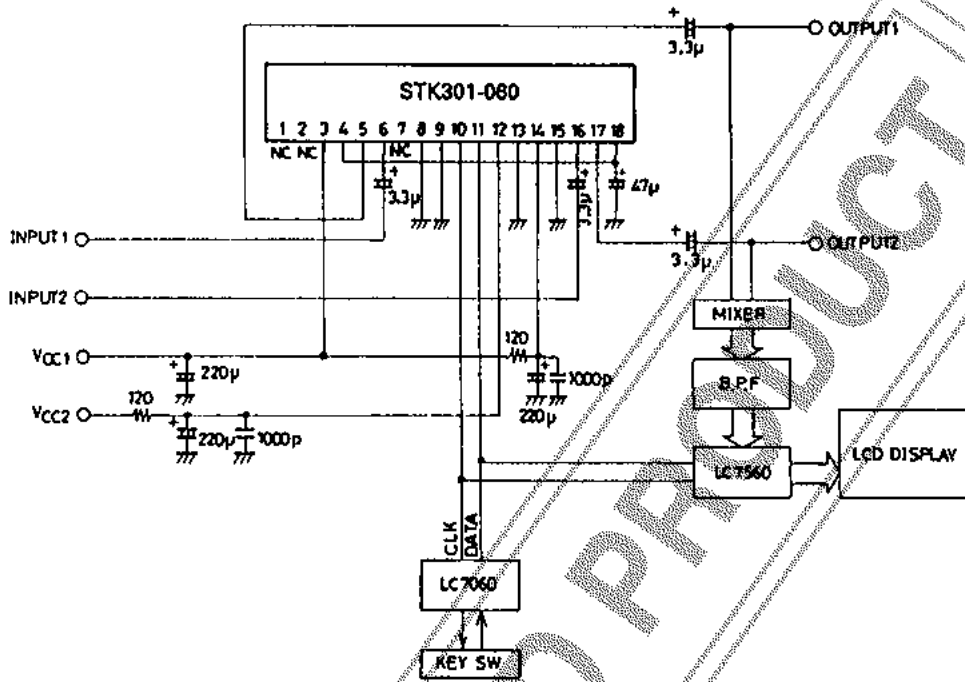

■ ± Power Supply

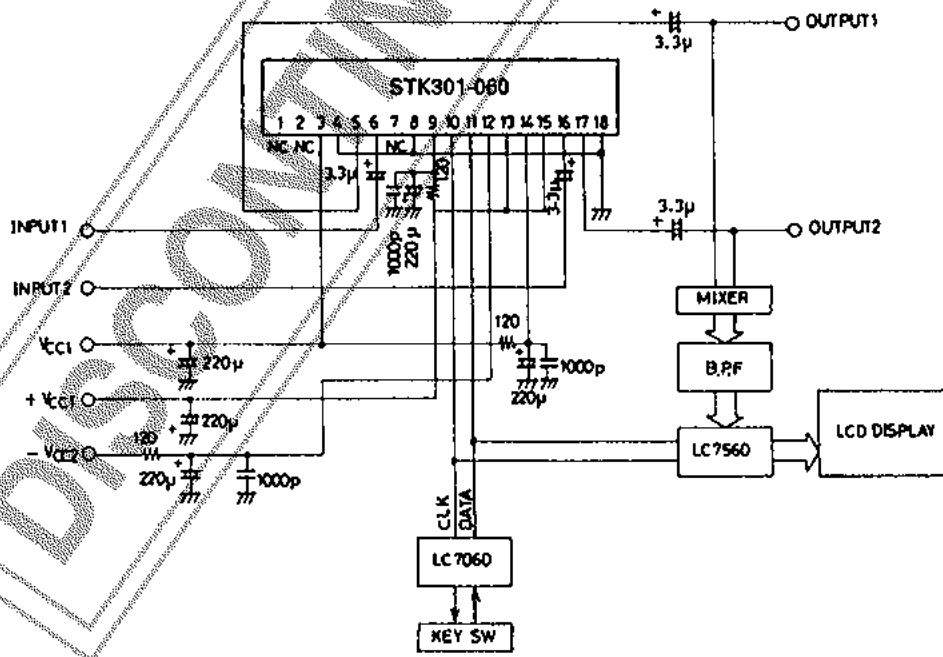

Pin Descriptions

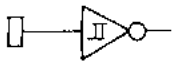
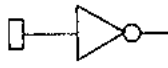
Pin No.	Pin name	Functions
3	+V <sub>CC1</sub>	Power supply pin used for + power supply to IC2 and IC3 graphic equalizer.
4, 18	DC	Pin for 1/2 V <sub>CC2</sub> decoupling capacitor of graphic equalizer IC. When shortened, power supply becomes more effective and ripples are vulnerable.
5	OUTPUT 1	Output pin 1.
6	INPUT 1	Input Impedance for Input pin 1 rated at approximately 80kΩ (1 kHz, flat).
8	V <sub>SS</sub>	Power supply pin connected to ground (GND).
9	V <sub>EE</sub>	Power supply pin used for audio signal power supply to electronic volume section. When single power supply is used, connect to V <sub>SS</sub> .
10	CLK	 Input pin for data from CPU according to Schmitt Inverter format.
11	DI	
12	+V <sub>CC2</sub>	Power supply pin rated at +5 V (typ). Make sure that V <sub>CC2</sub> does not onset before V <sub>DD</sub> .
13	GND (-V <sub>CC1</sub> )	Power supply pin for ground (- power supply) of IC2 and IC3 graphic equalizer.
14	V <sub>DD</sub>	Power supply pin used for audio signal power supply to electronic volume section.
15	S	 Select pin for applications using two ICs. Input "1" to initiate key code 7C3 for connecting to V <sub>DD</sub> . Input "0" to initiate key code 7C2 for connecting to V <sub>EE</sub> .
16	INPUT 2	Input impedance for input pin 2 rated at approximately 80kΩ (1 kHz, flat).
17	OUTPUT 2	Output pin 2.

- Note:
1. Pins 1, 2, 7 are designated as NC pins (pins with no connections).
  2. Refer to LC7522 or LC7523 specifications concerning pins which do not appear here and are hybrid IC (HIC) pins connected directly to a LC7522 or LC7523 pins.

Description of Operation

The STK301-060 is a hybrid IC (HIC) with a 7 - component 2-channel construction for electronically controlled graphic equalizer applications. It employs a LC7522 for graphic equalizer electronic volume and a M5229 for 7 - component graphic equalizer functions.

Equivalent Circuit Block Diagram

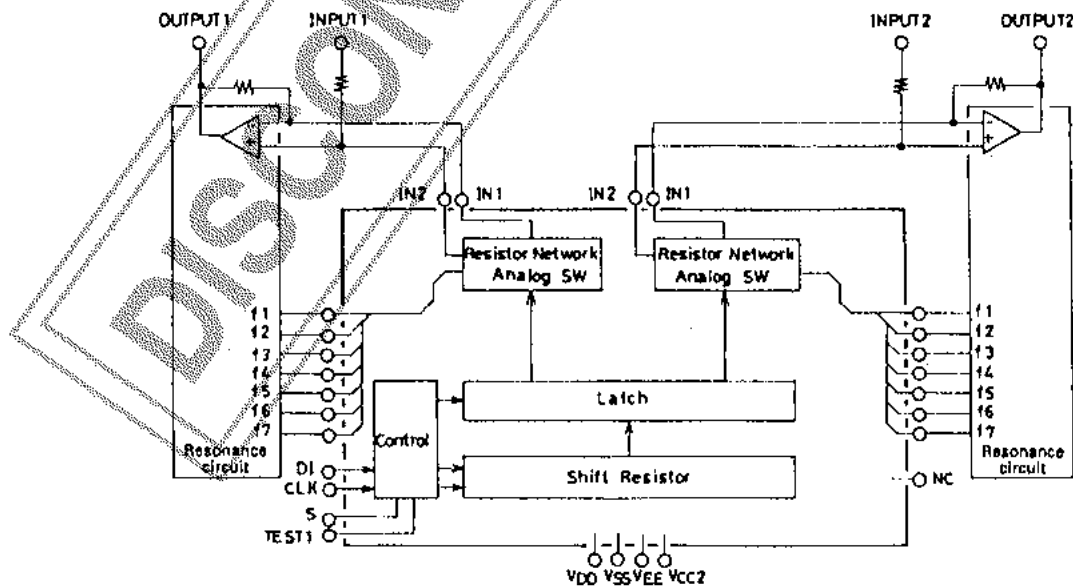
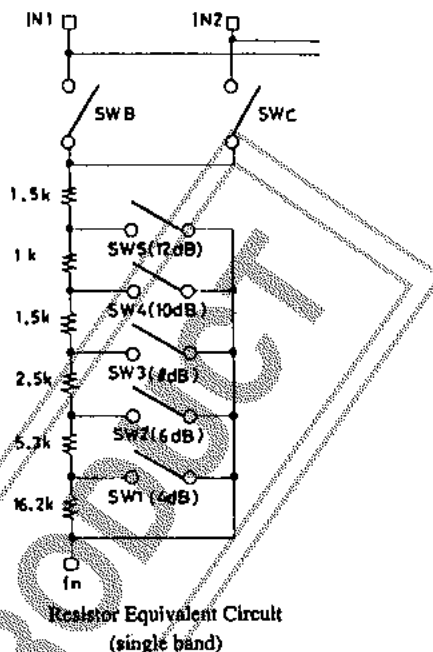

Fig. 1 Equivalent Circuit Block Diagram

Pins f(1) through f(7) are used as pin connections for the LC7522 band filter. Supported frequencies and their pin assignments are listed in the following.

Pin Name	Frequency
f (1)	60Hz
f (2)	150Hz
f (3)	400Hz
f (4)	1kHz
f (5)	2.5kHz
f (6)	6kHz
f (7)	15kHz

In order to minimize the noise which occurs during changeover, connections are made using 1 MΩ resistors from pins f(1) through f(7) to 1/2 V<sub>CC1</sub>.



**Principles of Operation**

The graphic equalizer section is constructed from 7 resonance circuits and output buffer amplifiers (every channel); variable resistors (LC7522) and resonance circuit capacitors C1 and C2 are built-in. Resonance circuits utilize semiconductor inductors and apply resonance to reduced impedance; all frequency gains are altered.

**(1) Resonance Circuit**

Semiconductor inductors replace the L of the R, L, C series resonance circuit with a CR element passing through the buffer function of active elements such as the transistor and op-amp (operational amplifier) thereby effecting the equivalent operation of a R, L, C series resonance circuit. The STK301-060 resonance circuit buffer is constructed using transistors and arranged as illustrated in Figure 2.

Resonance frequency fo is determined using the following formula:

$$f_o = \frac{1}{2\pi \sqrt{C1 \cdot C2 \cdot R1 \cdot R2}}$$

**(2) Flat, Boost and Cut**

Gains matching resonance circuit frequency gains are altered by altering the built-in resonance circuits and electronic volume. Figure 3 is presented to describe the equivalent circuit. Z represents the impedance of the resonance circuit in Figure 2.

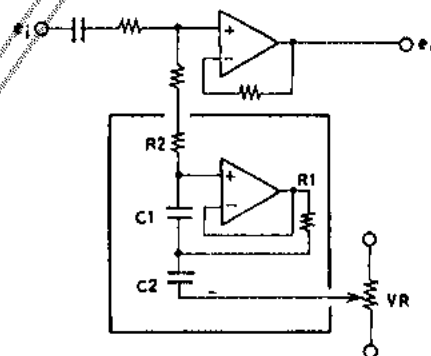
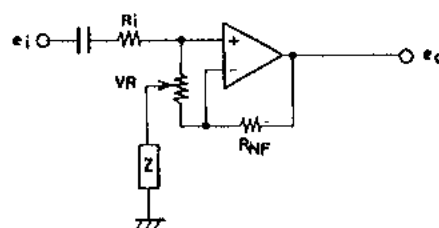

Fig. 2 Resonance Circuit



Z : Resonance circuit impedance  
VR : Equivalent to LC7522

Fig. 3 Equivalent Circuit

(3) Flat

When the volume is set to the midrange position and  $R_i = R_{NF}$ , the following relationships are established:

$$e_i' = \frac{R/2}{R_i = R/2} \cdot e_i$$

$$A_V = \frac{R_{NF} + R/2}{R/2} \text{ in which}$$

$$e_o = A_V \cdot e_i' = e_i$$

with no relation to the resonance circuit and frequency characteristics become flat.

When VR is set to R, the resistance value using a VR sector position becomes R/2.

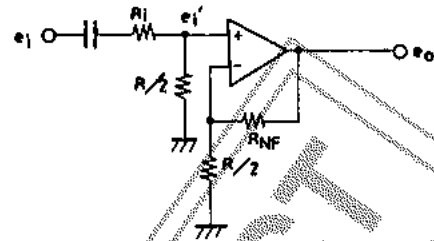

(4) Boost

When the volume is set to the boost position, resonance circuit is linked to the NF loop of the output buffer amplifier. Under these circumstances and when  $R \gg R_i$  and  $R_{NF}$ , the following relationship exist:

$$A_V = \frac{R_{NF} + Z}{Z}$$

is established and output voltage  $e_o$  is calculated as

$$e_o = A_V \cdot e_i = \frac{R_{NF} + Z}{Z} \cdot e_i$$

The gain becomes a minimum when the resonance circuit has Z at a minimum so that the frequency option is boosted.

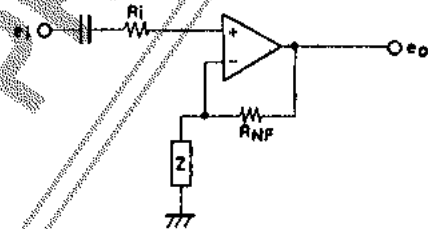

(5) Cut

When volume is set to the cut side, resonance circuit is linked to the input side of the output buffer amplifier. Under these circumstances and when ignoring R similarly to boost, the following relationship exist:

$$e_i' = \frac{Z}{R_i + Z} \cdot e_i, A_V = 1$$

is established and output voltage  $e_o$  is calculated as

$$e_o = A_V \cdot e_i' = \frac{Z}{R_i + Z} \cdot e_i$$

The gain becomes a minimum when the resonance circuit has Z at a minimum so that the frequency option is cut.

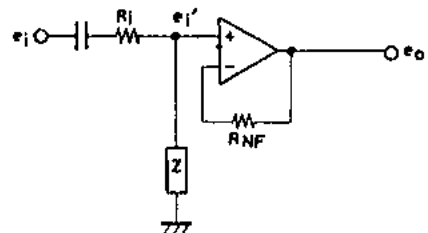

(6) Resonance Circuit Crest Acuteness (Q)

Resonance circuit crest acuteness is determined by comparing frequency widths  $\omega_2 - \omega_1$  for  $G_V \text{ max} / \sqrt{2}$  where  $G_V \text{ max}$  represents point  $\omega_0$  as the maximum value of the resonance circuit crest.

The following formula is used to calculate the value for Q:

$$Q = \sqrt{\frac{C_1 \cdot R_2}{C_2 \cdot R_1}}$$

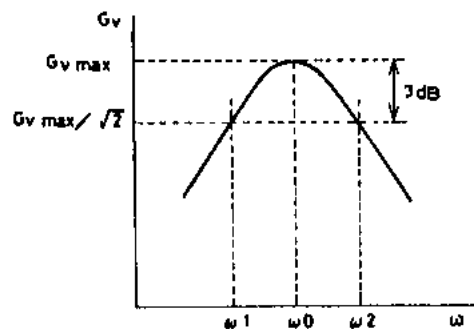

As the value for Q becomes larger, the participating frequency bandwidth of the resonance circuit becomes narrower. Although neighboring bands distinction is precise, the swell of frequency characteristics under total boost is larger while the peak of the resultant frequency is lowered.

With the STK301-060, few crossover bands exist with an increase in swell during total boost. Pass-band-ripple (P.B.R.) width at this time is 4 dB with Q set at 3.5 fore and aft.

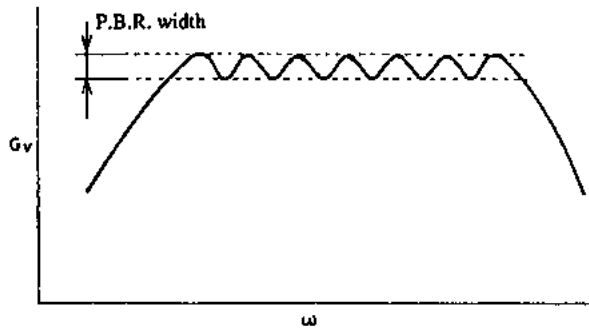

**Data Code**

- (1) Turning on the power initiates a process which transmits no data (0) for 60 clock cycles (initialization clock). When data is stopped in route, the remaining data is sent only after the clock has been initialized.
- (2) Using DI and CLK in conjunction with LC7560 (or equivalent) involves the transmission of the maximum initialization clock to those devices involved.

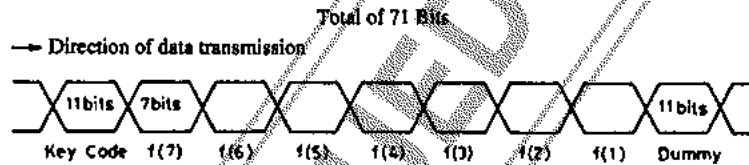
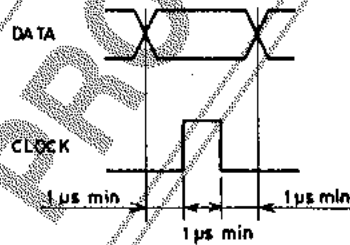

Each band's setting data for left and right channels (7 bits per band)

Direction of transmission →

12 dB	0	0	0	0	1	1	0
10	0	0	0	1	0	1	0
8	0	0	1	0	0	1	0
6	0	1	0	0	0	1	0
4	1	0	0	0	0	1	0
2	0	0	0	0	0	1	0
0	0	0	0	0	0	0	0
-2	0	0	0	0	0	0	1
-4	1	0	0	0	0	0	1
-6	0	1	0	0	0	0	1
-8	0	0	1	0	0	0	1
-10	0	0	0	1	0	0	1
-12	0	0	0	0	1	0	1

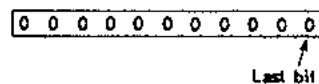
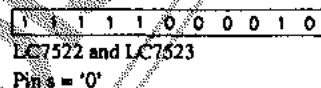

**Things to Note**

1. A 1000pF-rated capacitor (or higher) should be installed between the current pin and  $V_{SS}$ .
2. When the control signal on the microcontroller side onsets faster than STK301-060's  $V_{DD}$ , a resistor rated at  $2k\Omega$  or more should be placed on the DI and CLK line.
3. Since the STK301-060 is equipped with a built-in CMOS LSI, sufficient caution should be extended to damage caused by static electricity.
4. Refer to the specification sheet for itemized details about the LC7522.

STK301-060

STK301-060 Frequency response

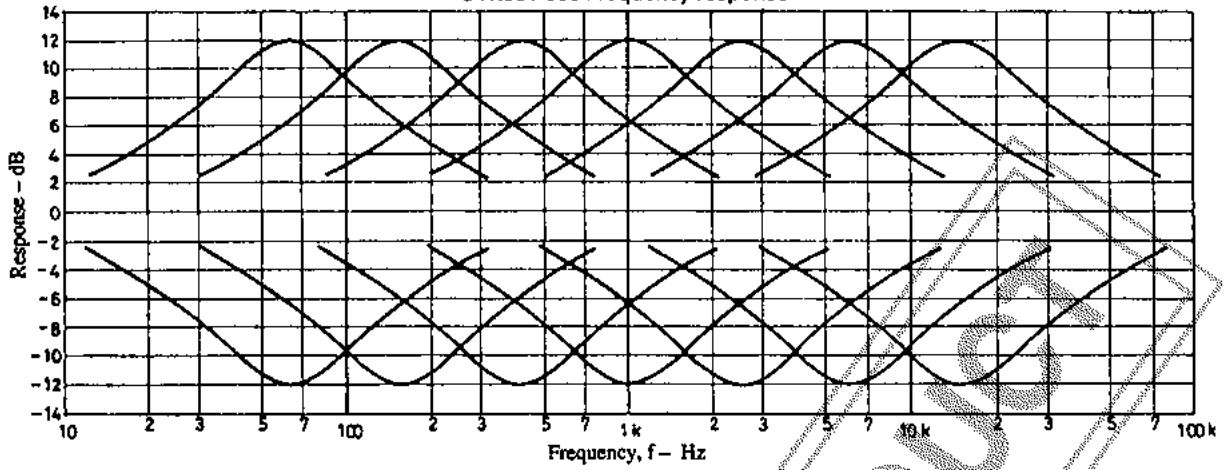

STK301-060A Frequency response

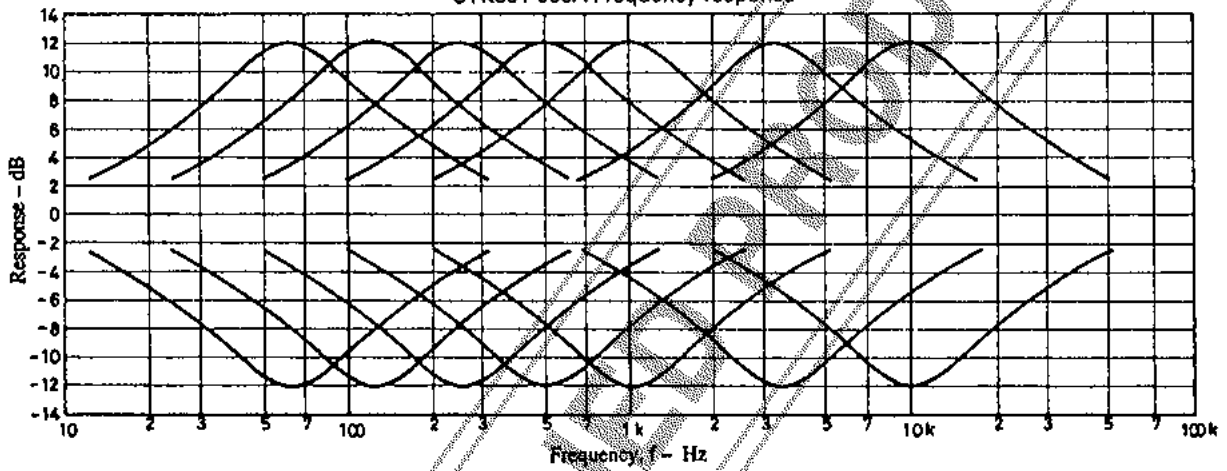

STK301-060B Frequency response

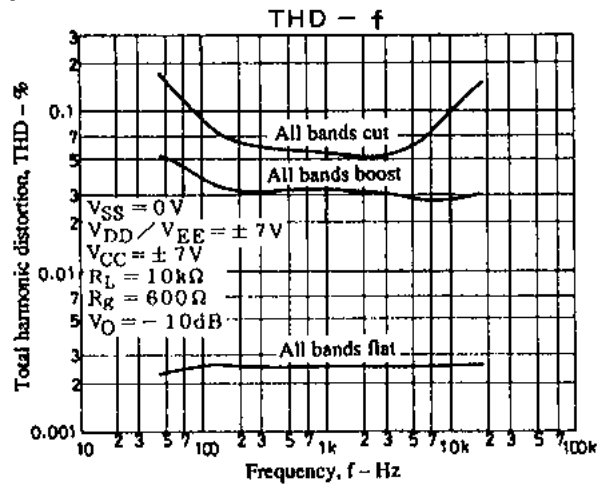
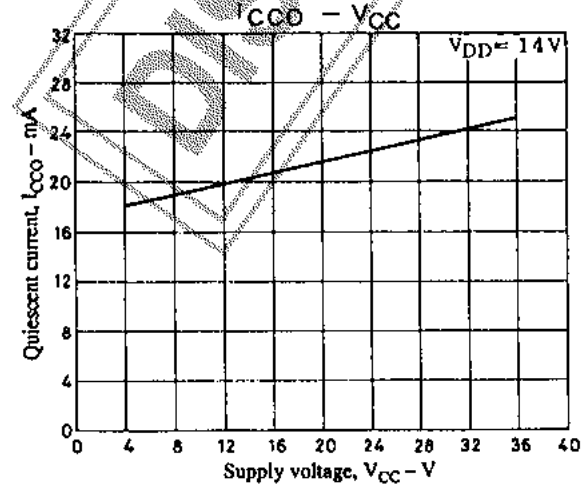
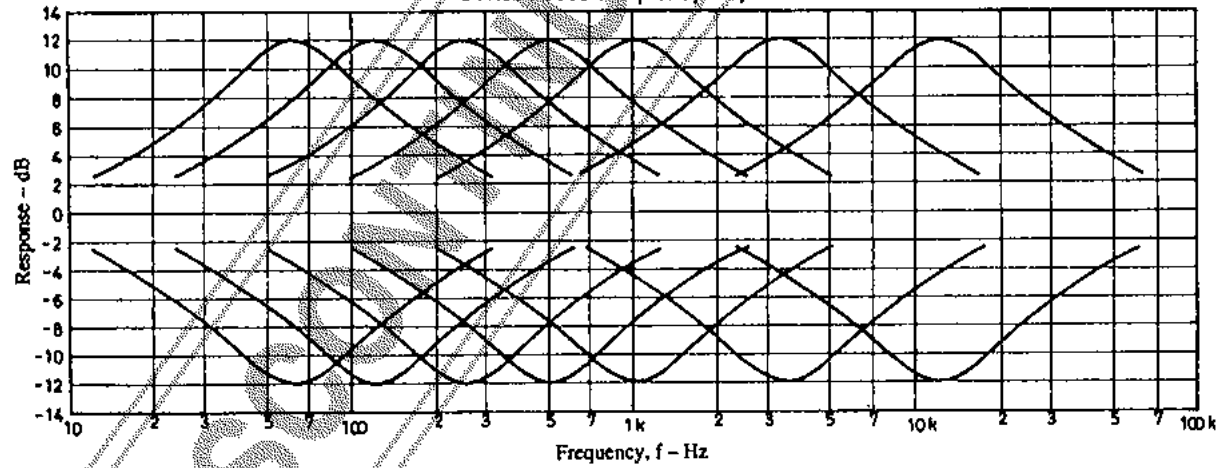



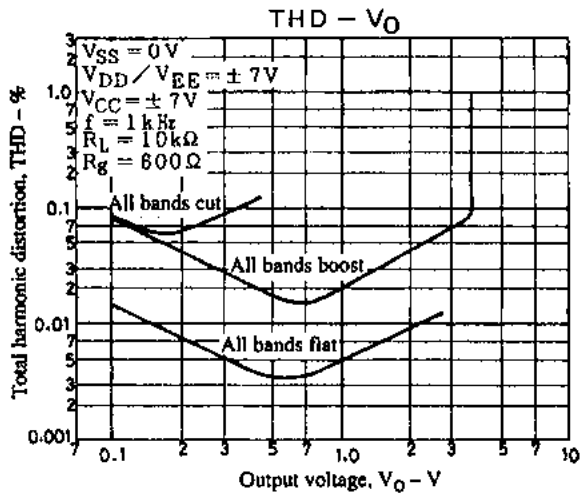

DISCONTINUED PRODUCT

Information (including circuit diagrams and circuit parameters) herein is for example only ; it is not guaranteed for volume production.

SANYO believes information herein is accurate and reliable, but no guarantees are made or implied regarding its use or any infringements of intellectual property rights or other rights of third parties.