

Telecom Switch - 1 Form A Solid State Relay

Features

- Solid State Relay and Optocoupler in One Package
- Surface Mount Package
- I/O Isolation, 5300 V_{RMS}
- LH1529A, CTR Min. = 33 %
- LH1529B, CTR Min. = 100 %
- Optocoupler
 - Bidirectional Current Detection
- Solid-state Relay (Equivalent to TS117P)
 - Typical R_{ON} 20 Ω
 - Load Voltage 350 V
 - Load Current 120 mA
 - Current Limit Protection
 - High Surge Capability
 - Clean Bounce Free Switching
 - Low Power Consumption
 - High Reliability Monolithic Receptor
- Lead-free component
- Component in accordance to RoHS 2002/95/EC and WEEE 2002/96/EC

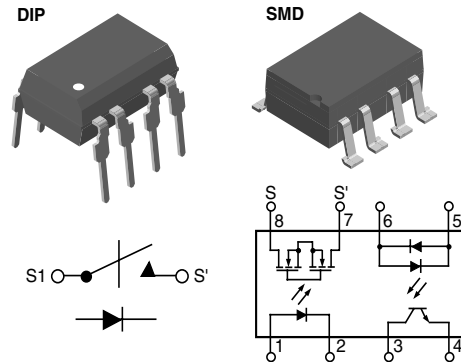

1179049



Applications

General Telecom Switching

- On/off Hook Control
- Dial Pulse
- Ring Current Detection
- Loop Current Sensing

See "Solid State Relays" (Application Note 56)

Description

The LH1529A and LH1529B Telecom switches consist of an optically coupled solid state relay (SSR) and bidirectional input optocoupler. The SSR is ideal for performing switch hook and dial-pulse switching while optocoupler performs ring detection and loop current sensing functions. Both the SSR and optocoupler pro-

Agency Approvals

- UL1577, File No. E52744 System Code H or J, Double Protection
- BSI/BABT Cert. No. 7980
- FIMKO Approval

Absolute Maximum Ratings, T_{amb} = 25 °C

Stresses in excess of the absolute Maximum Ratings can cause permanent damage to the device. Functional operation of the device is not implied at these or any other conditions in excess of those given in the operational sections of this document. Exposure to absolute Maximum Ratings for extended periods of time can adversely affect reliability.

SSR

Parameter	Test condition	Symbol	Value	Unit
LED continuous forward current		I _F	50	mA
LED reverse voltage	I _R ≤ 10 μA	V _R	5.0	V
DC or peak AC load voltage	I _L ≤ 50 μA	V _L	350	V
Continuous DC load current		I _L	120	mA
Total power dissipation		P _{diss}	600	mW
Ambient temperature range		T _{amb}	- 40 to + 85	°C
Storage temperature range		T _{stg}	- 40 to + 150	°C
Soldering temperature	t = 10 s max.	T _{slid}	260	°C

Parameter	Test condition	Symbol	Value	Unit
Isolation test voltage (for 1.0 s)		V_{ISO}	5300	V_{RMS}
Isolation resistance	$V_{IO} = 500\text{ V}, T_{amb} = 25\text{ °C}$	R_{IO}	$\geq 10^{12}$	Ω
	$V_{IO} = 500\text{ V}, T_{amb} = 100\text{ °C}$	R_{IO}	$\geq 10^{11}$	Ω

Optocoupler

Parameter	Test condition	Symbol	Value	Unit
LED continuous forward current		I_F	50	mA
LED reverse voltage	$I_R \leq 10\text{ }\mu\text{A}$	V_R	5.0	V
Collector-emitter breakdown voltage		BV_{CEO}	30	V
Phototransistor power dissipation		P_{diss}	150	mW

Electrical Characteristics, $T_{amb} = 25\text{ °C}$

Minimum and maximum values are testing requirements. Typical values are characteristics of the device and are the result of engineering evaluations. Typical values are for information only and are not part of the testing requirements.

SSR

Parameter	Test condition	Part	Symbol	Min	Typ.	Max	Unit
LED forward current for switch turn-on	$I_L = 100\text{ mA}, t = 10\text{ ms}$		I_{Fon}		0.7	2.0	mA
LED forward current for switch turn-off	$V_L = \pm 300\text{ V}$		I_{Foff}	0.2	0.6		mA
LED forward voltage	$I_F = 10\text{ mA}$		V_F	1.15	1.26	1.45	V
ON- resistance, AC/DC, pins 4 (\pm) to 6 (\pm)	$I_F = 5.0\text{ mA}, I_L = \pm 50\text{ mA}$		R_{ON}	12	20	25	Ω
Current limit	$I_F = 5.0\text{ mA}, t = 5.0\text{ ms}, V_L = \pm 6.0\text{ V}$	LH1529AB	I_{limit}	230	260	370	mA
		LH1529AAC	I_{limit}	230	260	370	mA
		LH1529BB	I_{limit}	170	210	250	mA
		LH1529BAC	I_{limit}	170	210	250	mA
Off-state leakage current	$I_F = 0\text{ mA}, V_L = \pm 100\text{ V}$		I_O		0.02	200	nA
	$I_F = 0\text{ mA}, V_L = \pm 350\text{ V}$		I_O			1.0	μA
Output capacitance pin 7 to pin 8	$I_F = 0\text{ mA}, V_L = 1\text{ V}$		C_O		55		pF
	$I_F = 0\text{ mA}, V_L = 50\text{ V}$		C_O		10		pF
Capacitance (input-output)	$V_{ISO} = 1.0\text{ V}$		C_{IO}		1.3		pF
Turn-on time	$I_F = 5.0\text{ mA}, I_L = 50\text{ mA}$	LH1529AB	t_{on}		2.0	3.0	ms
		LH1529AAC	t_{on}		2.0	3.0	ms
		LH1529BB	t_{on}		1.3	2.5	ms
		LH1529BAC	t_{on}		1.3	2.5	ms
Turn-off time	$I_F = 5.0\text{ mA}, I_L = 50\text{ mA}$	LH1529AB	t_{off}		0.6	3.0	ms
		LH1529AAC	t_{off}		0.6	3.0	ms
		LH1529BB	t_{off}		0.6	2.5	ms
		LH1529BAC	t_{off}		0.6	2.5	ms

Optocoupler

Parameter	Test condition	Part	Symbol	Min	Typ.	Max	Unit
LED forward voltage	$I_F = 10 \text{ mA}$		V_F	0.9	1.2	1.5	V
Saturation voltage	$I_F = 16 \text{ mA}, I_C = 2.0 \text{ mA}$		V_{CEsat}		0.7	0.5	V
Collector-emitter dark current	$I_F = 0 \text{ mA}, V_{CE} = 5.0 \text{ V}$		I_{CEO}			500	nA
Trickle current leakage	$I_F = 5.0 \mu\text{A}, V_{CE} = 5.0 \text{ V}$		I_{CEO}			1.0	μA
DC Current Transfer Ratio	$I_F = 6.0 \text{ mA}, V_{CE} = 0.5 \text{ V}$	LH1529AB	CTR_{DC}	33	100		%
		LH1529AAC	CTR_{DC}	33	100		%
		LH1529BB	CTR_{DC}	100	165		%
		LH1529BAC	CTR_{DC}	100	165		%

Typical Characteristics ($T_{amb} = 25^\circ\text{C}$ unless otherwise specified)

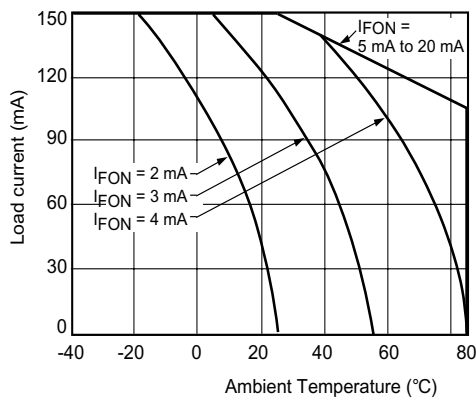

ih1529ab_00

Figure 1. Recommended Operating Conditions

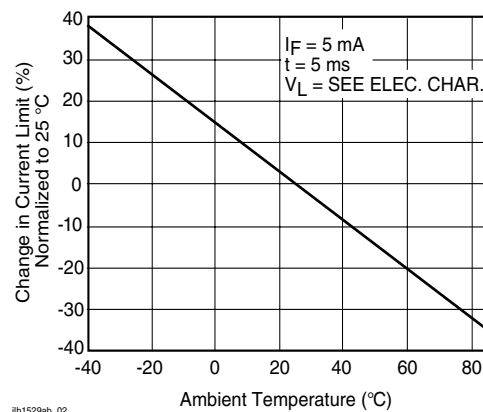

ih1529ab_02

Figure 3. Current Limit vs. Temperature

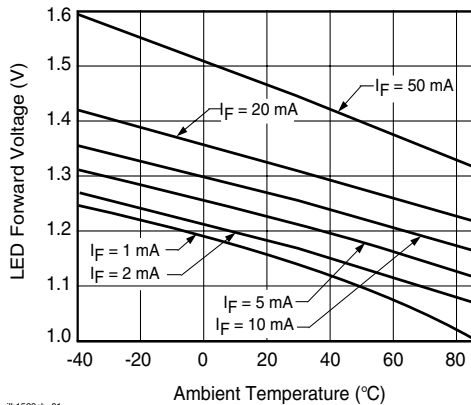

ih1529ab_01

Figure 2. LED Voltage vs. Temperature

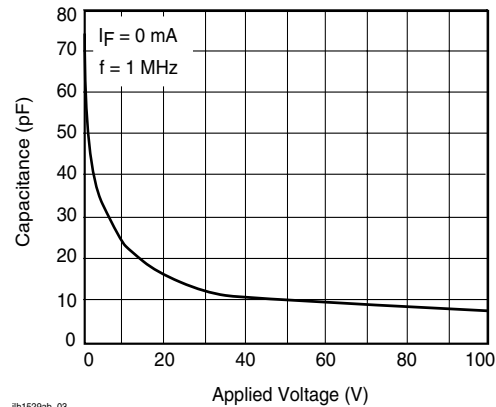

ih1529ab_03

Figure 4. Switch Capacitance vs. Applied Voltage

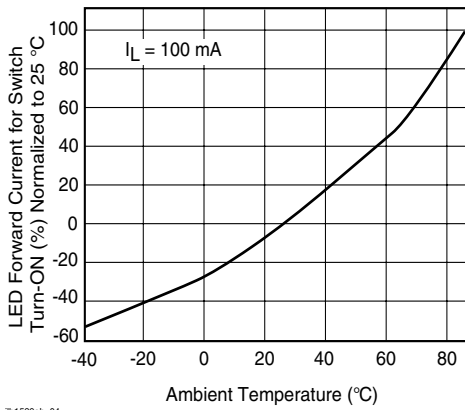

ih1529ab_04

Figure 5. LED Current for Switch Turn-off vs. Temperature

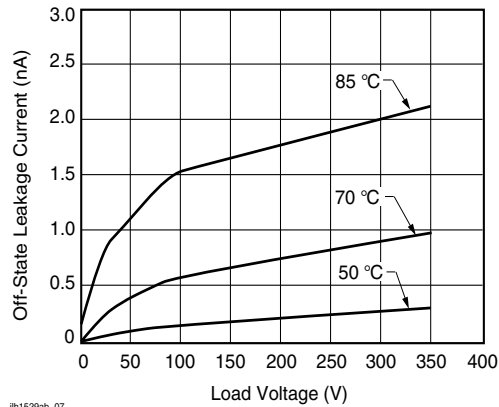

ih1529ab_07

Figure 8. Leakage Current vs. Applied Voltage at Elevated Temperatures

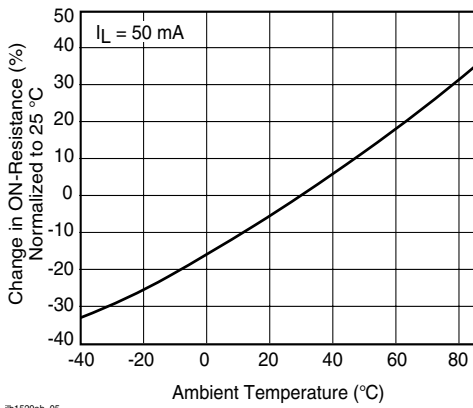

ih1529ab_05

Figure 6. ON-Resistance vs. Temperature

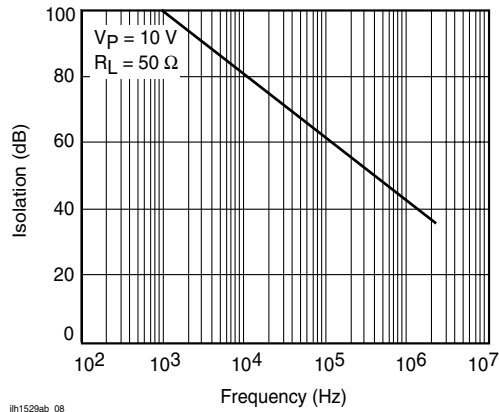

ih1529ab_08

Figure 9. Output Isolation

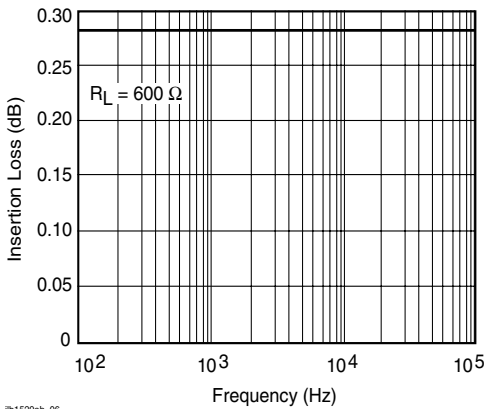

ih1529ab_06

Figure 7. Insertion Loss vs. Frequency

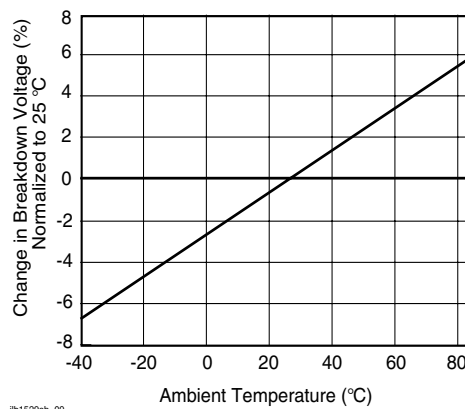

ih1529ab_09

Figure 10. Switch Breakdown Voltage vs. Temperature

Figure 11. Leakage Current vs. Applied Voltage

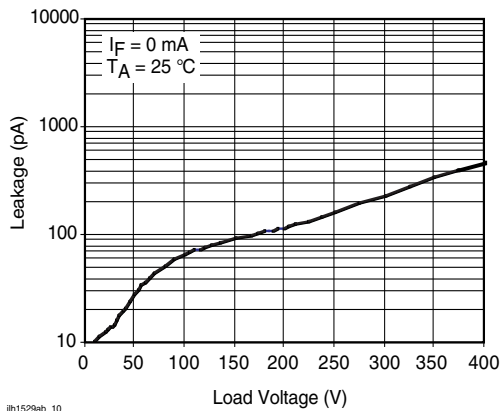

Package Dimensions in Inches (mm)

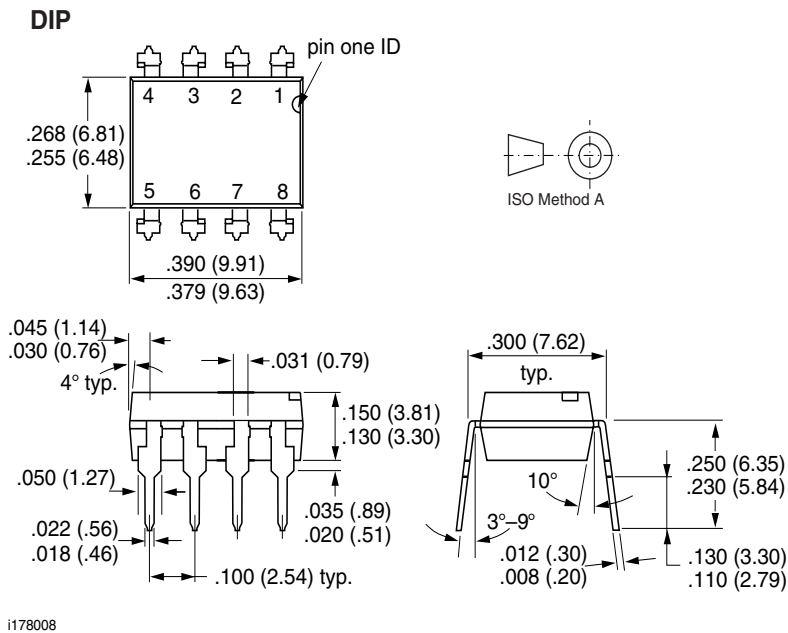

i178008

LH1529AB/AAC/AACR/BB/BAC/



Vishay Semiconductors

Package Dimensions in Inches (mm)

SMD

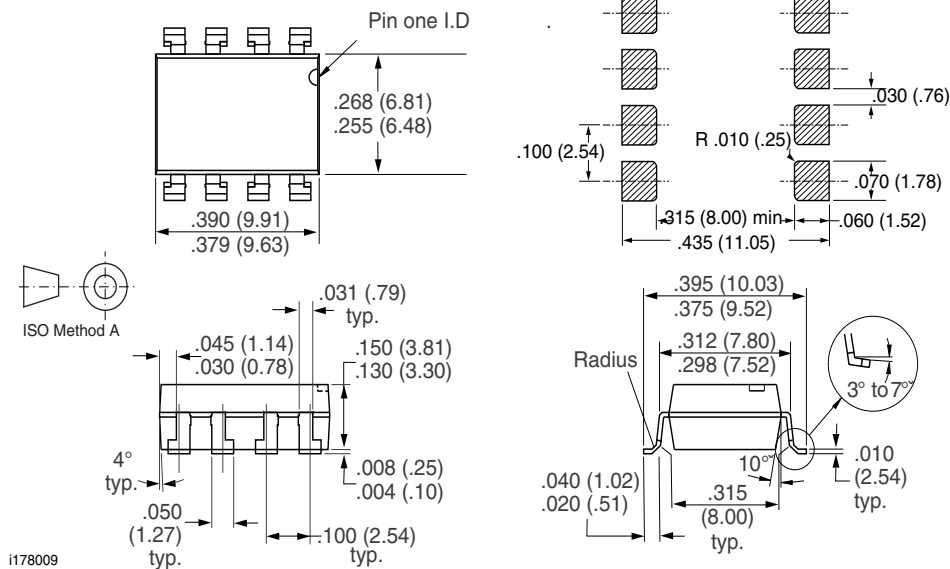



Ozone Depleting Substances Policy Statement

It is the policy of Vishay Semiconductor GmbH to

1. Meet all present and future national and international statutory requirements.
2. Regularly and continuously improve the performance of our products, processes, distribution and operating systems with respect to their impact on the health and safety of our employees and the public, as well as their impact on the environment.

It is particular concern to control or eliminate releases of those substances into the atmosphere which are known as ozone depleting substances (ODSs).

The Montreal Protocol (1987) and its London Amendments (1990) intend to severely restrict the use of ODSs and forbid their use within the next ten years. Various national and international initiatives are pressing for an earlier ban on these substances.

Vishay Semiconductor GmbH has been able to use its policy of continuous improvements to eliminate the use of ODSs listed in the following documents.

1. Annex A, B and list of transitional substances of the Montreal Protocol and the London Amendments respectively
2. Class I and II ozone depleting substances in the Clean Air Act Amendments of 1990 by the Environmental Protection Agency (EPA) in the USA
3. Council Decision 88/540/EEC and 91/690/EEC Annex A, B and C (transitional substances) respectively.

Vishay Semiconductor GmbH can certify that our semiconductors are not manufactured with ozone depleting substances and do not contain such substances.

We reserve the right to make changes to improve technical design and may do so without further notice.

Parameters can vary in different applications. All operating parameters must be validated for each customer application by the customer. Should the buyer use Vishay Semiconductors products for any unintended or unauthorized application, the buyer shall indemnify Vishay Semiconductors against all claims, costs, damages, and expenses, arising out of, directly or indirectly, any claim of personal damage, injury or death associated with such unintended or unauthorized use.

Vishay Semiconductor GmbH, P.O.B. 3535, D-74025 Heilbronn, Germany
Telephone: 49 (0)7131 67 2831, Fax number: 49 (0)7131 67 2423



Disclaimer

All product specifications and data are subject to change without notice.

Vishay Intertechnology, Inc., its affiliates, agents, and employees, and all persons acting on its or their behalf (collectively, "Vishay"), disclaim any and all liability for any errors, inaccuracies or incompleteness contained herein or in any other disclosure relating to any product.

Vishay disclaims any and all liability arising out of the use or application of any product described herein or of any information provided herein to the maximum extent permitted by law. The product specifications do not expand or otherwise modify Vishay's terms and conditions of purchase, including but not limited to the warranty expressed therein, which apply to these products.

No license, express or implied, by estoppel or otherwise, to any intellectual property rights is granted by this document or by any conduct of Vishay.

The products shown herein are not designed for use in medical, life-saving, or life-sustaining applications unless otherwise expressly indicated. Customers using or selling Vishay products not expressly indicated for use in such applications do so entirely at their own risk and agree to fully indemnify Vishay for any damages arising or resulting from such use or sale. Please contact authorized Vishay personnel to obtain written terms and conditions regarding products designed for such applications.

Product names and markings noted herein may be trademarks of their respective owners.