

TRIGGER DIODES

FEATURES

- * V_{BO} : 32V/34V/40V VERSIONS
- * Low Breakover Current

DESCRIPTION

- * High reliability glass passivation insuring parameter stability and protection against junction contamination
- * JEDEC DO213AA case
- * Weight: 0.0306 grams



DO213AA(LL-34)

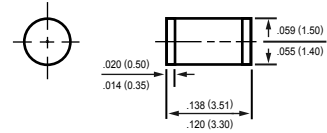

Dimensions in inches and (millimeters)

MAXIMUM RATINGS (At $T_A = 25^\circ\text{C}$ unless otherwise noted)

RATING	SYMBOL	VALUE	UNITS
Repetitive Peak On-State Current $t_p=20\mu\text{s}, F=100\text{Hz}$	I_{TRM}	2	A
Power Dissipation (@ $T_A=50^\circ\text{C}$) Derate Above $+50^\circ\text{C}$	P	150	mW
		4.0	mW/ $^\circ\text{C}$
Storage Temperature Range	T_{STG}	-40 to + 125	$^\circ\text{C}$
Junction Temperature	T_J	125	$^\circ\text{C}$

ELECTRICAL CHARACTERISTICS (At $T_A = 25^\circ\text{C}$ unless otherwise noted)

RATING	SYMBOL	VALUE				UNITS
		DB3S-1		DB3S-2		
Breakover Voltage(Forward and Reverse) at $I_{BO}, C=22\text{nF}^{**}$	V_{BO}	Min	Max	Min	Max	Volts
		30	34	28	36	
Maximum Breakover Voltage Symmetry $\Delta V_{BO} = V_{BO} - V_{BO} $ $C=22\text{nF}$	ΔV_{BO}	+/-2				Volts
Minimum Dynamic Breakover Voltage $\Delta I = I_{BO}$ to $I_F=10\text{mA}$ (see Fig3)	$ \Delta V_{+/-} $	5				Volts
Minimum Output Voltage* (see Fig 2)	V_O	5				Volts
Peak Breakover Current at Breakover Voltage* $C=22\text{nF}^{**}$	I_{BO}	25		100		μA
Rise Time* (see Fig3)	t_r	1.5				μs
Leakage Current* $V_B=0.5V_{BO}$ max (see Fig1)	I_B	10				μA

- NOTES: 1. *Electrical characteristic applicable in both forward and reverse directions.
 2.**Connected in parallel with the devices.
 3. "Fully ROHS compliant", "100% Sn plating (Pb-free)".

RATING AND CHARACTERISTICS CURVES (DB3S)

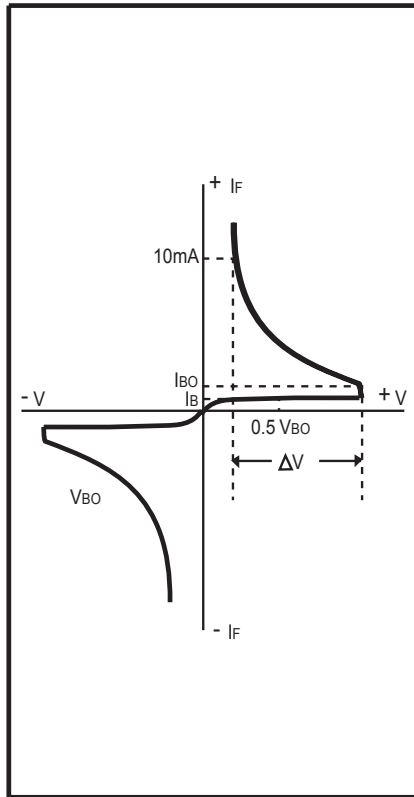

FIG.1 Current-voltage characteristics

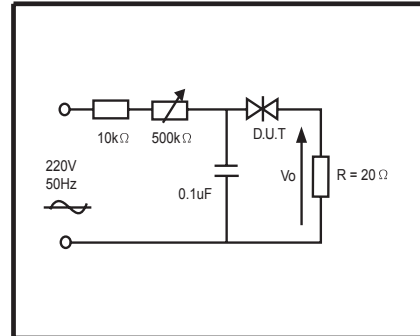

FIG.2 Test circuit for output voltage

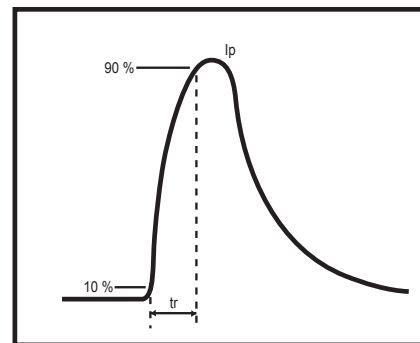

FIG.3 Test circuit see Fig.2
Adjust R for $I_p=0.5A$

RATING AND CHARACTERISTICS CURVES (DB3S)

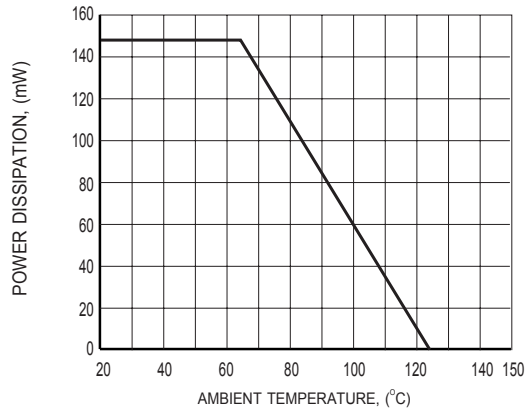

FIG.4 POWER DISSIPATION VERSUS AMBIENT TEMPERATURE (MAXIMUM VALUES)

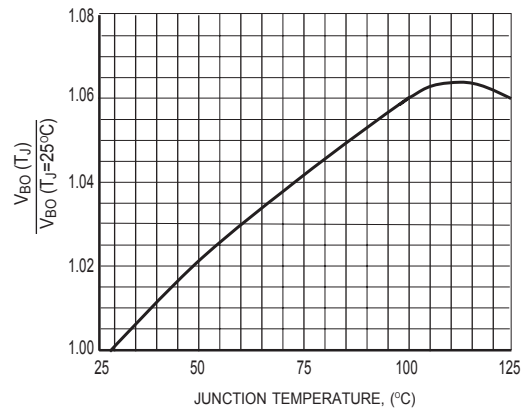

FIG.5 RELATIVE VARIATION OF V_{BO} VERSUS JUNCTION TEMPERATURE (TYPICAL VALUES)

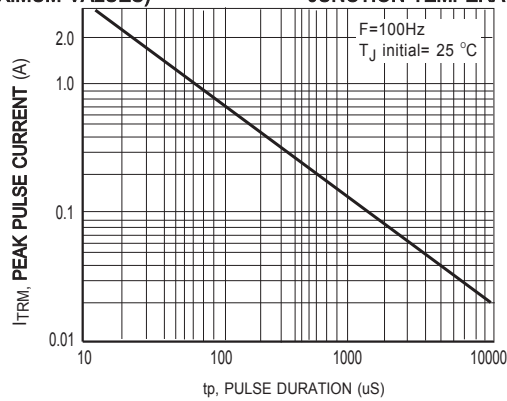
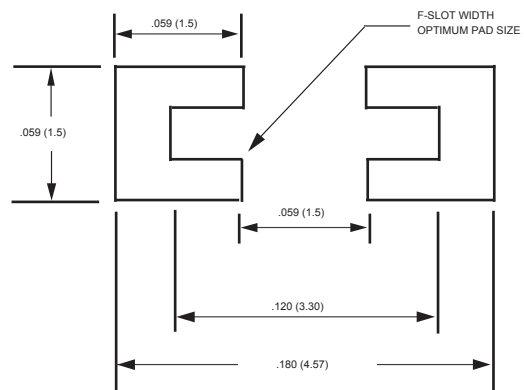

FIG.6 PEAK PULSE CURRENT VERSUS PULSE DURATION (MAXIMUM VALUES)

Mounting Pad Layout (LL-34)



Dimensions in inches and (millimeters)

DISCLAIMER NOTICE

Rectron Inc reserves the right to make changes without notice to any product specification herein, to make corrections, modifications, enhancements or other changes. Rectron Inc or anyone on its behalf assumes no responsibility or liability for any errors or inaccuracies. Data sheet specifications and its information contained are intended to provide a product description only. "Typical" parameters which may be included on RECTRON data sheets and/ or specifications can and do vary in different applications and actual performance may vary over time. Rectron Inc does not assume any liability arising out of the application or use of any product or circuit.

Rectron products are not designed, intended or authorized for use in medical, life-saving implant or other applications intended for life-sustaining or other related applications where a failure or malfunction of component or circuitry may directly or indirectly cause injury or threaten a life without expressed written approval of Rectron Inc. Customers using or selling Rectron components for use in such applications do so at their own risk and shall agree to fully indemnify Rectron Inc and its subsidiaries harmless against all claims, damages and expenditures.