

GPS Antenna GPA-CG2C2

OUTLINE

This is a highly sensitive, efficient antenna for receiving GPS satellite waves. It is ideal for use as a built-in antenna for portable/handy equipment. Antenna pattern is custom designed to meet the customer's requirements.

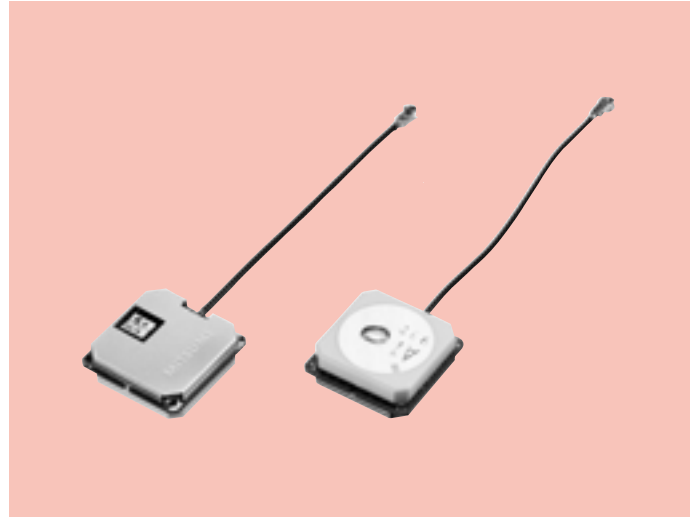

FEATURES

1. Custom antenna pattern design.
2. Low power supply voltage, low consumption current.
3. Small antenna element 20(W)×20(D)×4(H) mm.
4. Cable length and connector can be customized.

SPECIFICATIONS

Item		Specifications
Antenna	Reception Frequency	1575.42±1.023MHz
	Reception Polarization	Right Hand Circular Polarization
	Antenna Gain	1.0dBi typ. *1
	Output Impedance	50Ω
LNA	Reception Frequency	1575.42MHz
	Noise Factor	1.1dB typ.
	Gain	26dB typ.
	Gain Flatness (Within Reception Band)	1dB max.
	Ex-band Attenuation	18dB min. (fo±50MHz)
Overall	Overall Gain	26dBi typ.(Zenith) *1
	Power Supply Voltage	3.0V
	Current Consumption	6.5mA typ. 8mA max.
Minimum Order		50,000pcs/year

*1 Conditions : on the 22×22mm grand board. Cable length 100mm.

DIMENSIONS

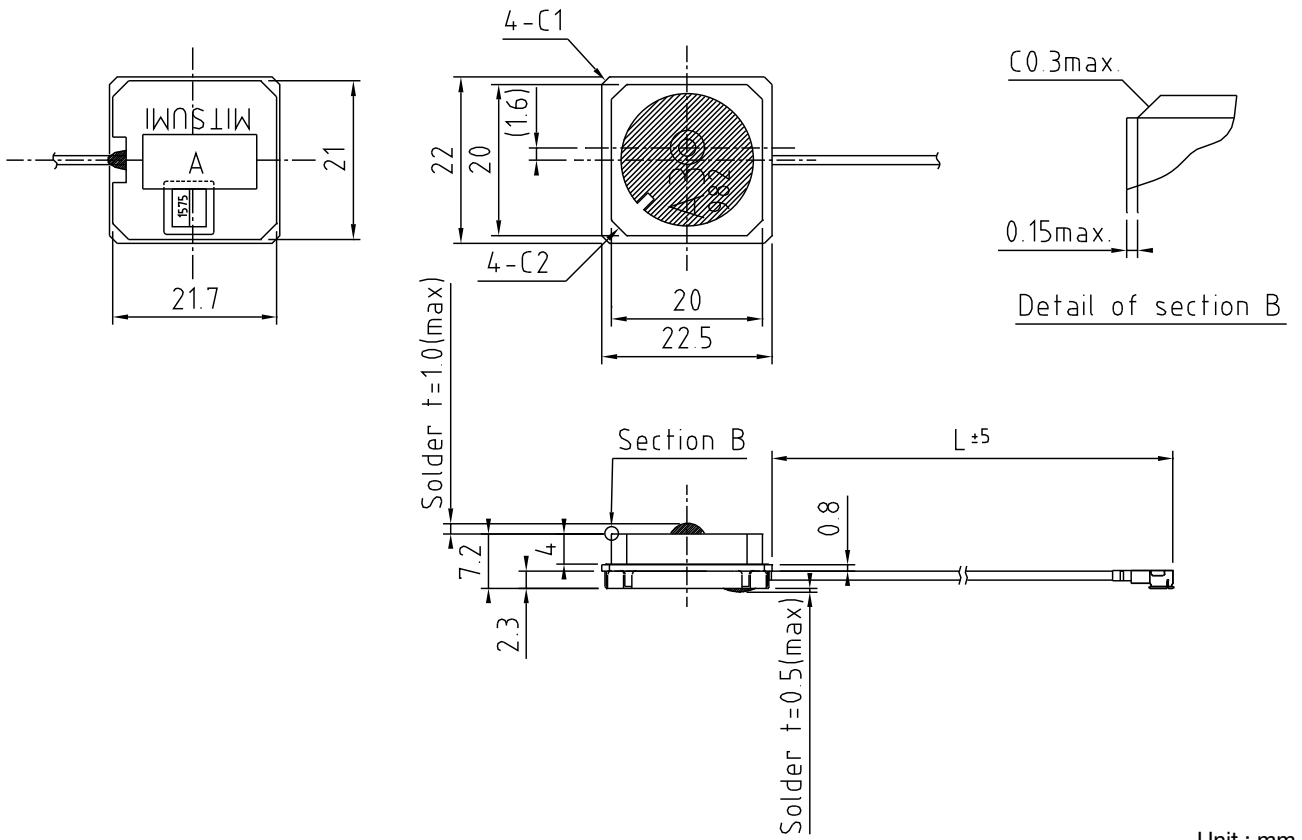

Unit : mm