

## DBR Fiber-Pigtailed Laser with built in isolator

DBR1064P



S/N: DBR-32683

Wavelength: 1063.0nm  
Fiber Type: PM980-XP  
Test Date: 11/20/2018



Package: 1064-2-2-Y-P-A  
Connector: FC/APC  
Tested By: Paya



QA: Pass

### Summary of Test Data ( CW )

Parameter	Symbol	Value	Unit
Operating Current	$I_{op}$	150.0	mA
Operating Temperature	$T_{op}$	25.0	°C
Fiber Output Power @ $I_{op}, T_{op}$	$P_{out}$	32.8	mW
Voltage @ $I_{op}, T_{op}$	$V_F$	1.46	V
Monitor Current @ $I_{op}, T_{op}$	$I_{mon}$	0.125	mA
SMSR @ $I_{op}, T_{op}$	SMSR	52.3	dB
Threshold Current @ $T_{op}$	$I_{th}$	27.2	mA
Slope Efficiency @ $T_{op}$	$\Delta P / \Delta I$	0.27	W/A
Current Tuning	$\Delta \lambda / \Delta I$	0.0022	nm/mA
Temperature Tuning	$\Delta \lambda / \Delta T$	0.075	nm/°C

### Absolute Maximum Ratings

Parameter	Ratings	Unit
Laser Diode Current*	200	mA
Optical Output Power*	50	mW
LD Reverse Voltage*	2	V
Storage Temperature	-10~+65	°C
Case Temperature	0~+50	°C

\* CW,  $T_{case}=25^{\circ}C$

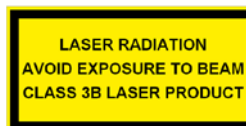

CAUTION- use of controls or adjustments or performance of procedures other than those specified herein may result in hazardous radiation exposure. There are no user serviceable parts in this product. When proper power is applied to this product, Laser radiation will be emitted from the optical fiber.

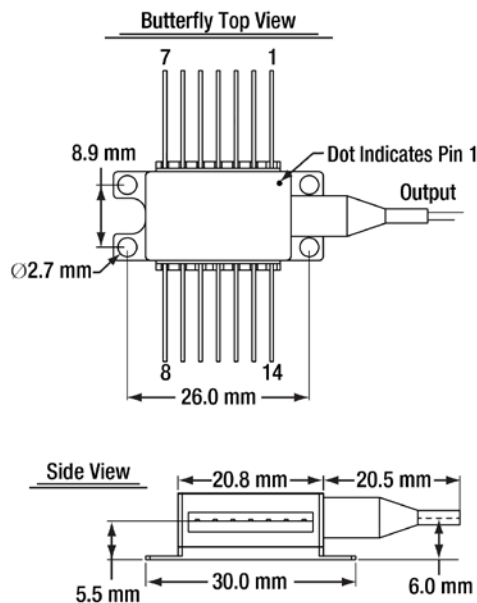

PIN IDENTIFICATION	
1. TEC +	14. TEC -
2. Thermistor	13. Case
3. PD Anode	12. NC
4. PD Cathode	11. LD Cathode
5. Thermistor	10. LD Anode
6. NC	9. NC
7. NC	8. NC

### Important Notes:

- The maximum ratings mean the limitation over which the laser should not be operated even instant time.
- Do not clean the fiber connector when the diode is in operation. The laser should be off when plugging or un-plugging the connector.**
- To protect the laser diode from damage due to static electricity (ESD), please follow proper ESD handling precautions.
- Do not pull or fold the fiber. The fiber is very fragile and easily broken. Avoid handling the fiber by the rubber "boots" of the black housing and connector ends of the pigtail.
- To ensure safe operation use only with a suitable power source that complies with the pertinent requirements for laser systems as specified in IEC-60825-1 "Safety of Laser Products."



Thorlabs Inc 56 Sparta Avenue Newton, New Jersey 07860 USA	US, Canada & South America 1-973-300-3000 Brazil +55-16-3413 7062	France +33 (0)970 440 844 Scandinavia +46-31-733-30-00	Europe +49 (0) 8131-5956-0 Japan & Asia +81-3-6915-7701	UK & Ireland +44 (0)1353-654440 China +86 (0)21-60561122
---	--	---	--	---

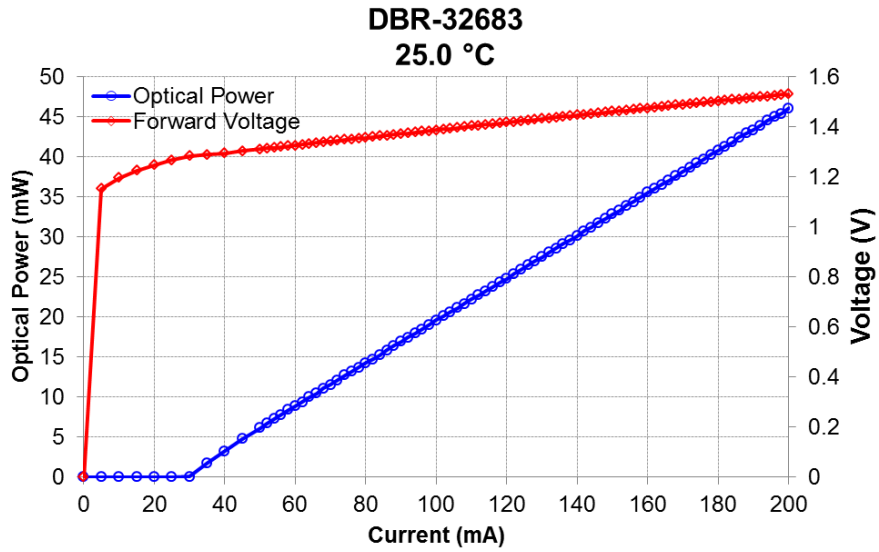

Figure 1: Output Power and Operating Voltage versus Bias Current

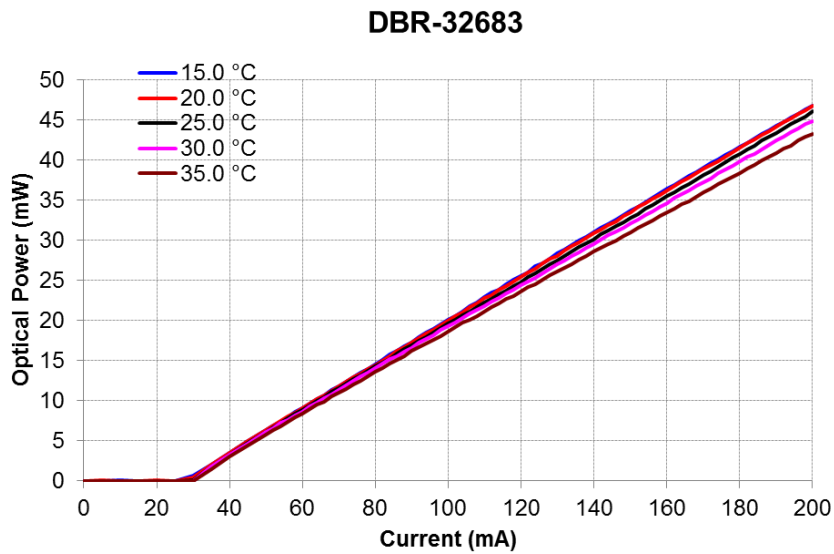

Figure 2: Output Power versus Bias Current

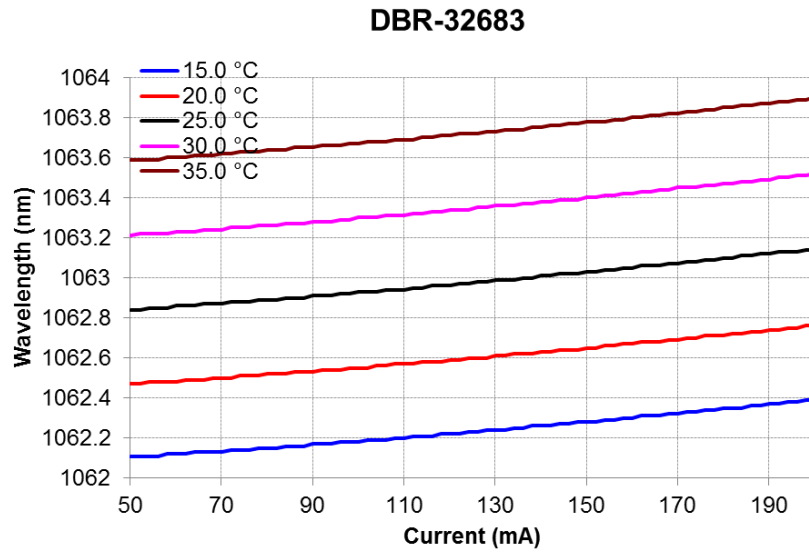

Figure 3: Wavelength versus Bias Current

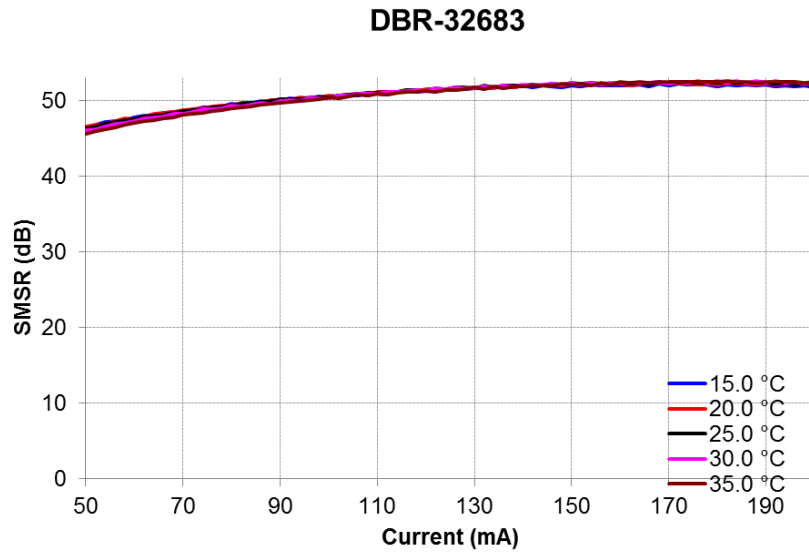

Figure 4: Side Mode Suppression Ratio (SMSR) versus Bias Current

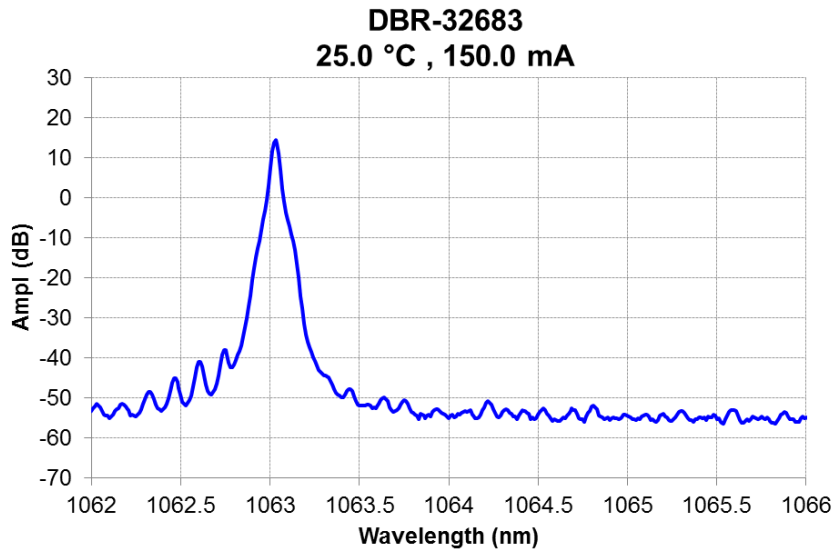

Figure 5: Optical Spectrum (RBW=0.02nm)

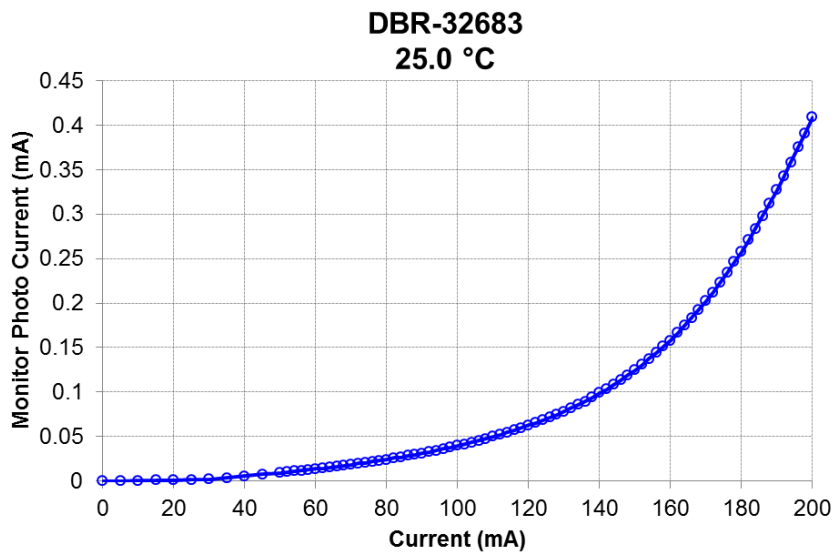

Figure 6: Monitor Photodiode Current versus Bias Current