

# C SERIES

The C series are general purpose medium size connectors. They fit the same size cables as the 'N' series. They compliment the 'N' series by offering the same size fitting for the same cables except the 'C' series has a bayonet coupling mechanism. They are also weatherproof and built to withstand rugged environments.

<b>MATERIALS:</b>	Brass per QQ-B-626 composition 22½ HD. Beryllium copper per QQ-C-530 heat treated to condition HT. Teflon per L-P-503 Rubber per ZZ-R-765
<b>FINISHES:</b>	Silver plating per QQ-S-365 Gold plating per MIL-G-45204 Proprietary bright nickel (IP23)
<b>ELECTRICAL:</b>	Impedance 50 ohms Frequency range: DC to 12 GHz Insulation resistance: 5000 Megohms Voltage rating: 1000 VRMS Contact resistance: Center 1.0 MILLIOHMS max. Outer .15 MILLIOHMS max. silver and gold only
<b>ENVIRONMENTAL:</b>	Temperature range: -65° to + 165°C Salt spray test per MIL-STD-202 (Method 101) Moisture resistance test per MIL-STD-202 (Method 106)

# C SERIES

## C PLUG

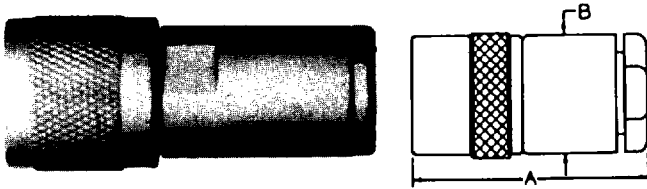

S/C Part No.	UG-U No.	Cable RG-U	Dimension		Engr. Data	Assy. Inst.
			A	B		
27P100-1	UG-5738/U	8,8A,9 9A,213, 214	1-31/64	3/4		
27P108-3		8,213	1-1/2	3/4	Straight Cut Style	AI-81
27P108-5		9,214	1-1/2	3/4	Straight Cut Style	AI-81
27P110-2		58	1-3/8	1/2	Straight Cut Style	AI-12
27P110-3		122	1-3/8	1/2	Straight Cut Style	AI-12
27P110-4		303	1-3/8	1/2	Straight Cut Style	AI-12
27P110-5		59	1-3/8	1/2	Straight Cut Style	AI-12

## C PLUG RIGHT ANGLE

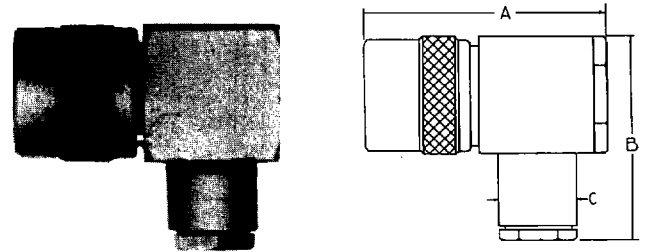

S/C Part No.	Cable RG-U	Dimension			Engr. Data	Assy. Inst.
		A	B	C		
27P106-1	58,223	1-9/16	1-1/4	1/2		
27P106-2	59,62	1-9/16	1-1/4	1/2		
27P113-1	58	1-35/64	1-1/4	1/2	Straight Cut Style	AI-19

## C PLUG RIGHT ANGLE

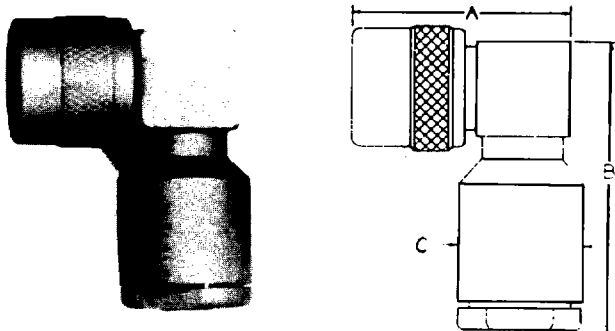

S/C Part No.	UG-U No.	Cable RG-U	Dimension			Engr. Data	Assy. Inst.
			A	B	C		
27P101-1	UG-710B/U	8,9,213 214	1-1/4	1-15/32	3/4		
27P112-1		8,213	1-1/4	1-19/32	3/4	Straight Cut Style	AI-81
27P112-3		9,214	1-1/4	1-19/32	3/4	Straight Cut Style	AI-81
27P119-1		8,9,213 214	1-1/4	1-19/32	3/4	Captive Contact	AI-71

## C PLUG — RIGHT ANGLE

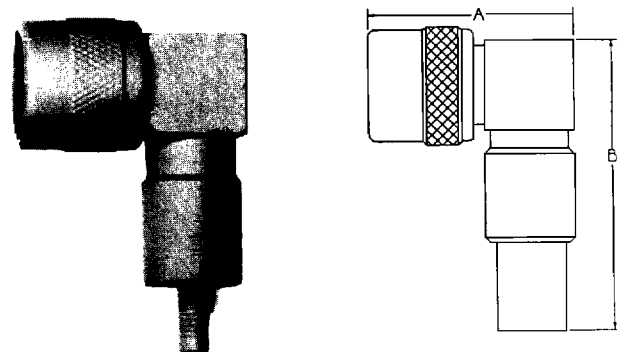

S/C Part No.	Cable RG-U	Crimp Tool	Dimension		Engr. Data
			A	B	
27P122-1	8,213	.429 HEX	1-1/4	2-3/32	Crimp Captive Contact
27P122-2	9,214	.429 HEX	1-1/4	2-3/32	Crimp Captive Contact
27P122-3	58	.213 HEX	1-1/4	2"	Crimp Captive Contact

## C PLUG — CRIMP ON

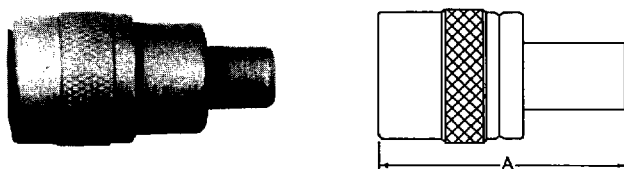

S/C Part No.	Cable RG-U	Crimp Tool	Dimension	Engr. Data
			A	
27P120-1	8,213	.429 HEX	1-43/64	Crimp Captive Contact
27P120-2	9,214	.429 HEX	1-43/64	Crimp Captive Contact
27P120-3	58	.213 HEX	1-9/16	Crimp Captive Contact

## C JACK

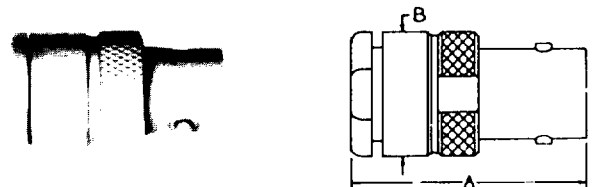

S/C Part No.	UG-U No.	Cable RG-U	Dimension		Engr. Data	Assy. Inst.
			A	B		
27J101-1	UG-572/U	8,9	1-11/32	3/4		
27J102-1	UG-633/U	5,6	1-11/32	3/4		
27J105-2		58	1-1/4	1/2	Straight Cut Style	AI-12
27J105-4		303	1-1/4	1/2	Straight Cut Style	AI-12
27J105-5		59	1-1/4	1/2	Straight Cut Style	AI-12
27J106-1		5,212	1-23/64	3/4	Straight Cut Style	AI-81
27J106-4		9,214	1-23/64	3/4	Straight Cut Style	AI-81

# C SERIES

## C JACK — SINGLE HOLE MOUNT

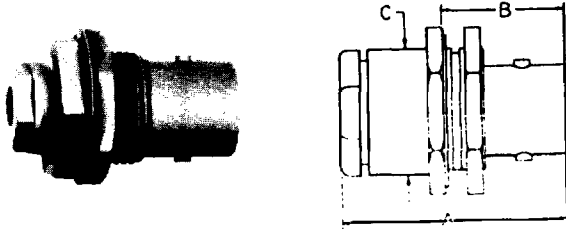

S/C Part No.	UG-/U No.	Cable RG-/U	Dimension			Mtg. Hole	Engr. Data	Assy. Inst.
			A	B	C			
27JS100-1	UG-570/U	55,58	1-11/32	3/4	3/4	D2		Al-12
27JS102-1		8,9	1-11/32	3/4	3/4	D2		
27JS103-1		5,6	1-11/32	3/4	3/4	D2		
27JS104-1	UG-630/U	174,316	1-43/64	3/4	1/2	D2	Herm. Sealed - Str. Cut Style	Al-12
27JS104-2		58	1-43/64	3/4	1/2	D2	Herm. Sealed - Str. Cut Style	
27JS111-1		59	1-1/4	7/8	1/2	D3	Str. Cut Style	Al-12
27JS112-2		8,213	1-23/64	3/4	3/4	D2	Str. Cut Style	Al-81
27JS112-4		9,214	1-23/64	3/4	3/4	D2	Str. Cut Style	Al-81
27JS116-1		58	1-1/4	7/8	1/2	D3	Str. Cut Style	Al-12
27JS121-1		58,223	1-1/4	7/8	1/2	D3	Captive Contact	

## C JACK — FLANGE MOUNT

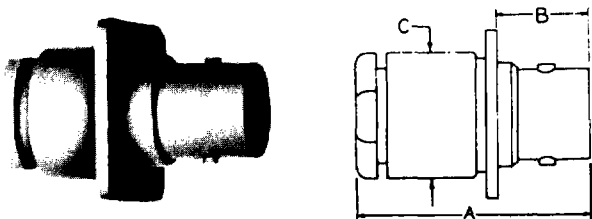

S/C Part No.	UG-/U No.	Cable RG-/U	Dimension			Mtg. Plate	Engr. Data
			A	B	C		
27JF100-1	UG-571/U	8,9	1-11/32	11/16	3/4	1B	Captive Contact
27JF101-1	UG-629/U	5,6	1-11/32	11/16	3/4	1B	
27JF103-1		58,223	1-13/64	11/16	1/2	1A	

## C JACK — CRIMP ON

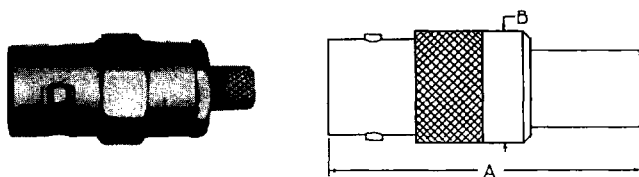

S/C Part No.	Cable RG-/U	Crimp Tool	Dimension		Engr. Data
			A	B	
27J107-1	8,213	.429 HEX	1-3/4	5/8	Crimp Captive Contact

## C JACK — SINGLE HOLE MOUNT — CRIMP ON

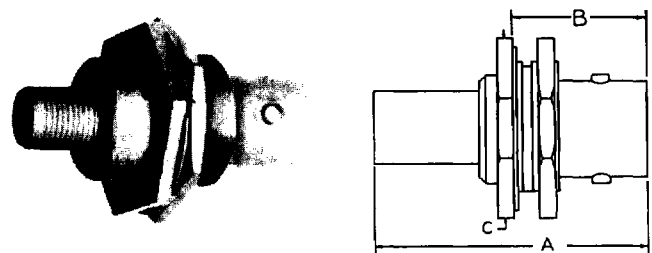

S/C Part No.	Cable RG-/U	Crimp Tool	Dimension			Mtg. Hole	Engr. Data	Assy. Inst.
			A	B	C			
27JS114-1	58	.213 HEX	1-19/32	7/8	3/4	D3	Captive Contact	Al-37
27JS115-1	223	.213 HEX	1-27/64	19/32	3/4	D3	Reverse Mount	
27JS125-1	8,213	.429 HEX	1-13/16	57/64	1"	D2	Crimp Cap. Contact	
27JS125-2	9,214	.429 HEX	1-13/16	57/64	1"	D2	Crimp Cap. Contact	

## C JACK RECEPTACLE — SINGLE HOLE MOUNT

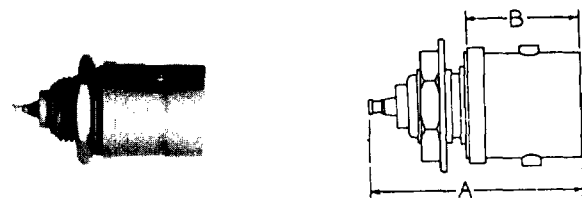

S/C Part No.	UG-/U No.	Dimension		Mtg. Hole	Engr. Data
		A	B		
27JR101-1	UG-706A/U	1-3/32	37/64	D7	Herm. Sealed
27JR102-1	UG-706B/U	1-3/32	37/64	D8	
27JR111-2		1-9/64	37/64	D8	

## C JACK RECEPTACLE — SINGLE HOLE MOUNT

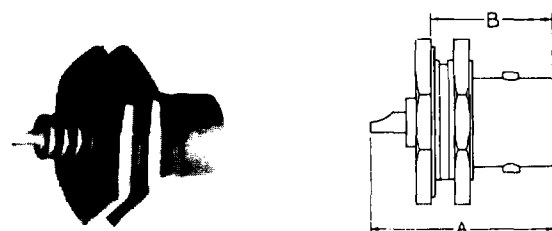

S/C Part No.	UG-/U No.	Dimension		Mtg. Hole	Engr. Data
		A	B		
27JR100-1	UG-634/U	1-5/16	3/4	D2	High Voltage
27JR103-1	UG-569/U	1-3/32	3/4	D2	No Gasket
27JR109-1		1-5/16	1	D2	No Gasket

# C SERIES

## C ADAPTER RIGHT ANGLE

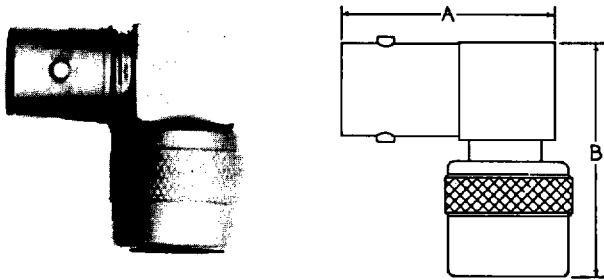

S/C Part No.	UG-/U No.	Adapter Ends	Dimension		Engr. Data
			A	B	
27AR100-1	UG-567A/U	Plug-Jack	1-1/4	1-1/4	

## C ADAPTER RIGHT ANGLE

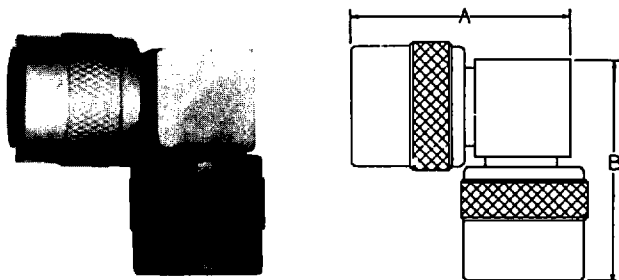

S/C Part No.	UG-/U No.	Adapter Ends	Dimension		Engr. Data
			A	B	
27AR101-1		Plug-Plug	1-1/4	1-1/4	

## C ADAPTER TEE

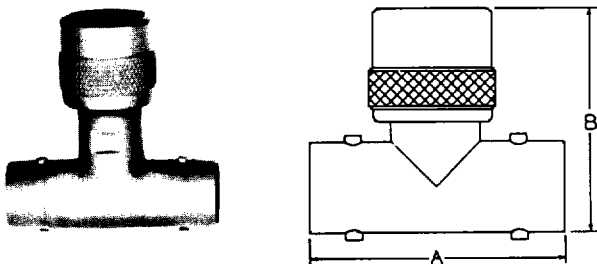

S/C Part No.	UG-/U No.	Adapter Ends	Dimension		Engr. Data
			A	B	
27AT100-1	UG-566A/U	Jack-Plug-Jack	1-33/64	1-21/64	

## C ADAPTER — JACK-JACK — SINGLE HOLE MOUNT

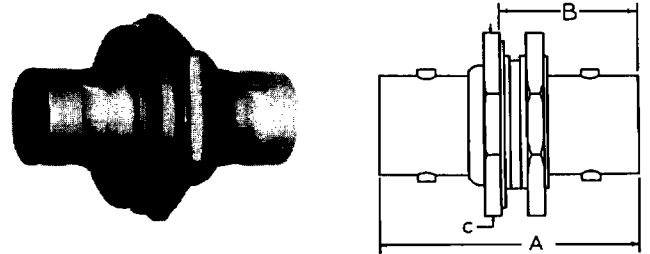

S/C Part No.	UG-/U No.	Dimension			Mtg. Hole	Engr. Data
		A	B	C		
27AS100-1	UG-1138A/U	1-1/2	55/64	1"	D2	Herm. Seal

## C JACK RECEPTACLE — FLANGE MOUNT

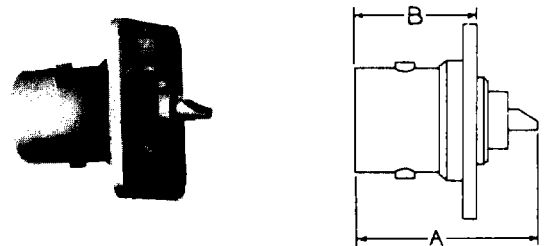

S/C Part No.	UG-/U No.	Dimension		Mtg. Hole	Engr. Data
		A	B		
27JR104-1	UG-568/U	1-3/32	3/4	1B	
27JR104-4		1-3/32	3/4	1A	

## C ADAPTER

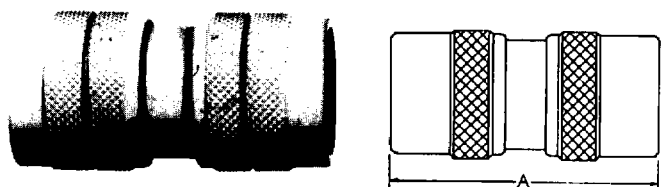

S/C Part No.	UG-/U No.	Adapter Ends	Dimension	Engr. Data
			A	
27A100-1	UG-642A/U	Plug-Plug	1-29/64	

# C SERIES

## C ADAPTER

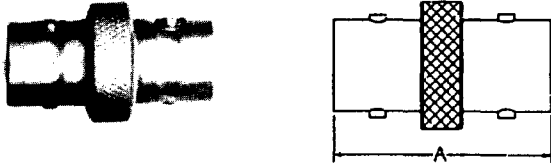

S/C Part No.	UG-/U No.	Adapter Ends	Dimension		Engr. Data
			A		
27A101-1	UG-643/U	Jack-Jack	1-9/32		

## C PLUG CAP & CHAIN

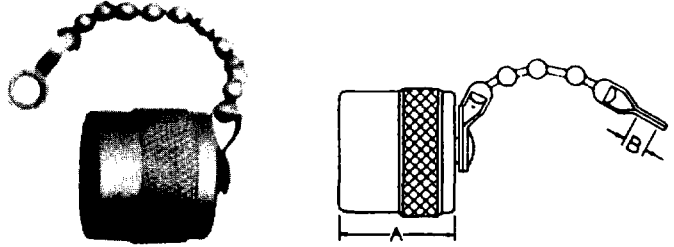

S/C Part No.	Mil Type	Dimension		Engr. Data
		A	B	
27PC100-1	MX-1142/U	11/16	.144	2-1/2" Bead Chain
27PC101-1		7/8		Shorting Cap - No Chain

## C JACK CAP & CHAIN

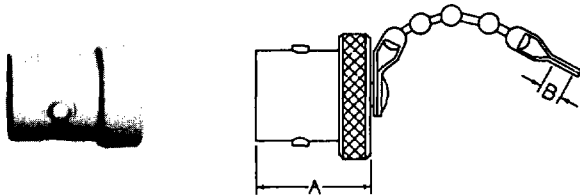

S/C Part No.	Mil Type	Dimension		Engr. Data
		A	B	
27JC100-1	MX-1143A/U	57/64	.144	3" Bead Chain
27JC101-1		3/4		Shorting Cap - No Chain