

**P.C.B. LAYOUT**

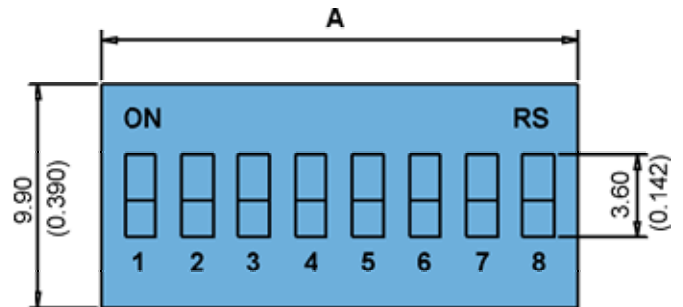

**RS & RSR CONSTRUCTION**

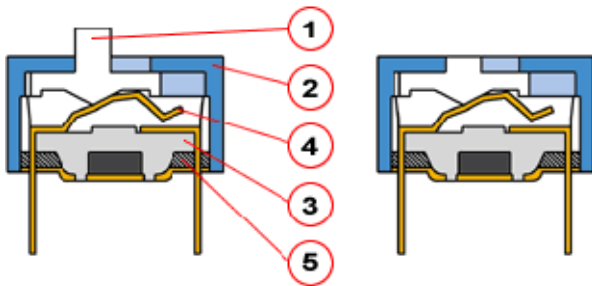

**RS series**

**RSR series**

1. Terminal plating by gold gives excellent results when soldering.
2. RS series (raised actuator) and RSR series (recessed actuator)
3. Low contact resistance, and self-clean on contact area.
4. Double contacts offer high reliability.
5. All materials are UL94V-0 grade fire retardant plastics.

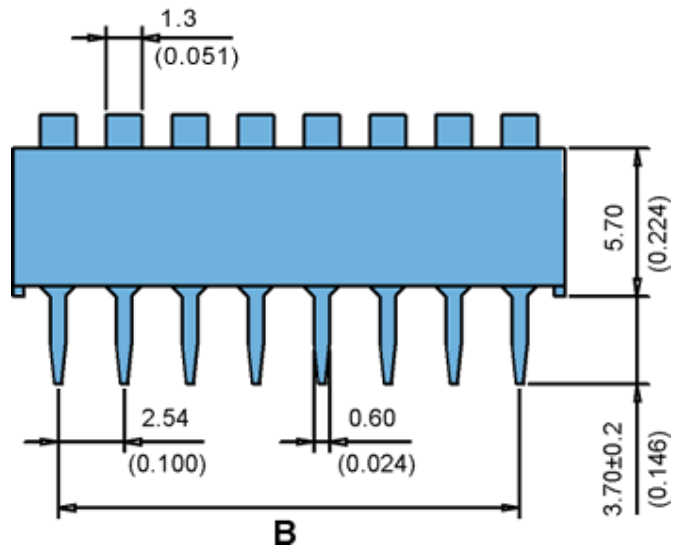

ITEM	Description	Materials	Treatment
1	Actuator	UL94V-0 PBT	White
2	Cover	UL94V-0 PBT	Blue, Red, Black
3	Base	UL94V-0 PBT	Black
4	Terminal	Phosphor bronze	Gold Plating
5	Potting	Epoxy	Black



# DB LECTRO

## MODEL

PROD NO.	NO. OF POS	DIM A	
RSR/RS-01	01	3.84	0.151
RSR/RS-02	02	6.08	0.239
RSR/RS-03	03	8.92	0.315
RSR/RS-04	04	11.16	0.439
RSR/RS-05	05	13.70	0.539
RSR/RS-06	06	16.24	0.639
RSR/RS-07	07	19.08	0.751
RSR/RS-08	08	21.32	0.839
RSR/RS-09	09	24.16	0.951
RSR/RS-10	10	26.40	1.039
RSR/RS-12	12	31.48	1.239

## HOW TO ORDER

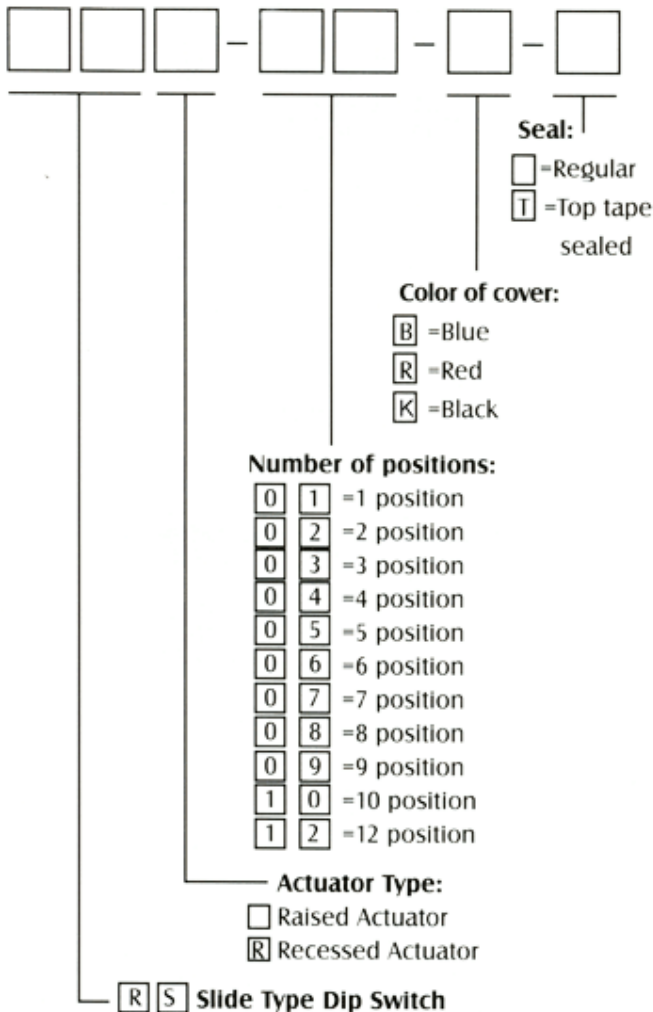

**Example:** RS-08-B-T is a slide type dip switch, raised actuator, 8 position with top tape sealed.

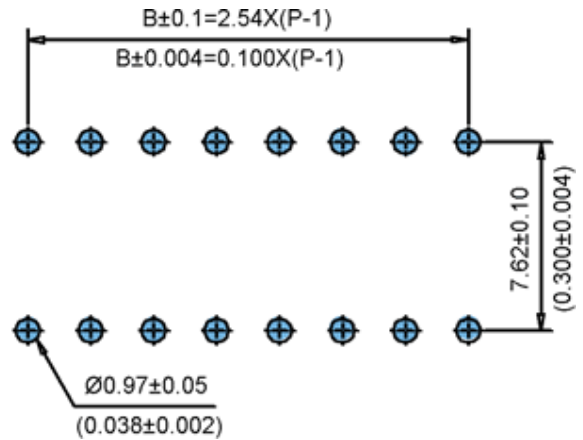

## CIRCUIT DIAGRAM

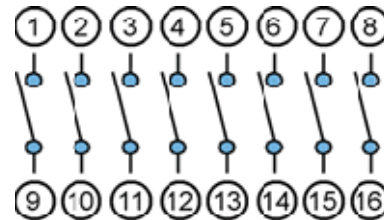

## TERMINAL TYPE

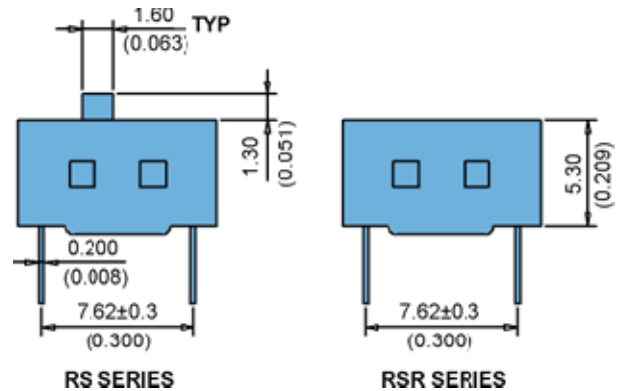

## SPECIFICATION

### ELECTRICAL

Electrical life: 2000 operation cycles per switch 24VDC, 25mA.  
 Non-Switching Rating: 100mA, 50 VDC  
 Switching Rating: 25mA, 24VDC.  
 Contact resistance: (a) 50mΩ max. at initial  
 (b) 100mΩ max. after life test.  
 Insulation resistance: 100MΩ min. (at 500VDC)  
 Dielectric Strength: 500VAC/1 minute.  
 Capacitance: 5pF max.  
 Circuit: Single pole single throw.

### MECHANICAL

Mechanical life: 2000 operations per cycle switch  
 Operation Force: 800gf max.  
 Stroke: 2.0mm  
 Operation Temp: -25° C to +70° C  
 Storage Temp: -40° C to +85° C

# DB LECTRO

**PACKING** All Dip Switches are shipped in standard IC tubes with all poles in "OFF" position.

Vibration Test: MIL-STD-202F METHOD 201A  
Frequency: 10-55-10Hz/1 min  
Directions: X, Y, Z, three mutually perpendicular directions.  
Time: 2 hours each direction.  
High reliability.

Shock Test: MIL-STD-202F METHOD 213B.  
CONDITION A  
GRAVITY: 50G (peak value), 11 m/sec.  
Direction and times: 6 sides and three times in each direction. High reliability.

## **SOLDERING AND CLEANING PROCESSES**

For best results, please follow these recommendations: Keep all switch contacts in their "OFF" position for all operations.

**WAVE SOLDERING:** Recommended solder temperature at 500 F (260° C) max. 5 seconds.

**HAND SOLDERING:** Use a soldering iron of 30 watts, controlled at 608 F(320° C) approximately 2 seconds while applying solder.

**CLEANING PROCESS:** Flux clean using force rinse, high agitation or triple bath cleaning method. Freon TF or TE give excellent results. When vapor methods are used, do not subject the switch to solvents at temperatures above 125 F (51° C).