

**OMNIMATE Signal - series BC/SC 3.81  
SCD 3.81/14/180G 3.2SN BK BX**

**Weidmüller Interface GmbH & Co. KG**  
 Klingenbergstraße 16  
 D-32758 Detmold  
 Germany  
 Fon: +49 5231 14-0  
 Fax: +49 5231 14-292083  
 www.weidmueller.com

**Product image**

Similar to illustration

Two-tier SCD pin header for wave soldering.

- It allows you to use two interfaces on only one surface and with only one step in the work flow.
- Outlet direction: 180° (standing).
- Connections at the same level and with access that is flush over the front board.
- Space for labelling and coding
- Packed in cardboard box.

Weidmüller's 3.81-mm-pitch (0.15 inch) plug-in connectors are compatible with the layouts of standard connectors and offer space for labelling and coding.

**General ordering data**

Delivery status	<b>Discontinued</b>
Available until	2014-05-20
Type	SCD 3.81/14/180G 3.2SN BK BX
Order No.	<a href="#">1030320000</a>
Version	PCB plug-in connector, male header, closed side, THT solder connection, 3.81 mm, No. of poles: 14, 180°, Solder pin length (l): 3.2 mm, tinned, black, Box
GTIN (EAN)	4032248759484
Qty.	50 pc(s).
Product data	IEC: 320 V / 17.5 A UL: 300 V / 10 A
Packaging	Box

**OMNIMATE Signal - series BC/SC 3.81  
SCD 3.81/14/180G 3.2SN BK BX**

**Weidmüller Interface GmbH & Co. KG**  
Klingenbergstraße 16  
D-32758 Detmold  
Germany  
Fon: +49 5231 14-0  
Fax: +49 5231 14-292083  
www.weidmueller.com

**Technical data****Dimensions and weights**

Width	28.06 mm	Width (inches)	1.105 inch
Height	25.1 mm	Height (inches)	0.988 inch
Height of lowest version	21.9 mm	Depth	22.7 mm
Depth (inches)	0.894 inch	Net weight	10.315 g

**System specifications**

Product family	OMNIMATE Signal - series BC/SC 3.81	Type of connection	Board connection
Mounting onto the PCB	THT solder connection	Pitch in mm (P)	3.81 mm
Pitch in inches (P)	0.15 inch	Outgoing elbow	180°
No. of poles	14	Number of solder pins per pole	1
Solder pin length (l)	3.2 mm	Solder pin length tolerance	+0,02 / -0,02 mm
Tolerance of solder pin position	± 0.1 mm	Solder pin dimensions	d = 1.0 mm, Octagonal
Solder pin dimensions = d tolerance	0 / -0,03 mm	Solder eyelet hole diameter (D)	1.2 mm
Solder eyelet hole diameter tolerance (D)+	0,1 mm	L1 in mm	22.86 mm
L1 in inches	0.9 inch	Number of rows	2
Pin series quantity	2	Touch-safe protection acc. to DIN VDE 57 106	Safe from finger touch
Touch-safe protection acc. to DIN VDE 0470	IP 20	Volume resistance	6.00 mΩ
Can be coded	Yes	Plugging cycles	25
Plugging force/pole, max.	8 N	Pulling force/pole, max.	5.5 N

**Material data**

Insulating material	PA GF	Colour	black
Colour chart (similar)	RAL 9011	Insulating material group	II
CTI	≥ 550	Insulation strength	≥ 10 <sup>8</sup> Ω
UL 94 flammability rating	V-0	GWFI	960 °C
Contact material	Copper alloy	Contact surface	tinned
Storage temperature, min.	-25 °C	Storage temperature, max.	55 °C
Max. relative humidity during storage	80 %	Operating temperature, min.	-50 °C
Operating temperature, max.	120 °C	Temperature range, installation, min.	-25 °C
Temperature range, installation, max.	120 °C		

**Rated data acc. to IEC**

tested acc. to standard	IEC 60664-1, IEC 61984	Rated current, min. no. of poles (Tu=20°C)	17.5 A
Rated current, min. no. of poles (Tu=40°C)	17 A	Rated voltage for surge voltage class / pollution degree II/2	320 V
Rated voltage for surge voltage class / pollution degree III/2	160 V	Rated voltage for surge voltage class / pollution degree III/3	160 V
Rated impulse voltage for surge voltage class/ pollution degree II/2	2.5 kV	Rated impulse voltage for surge voltage class/ pollution degree III/2	2.5 kV
Rated impulse voltage for surge voltage class/ contamination degree III/3	2.5 kV	Short-time withstand current resistance	3 x 1s with 76 A

**Rated data acc. to CSA**

Rated voltage (Use group B / CSA)	300 V	Rated current (Use group B / CSA)	11 A
-----------------------------------	-------	-----------------------------------	------

## OMNIMATE Signal - series BC/SC 3.81 SCD 3.81/14/180G 3.2SN BK BX

**Weidmüller Interface GmbH & Co. KG**  
Klingenbergstraße 16  
D-32758 Detmold  
Germany  
Fon: +49 5231 14-0  
Fax: +49 5231 14-292083  
www.weidmueller.com

## Technical data

### Rated data acc. to UL 1059

Institute (cURus)



Certificate No. (cURus)

E60693

Rated voltage (Use group B / UL 1059) 300 V

Rated voltage (Use group D / UL 1059) 300 V

Rated current (Use group B / UL 1059) 10 A

Rated current (Use group D / UL 1059) 10 A

Reference to approval values

Specifications are maximum values, details - see approval certificate.

### Packing

Packaging Box  
VPE width 0

VPE length 0  
VPE height 0

### Classifications

ETIM 4.0 EC002637  
eClass 6.2 27-26-07-04  
eClass 8.1 27-44-04-02

ETIM 5.0 EC002637  
eClass 7.1 27-44-04-02

### Notes

Notes

- Additional colours on request
- Rated current related to rated cross-section & min. No. of poles.
- Rated data refer only to the component itself. Clearance and creepage distances to other components are to be designed in accordance with the relevant application standards.
- P on drawing = pitch

IPC conformity

Conformity: The products are developed, manufactured and delivered according international recognized standards and norms and comply with the assured properties in the data sheet resp. fulfill decorative properties in accordance with IPC-A-610 "Class 2". Further claims on the products can be evaluated on request.

### Approvals

Approvals



ROHS

Conform

### Downloads

Approval/Certificate/Document of Conformity

[Declaration of the Manufacturer](#)

Brochure/Catalogue

[CAT 2 PORTFOLIOGUIDE EN](#)

**OMNIMATE Signal - series BC/SC 3.81  
SCD 3.81/14/180G 3.2SN BK BX**

**Weidmüller Interface GmbH & Co. KG**  
Klingenbergstraße 16  
D-32758 Detmold  
Germany  
Fon: +49 5231 14-0  
Fax: +49 5231 14-292083  
www.weidmueller.com

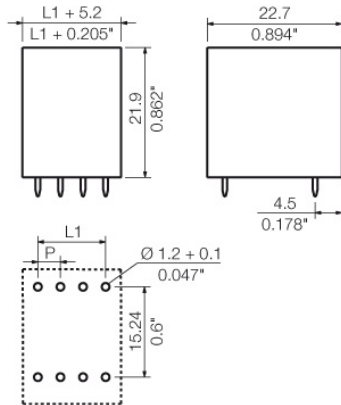
**Drawings****Dimensional drawing**

04

SCD 3.81/.../180G 3.2...

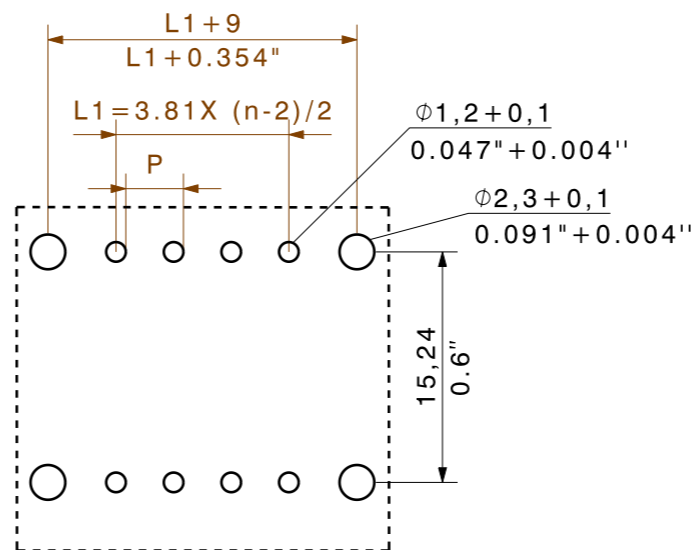
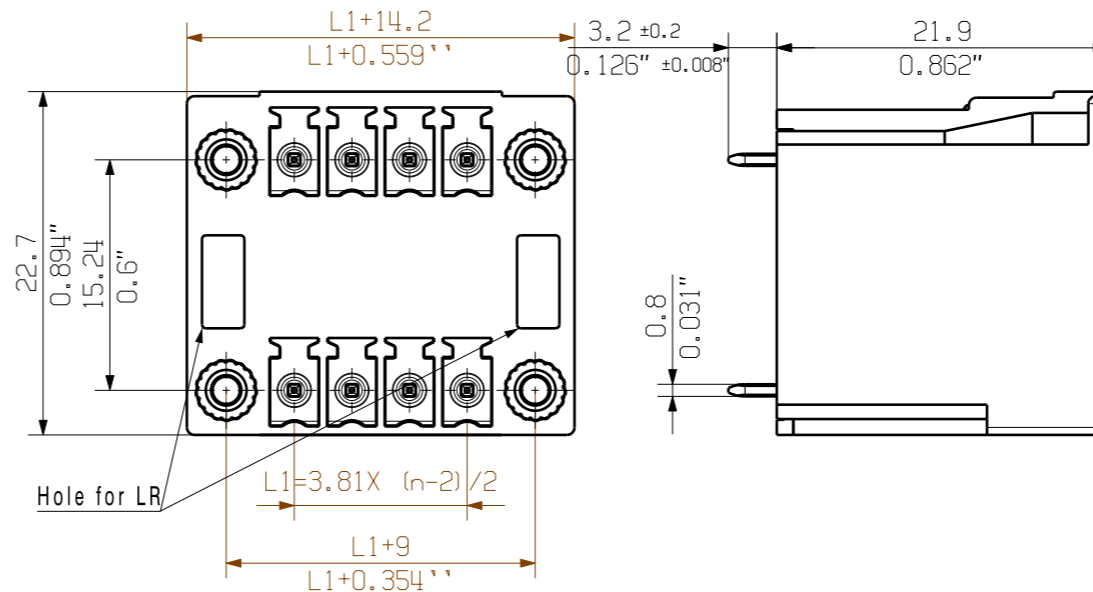
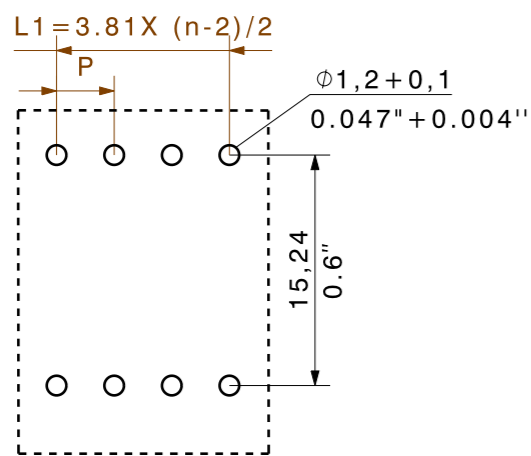
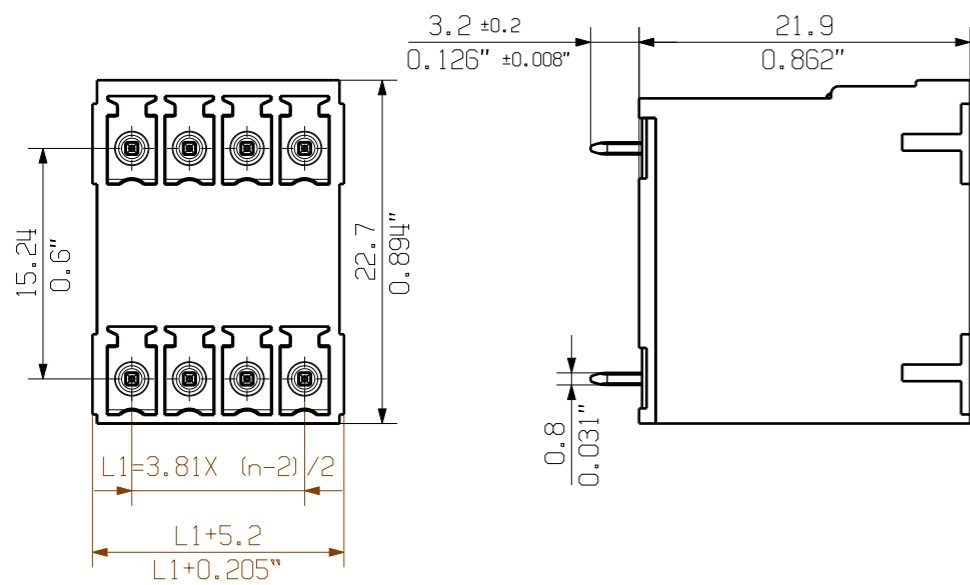

SCD 3.81/.../180F 3.2...  
WITH  
BCF 3.81/.../180 LR

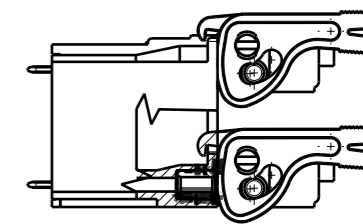

SCD 3.81/.../180F 3.2...  
WITH  
BCF 3.81/.../180 LR  
M 1/1

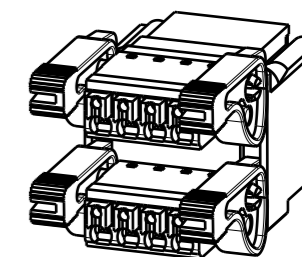

NOTE:

n=NO OF POLES  
P=PITCH

KUNDENZEICHNUNG  
CUSTOMER DRAWING

For the mounting of PCBs, it should be noted that the rated data stated here relates only to the PCB components alone.  
The necessary creepage and clearance paths must be observed in connection with the respective applicant in accordance to IEC 664 / VDE 0110.  
The current-carrying capacity and pitch tolerance is to be determined according to DIN IEC 326 part 3 very fine.

Weidmüller PCB components are tested to the DIN EN 61984 standard, and are valid for its field of application. Provided that the components are used to the intended purpose, all requirements with respect to the occurring of electrical, mechanical, thermic and corrosive stress will be satisfied.

16	57.15	2.250
15	53.34	2.100
14	49.53	1.950
13	45.72	1.800
12	41.91	1.650
11	38.10	1.500
10	34.29	1.350
9	30.48	1.200
8	26.67	1.050
7	22.86	0.900
6	19.05	0.750
5	15.24	0.600
4	11.43	0.450
3	7.62	0.300
2	3.81	0.150
n	L1 [mm]	L1 [inch]

<b>GENERAL TOLERANCE:</b> DIN ISO 2768-m		99958/4 06.03.18 MA_J 01		Cat.no.:	
RoHS COMPLIANT	Max. nos.	Modification		<b>Weidmüller</b>	
Scale: 5/1		Drawn	Date	Name	Drawing no. <b>C 46286</b> 04
Supersedes:		Responsible	Checked	Approved	Issue no.
Product file: SCD 3.81		SCD... 3.81/.../180... THR-LOETANSCHLUSS STIFTLISTE THR SOLDER CONNECTION PIN HEADER		Sheet 01 of 02 sheets	
7079					

The reproduction, distribution and utilization of this document as well as the communication of its contents to others without explicit authorization is prohibited. Offenders will be held liable for the payment of damages. Weidmüller exclusively reserves the right to file for patents, utility models or designs.

© Weidmüller Interface GmbH & Co. KG

## Recommended wave soldering profiles

**Weidmüller Interface GmbH & Co. KG**  
 Klängenbergstraße 16  
 D-32758 Detmold  
 Germany  
 Fon: +49 5231 14-0  
 Fax: +49 5231 14-292083  
 www.weidmueller.com

### Single Wave:



### Double Wave:



### Wave soldering profiles

Wired connection elements should be processed in accordance with the DIN EN 61760-1 standard. We have included two recommendations for practical wave soldering profiles, with which Weidmüller PCB terminals and connectors are qualified.

When choosing a suitable profile for your application, the following factors also need to be considered:

- PCB thickness
- Proportion of Cu in the layers
- Single/double-sided assembly
- Product range
- Heating and cooling rates

The single and double wave profiles each indicate the recommended operating range, including the maximum soldering temperature of 260°C. In practice, the maximum soldering temperature is quite often well below the above maximum profile.