



SFH636

High Speed 5.3 kV Optocoupler

FEATURES

- High Speed Optocoupler without Base Connection
- GaAlAs Emitter
- Integrated Detector with Photodiode and Transistor
- High Data Transmission Rate: 1.0 MBit/s
- TTL Compatible
- Open Collector Output
- CTR at $I_F=16\text{ mA}$, $V_O=0.4\text{ V}$, $V_{CC}=4.5\text{ V}$, $T_A=25^\circ\text{C}$: $\geq 19\%$
- Good CTR Linearity Relative to Forward Current
- Field Effect Stable by TRIOS[®] (Transparent Ion Shield)
- Low Coupling Capacitance
- dV/dt : typ. 10 kV/ μs
- Isolation Test Voltage: 5300 V_{RMS}
- UL Approval, File #E52744
- VDE #0884, Available with Option 1

APPLICATIONS

- IGBT Drivers
- Data Communications
- Programmable Controllers

DESCRIPTION

The SFH636 is an optocoupler with a GaAlAs infrared emitting diode, optically coupled to an integrated photodetector consisting of a photodiode and a high speed transistor in a DIP-6 plastic package. The device is functionally similar to 6N136 except there is no base connection, and the electrical foot print is different. Noise and dV/dt performance is enhanced by not bringing out the base connection.

Signals can be transmitted between two electrically separated circuits up to frequencies of 2.0 MHz. The potential difference between the circuits to be coupled should not exceed the maximum permissible reference voltages.

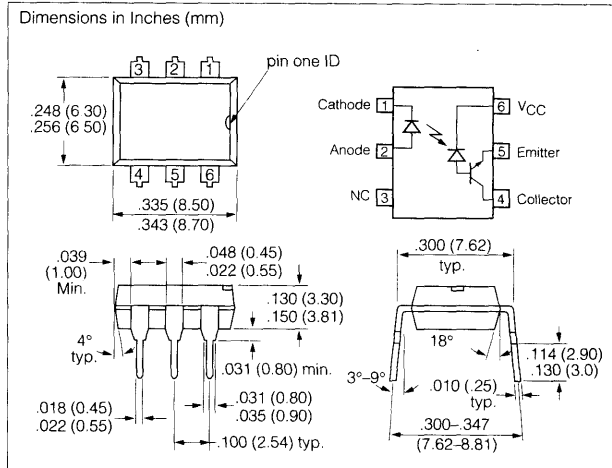

Optocouplers

Absolute Maximum Ratings

Emitter (GaAlAs)

Reverse Voltage.....	3.0 V
DC Forward Current.....	25 mA
Surge Forward Current.....	1.0 A
$t_p \leq 1.0\ \mu\text{s}$, 300 pulses/s	
Total Power Dissipation.....	45 mW

Detector (Si Photodiode + Transistor)

Supply Voltage.....	-0.5 to 30 V
Output Voltage.....	-0.5 to 20 V
Output Current.....	8.0 mA
Total Power Dissipation.....	100 mW

Package Insulation

Isolation Test Voltage	
between emitter and detector	
(refer to climate DIN 40046 part 2, Nov. 74)	5300 V_{RMS}
Creepage.....	$\geq 7.0\text{ mm}$
Clearance.....	$\geq 7.0\text{ mm}$
Isolation Resistance	
$V_{IO}=500\text{ V}$, $T_A=25^\circ\text{C}$	$\geq 10^{12}\ \Omega$
$V_{IO}=500\text{ V}$, $T_A=100^\circ\text{C}$	$\geq 10^{11}\ \Omega$
Storage Temperature Range	-55 to +150°C
Ambient Temperature Range.....	-55 to +100°C
Junction Temperature.....	100°C
Soldering Temperature (t=10 s max.)	
Dip soldering: distance to seating plane $\geq 1.5\text{ mm}$	260°C

Characteristics ($T_A=0^\circ$ to 70°C , unless otherwise specified, typical values $T_A=25^\circ\text{C}$)

Description	Symbol	Min.	Typ.	Max.	Unit	Condition
Emitter (IR GaAlAs)						
Forward Voltage	V_F	—	1.5	1.8	V	$I_F=16\text{ mA}$
Reverse Current	I_R	—	0.5	10	μA	$V_R=3.0\text{ V}$
Capacitance	C_0	—	125	—	pF	$V_R=0\text{ V}$, $f=1.0\text{ MHz}$
Thermal Resistance	R_{thJA}	—	700	—	$^\circ\text{K/W}$	—
Detector (Si Photodiode + Transistor)						
Supply Current, Logic High	I_{CCH}	—	0.01	1.0	μA	$I_F=0$, V_O (open), $V_{CC}=15\text{ V}$, $T_A=25^\circ\text{C}$
		—	0.01	2.0		$I_F=0$, V_O (open), $V_{CC}=15\text{ V}$
Output Current, Output High	I_{OH}	—	.003	0.5	μA	$I_F=0$, V_O (open), $V_{CC}=5.5\text{ V}$, $T_A=25^\circ\text{C}$
		—	.01	1.0		$I_F=0$, V_O (open), $V_{CC}=15\text{ V}$, $T_A=25^\circ\text{C}$
		—	—	50		$I_F=0$, V_O (open), $V_{CC}=15\text{ V}$
		—	—	—		$I_F=0$, V_O (open), $V_{CC}=15\text{ V}$
Capacitance	C_{CE}	—	3.0	—	pF	$V_{CE}=5.0\text{ V}$, $f=1.0\text{ MHz}$
Thermal Resistance	R_{thJA}	—	300	—	$^\circ\text{K/W}$	—
Package						
Coupling Capacitance	C_C	—	0.6	—	pF	—
Coupling Transfer Ratio	I_C/I_F	19	30	—	%	$I_F=16\text{ mA}$, $V_O=0.4\text{ V}$, $V_{CC}=4.5\text{ V}$, $T_A=25^\circ\text{C}$
		15	—	—		$I_F=16\text{ mA}$, $V_O=0.5\text{ V}$, $V_{CC}=4.5\text{ V}$
Collector Emitter Saturation Voltage	V_{OL}	—	0.1	0.4	V	$I_F=16\text{ mA}$, $I_O=2.4\text{ mA}$, $V_{CC}=4.5\text{ V}$, $T_A=25^\circ\text{C}$
Supply Current, Logic Low	I_{CCL}	—	80	—	μA	$I_F=16\text{ mA}$, V_O open, $V_{CC}=15\text{ V}$

Figure 1. Test Set-up

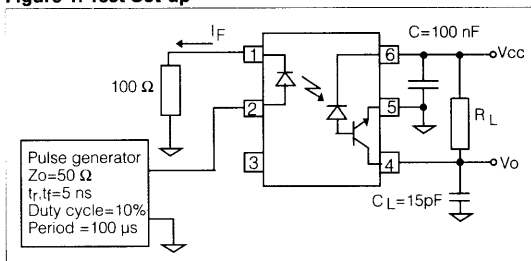
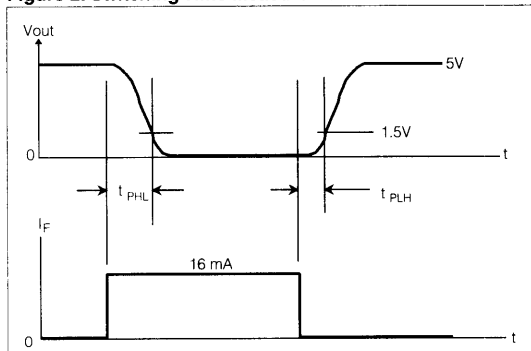

Figure 2. Switching Time Measurement



Description	Sym.	Min.	Typ.	Max.	Unit	Condition
Propagation Delay Time (High-Low)	t_{PHL}	—	0.3	0.8	μs	$I_F=16\text{ mA}$, $V_{CC}=5.0\text{ V}$ $R_L=1.9\text{ k}\Omega$, $T_A=25^\circ\text{C}$
Propagation Delay Time (Low-Low)	t_{PLH}	—	—	—	—	

Figure 3. Common Mode Transient Test

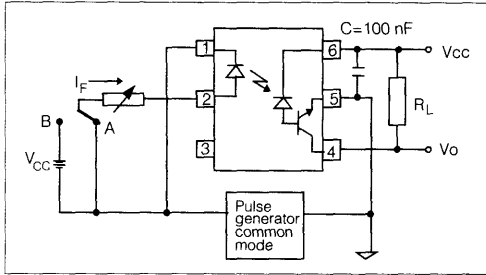
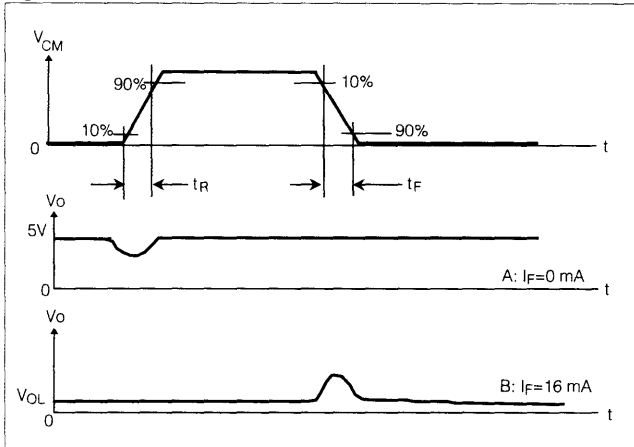

Figure 4. Measurement Waveform of CMR



Description	Sym.	Min.	Typ.	Max.	Unit	Condition
Common Mode Transient Immunity (High)	CM _H	—	10	—	kV/μs	I _F =0, V _{CM} =1500 V _{p.p.} , R _L =1.9 kΩ, V _{CC} =5.0 V, T _A =25°C
Common Mode Transient Immunity (Low)	CM _L	—	10	—	kV/μs	I _F =16 mA, V _{CM} =1500 V _{p.p.} , R _L =1.9 kΩ, V _{CC} =5.0 V, T _A =25°C

Figure 5. Output Characteristics—Output Current vs. Output Voltage
 $T_A=25^\circ\text{C}$, $V_{CC}=5.0\text{ V}$

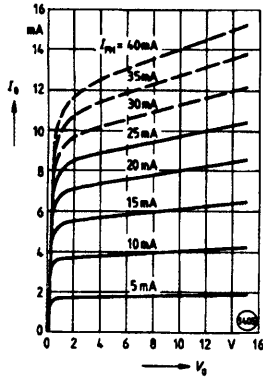

Figure 6. Permissible Forward Current of Emitting Diode vs. Ambient Temperature

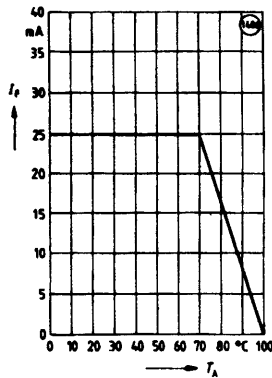

Figure 7. Permissible Total Power Dissipation vs. Ambient Temperature

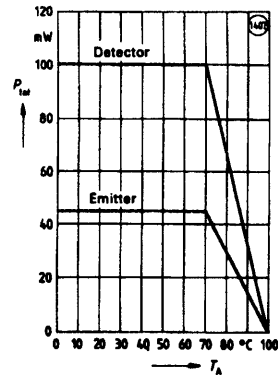

Figure 8. Forward Current of Emitting Diode vs. Forward Voltage
 $T_A=25^\circ\text{C}$

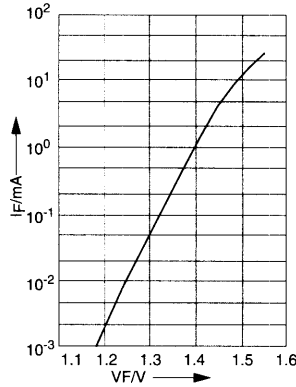

Figure 9. Small Signal Transfer Ratio vs. Forward Current
 $V_{CC}=5.0\text{ V}$, $T_A=25^\circ\text{C}$

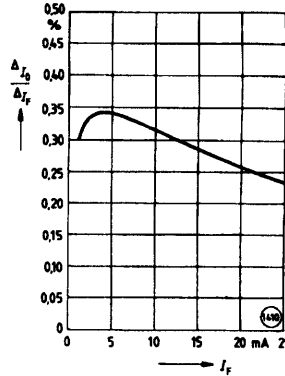

Figure 10. Current Transfer Ratio (normalized) vs. Ambient Temp.
 $I_F=16\text{ mA}$, $V_O=0.4\text{ V}$, $V_{CC}=5.0\text{ V}$, $T_A=25^\circ\text{C}$

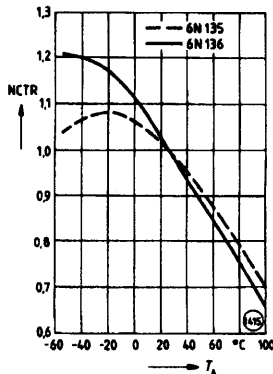

Figure 11. Output Current (high) vs. Ambient Temperature
 $V_O=V_{CC}=5.0\text{ V}$, $I_F=0$

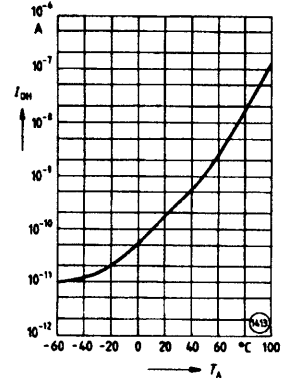

Figure 12. Delay Times vs. Ambient Temperature
 $I_F=16\text{ mA}$, $V_{CC}=5.0\text{ V}$, $R_L=4.1\text{ k}\Omega$, SFH636: $R_L=1.9\text{ k}\Omega$

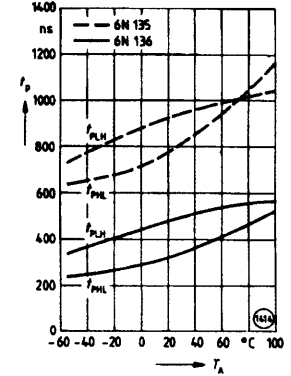

Figure 13. Current Transfer Ratio (normalized) vs. Forward Current
 $I_F=16\text{ mA}$, $V_O=0.4\text{ V}$, $V_{CC}=5.0\text{ V}$, $T_A=25^\circ\text{C}$

