

QUAD ASYNCHRONOUS RECEIVER/TRANSMITTER WITH FIFOS

DESCRIPTION

The ST16C554 is a universal asynchronous receiver and transmitter with 16 byte transmit and receive FIFO. A programmable baud rate generator is provided to select transmit and receive clock rates from 50Hz to 448kHz.

The ST16C554 is an improved version of the NS16C550 UART with higher operating speed and lower access time. The ST16C554 on board status registers provides the error conditions, type and status of the transfer operation being performed. Included is complete MODEM control capability, and a processor interrupt system that may be software tailored to the user's requirements. The ST16C554 provides internal loop-back capability for on board diagnostic testing.

The ST16C554 is fabricated in an advanced 1.2 μ CMOS process to achieve low drain power and high speed requirements.

FEATURES

- Pin to pin and functional compatible to ST16C454
- 16 byte transmit FIFO
- 16 byte receive FIFO with error flags
- Modem control signals (CTS*, RTS*, DSR*, DTR*, RI*, CD*)
- Programmable character lengths (5, 6, 7, 8)
- Even, odd, or no parity bit generation and detection
- Status report register
- Independent transmit and receive control
- TTL compatible inputs, outputs
- Software compatible with INS8250, NS16C550
- 448 kHz transmit/receive operation with 7.372 MHz crystal or external clock source

ORDERING INFORMATION

| Part number | Package | Operating temperature |
|---------------|---------|-----------------------|
| ST16C554CJ68 | PLCC | 0° C to + 70° C |
| ST16C554IJ68 | PLCC | -40° C to + 85° C |
| ST16C554DCJ68 | PLCC | 0° C to + 70° C |
| ST16C554DIJ68 | PLCC | -40° C to + 85° C |

PLCC Package

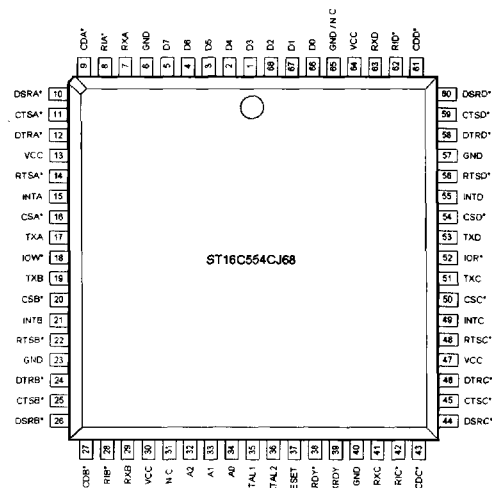
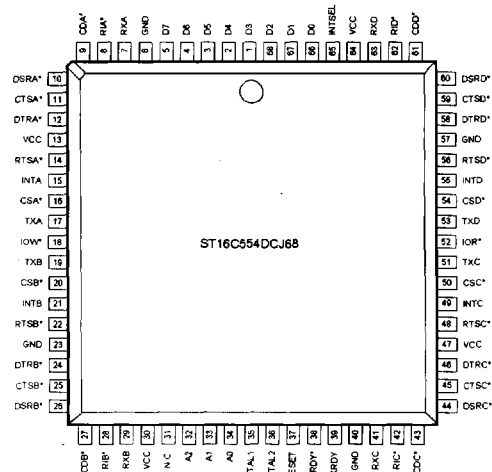

ST16C554 ST16C554D

BLOCK DIAGRAM

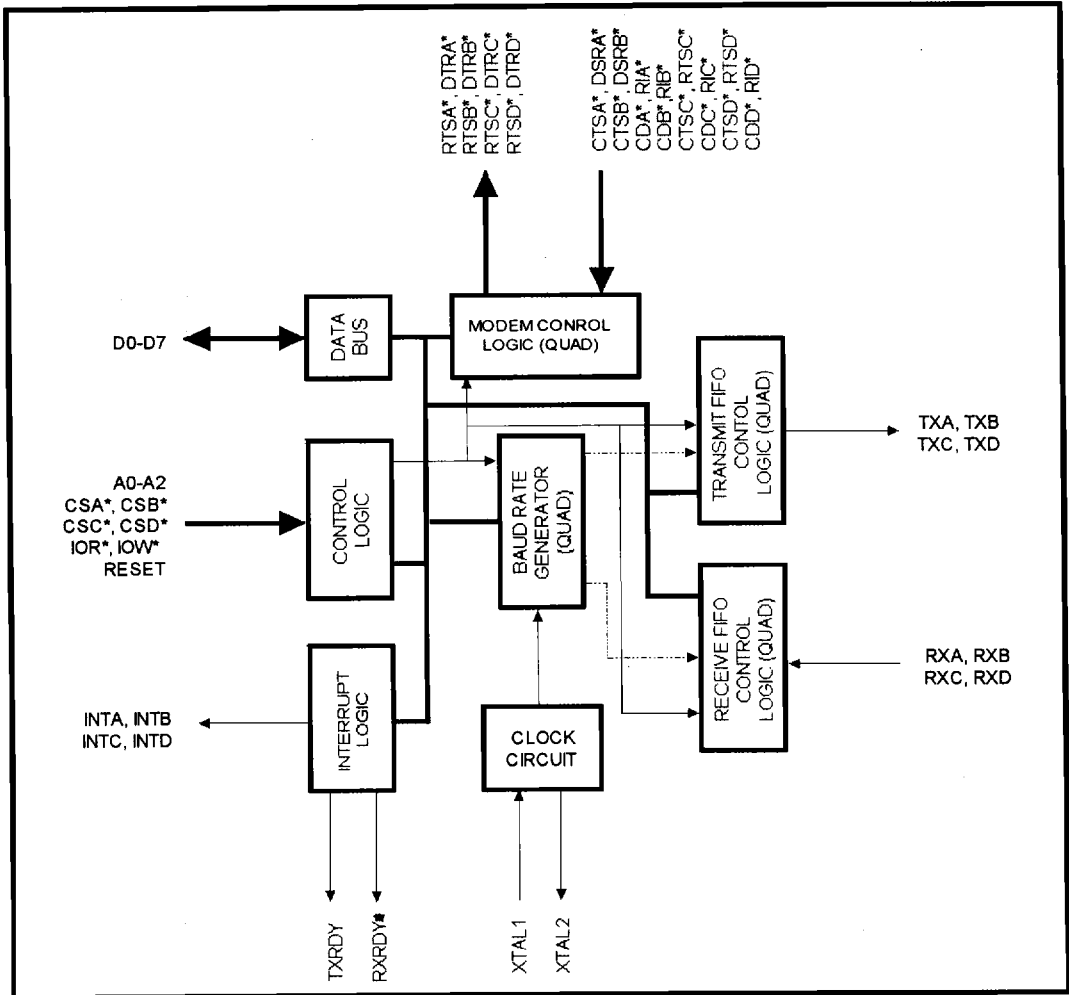

ST16C554

ST16C554D

ST16C554/554D

SYMBOL DESCRIPTION

| Symbol | Pin | Signal Type | Pin Description |
|--------------------|----------------|-------------|---|
| D0-D7 | 5-66 | I/O | Bi-directional data bus. Eight bit, three state data bus to transfer information to or from the CPU. D0 is the least significant bit of the data bus and the first serial data bit to be received or transmitted. |
| RX A-B RX C-D | 7,29 41,63 | I | Serial data input. The serial information (data) received from serial port to ST16C554 receive input circuit. A mark (high) is logic one and a space (low) is logic zero. During the local loopback mode the RX input is disabled from external connection and connected to the TX output internally. |
| TX A-B TX C-D | 17,19 51,53 | O | Serial data output. The serial data is transmitted via this pin with additional start, stop and parity bits. The TX will be held in mark (high) state during reset, local loopback mode or when the transmitter is disabled. |
| CS A-B* CS C-D* | 16,20 50,54 | I | Chip select. (active low) A low at this pin enables the ST16C554 / CPU data transfer operation. Each UART sections of the ST16C554 can be accessed independently. |
| XTAL1 | 35 | I | Crystal input 1 or external clock input. A crystal can be connected to this pin and XTAL2 pin to utilize the internal oscillator circuit. An external clock can be used to clock internal circuit and baud rate generator for custom transmission rates. |
| XTAL2 | 36 | O | Crystal input 2 or buffered clock output. See XTAL1. |
| IOW* | 18 | I | Write strobe. (active low) A low on this pin will transfer the contents of the CPU data bus to the addressed register. |
| GND GND | 6,23 40,57 | O | Signal and power ground. |
| IOR* | 52 | I | Read strobe. (active low) A low level on this pin transfers the contents of the ST16C554 data bus to the CPU. |

ST16C554

ST16C554D

SYMBOL DESCRIPTION

| Symbol | Pin | Signal Type | Pin Description |
|----------------------|----------------|-------------|--|
| TXRDY | 39 | O | Transmit ready. (active high) This pin goes high when the transmit FIFO of the ST16C554 is full. It can be used as a single or multi-transfer. |
| A2 | 32 | I | Address select line 2. To select internal registers. |
| A1 | 33 | I | Address select line 1. To select internal registers. |
| A0 | 34 | I | Address select line 0. To select internal registers. |
| RXRDY* | 38 | O | Receive ready. (active high) This pin goes high when the receive FIFO is full. It can be used as a single or multi-transfer. |
| INTSEL | 65** | I | Interrupt type select. Enable /disable the interrupt three state function. Normal interrupt output can be selected by connecting this pin to VCC (MCR bit-3 does not have any effect on the interrupt output). The three state interrupt output is selected when this pin is left open or connected to GND and MCR bit-3 is set to "1". |
| INT A-B INT C-D | 15,21 49,55 | O | Interrupt output. (active high) This pin goes high (when enabled by the interrupt enable register) whenever a receiver error, receiver data available, transmitter empty, or modem status condition flag is detected. |
| RTS A-B* RTS C-D* | 14,22 48,56 | O | Request to send. (active low) To indicate that the transmitter has data ready to send. Writing a "1" in the modem control register (MCR bit-1) will set this pin to a low state. After the reset this pin will be set to high. Note that this pin does not have any effect on the transmit or receive operation. |
| DTR A-B* DTR C-D* | 12,24 46,58 | O | Data terminal ready. (active low) To indicate that ST16C554 is ready to receive data. This pin can be controlled via the modem control register (MCR bit-0). Writing a "1" at the MCR bit-0 will set the DTR* output to low. |

** ST16C554D PARTS ONLY

ST16C554

ST16C554D

ST16C554/554D

SYMBOL DESCRIPTION

| Symbol | Pin | Signal Type | Pin Description |
|----------------------|----------------|-------------|---|
| RESET | 37 | I | This pin will be set to high state after writing a "0" to that register or after the reset . Note that this pin does not have any effect on the transmit or receive operation. Master reset. (active high) A high on this pin will reset all the outputs and internal registers. The transmitter output and the receiver input will be disabled during reset time. |
| CTS A-B* CTS C-D* | 11,25 45,59 | I | Clear to send. (active low) The CTS* signal is a MODEM control function input whose conditions can be tested by reading the MSR BIT-4. CTS* has no effect on the transmit or receive operation. |
| DSR A-B* DSR C-D* | 10,26 44,60 | I | Data set ready. (active low) A low on this pin indicates the MODEM is ready to exchange data with UART. This pin does not have any effect on the transmit or receive operation. |
| CD A-B* CD C-D* | 9,27 43,61 | I | Carrier detect. (active low) A low on this pin indicates the carrier has been detected by the modem. |
| RI A-B* RI C-D* | 8,28 42,62 | I | Ring detect indicator. (active low) A low on this pin indicates the modem has received a ringing signal from telephone line. |
| VCC VCC | 13,30 47,64 | I | Power supply input. |

ST16C554

ST16C554D

ST16C554/554D

ST16C554 ACCESSIBLE REGISTERS

| A2 A1 A0 | Register | BIT-7 | BIT-6 | BIT-5 | BIT-4 | BIT-3 | BIT-2 | BIT-1 | BIT-0 |
|--------------|------------|----------------------|--------------------|----------------------|-----------------|------------------------|-------------------------------|---------------------------|--------------------------|
| 0 0 0 | RHR | bit-7 | bit-6 | bit-5 | bit-4 | bit-3 | bit-2 | bit-1 | bit-0 |
| 0 0 0 | THR | bit-7 | bit-6 | bit-5 | bit-4 | bit-3 | bit-2 | bit-1 | bit-0 |
| 0 0 1 | IER | 0 | 0 | 0 | 0 | modem status interrupt | receive line status interrupt | transmit holding register | receive holding register |
| 0 1 0 | FCR | RCVR trigger (MSB) | RCVR trigger (LSB) | 0 | 0 | DMA mode select | XMIT FIFO reset | RCVR FIFO reset | FIFO enable |
| 0 1 0 | ISR | 0/ FIFOs enabled | 0/ FIFOs enabled | 0 | 0 | int priority bit-2 | int priority bit-1 | int priority bit-0 | int status |
| 0 1 1 | LCR | divisor latch enable | set break | set parity | even parity | parity enable | stop bits | word length bit-1 | word length bit-0 |
| 1 0 0 | MCR | 0 | 0 | 0 | loop back | INT enable | Not used | RTS* | DTR* |
| 1 0 1 | LSR | 0/ FIFO error | trans. empty | trans. holding empty | break interrupt | framing error | parity error | overrun error | receive data ready |
| 1 1 0 | MSR | CD | RI | DSR | CTS | delta CD* | delta RI* | delta DSR* | delta CTS* |
| 1 1 1 | SPR | bit-7 | bit-6 | bit-5 | bit-4 | bit-3 | bit-2 | bit-1 | bit-0 |
| 0 0 0 | DLL | bit-7 | bit-6 | bit-5 | bit-4 | bit-3 | bit-2 | bit-1 | bit-0 |
| 0 0 1 | DLM | bit-15 | bit-14 | bit-13 | bit-12 | bit-11 | bit-10 | bit-9 | bit-8 |

DLL and DLM are accessible only when LCR bit-7 is set to "1".

ST16C554

ST16C554D

ST16C554/554D

PROGRAMMING TABLE

| A2 | A1 | A0 | READ MODE | WRITE MODE |
|----|----|----|---------------------------|---------------------------|
| 0 | 0 | 0 | Receive Holding Register | Transmit Holding Register |
| 0 | 0 | 1 | | Interrupt Enable Register |
| 0 | 1 | 0 | Interrupt Status Register | FIFO Control Register |
| 0 | 1 | 1 | | Line Control Register |
| 1 | 0 | 0 | | Modem Control Register |
| 1 | 0 | 1 | Line Status Register | |
| 1 | 1 | 0 | Modem Status Register | |
| 1 | 1 | 1 | Scratchpad Register | Scratchpad Register |
| 0 | 0 | 0 | | LSB of Divisor Latch |
| 0 | 0 | 1 | | MSB of Divisor Latch |



REGISTER FUNCTIONAL DESCRIPTIONS

TRANSMIT AND RECEIVE HOLDING REGISTER

The serial transmitter section consists of a Transmit Hold Register (THR) and Transmit Shift Register (TSR). The status of the transmit hold register is provided in the Line Status Register (LSR). Writing to this register (THR) will transfer the contents of data bus (D7-D0) to the Transmit holding register whenever the transmitter holding register or transmitter shift register is empty. The transmit holding register empty flag will be set to "1" when the transmitter is empty or data is transferred to the transmit shift register. Note that a write operation should be performed when the transmit holding register empty flag is set.

On the falling edge of the start bit, the receiver internal counter will start to count 7 1/2 clocks (16x clock) which is the center of the start bit. The start bit is valid if the RX is still low at the mid-bit sample of the start bit. Verifying the start bit prevents the receiver from assembling a false data character due to a low going noise spike on the RX input. Receiver status codes will be posted in the Line Status Register.

FIFO INTERRUPT MODE OPERATION

When the receive FIFO (FCR BIT-0=1) and receive interrupts (IER BIT-0=1) are enabled, receiver interrupt will occur as follows:

- A) The receive data available interrupts will be issued to the CPU when the FIFO has reached its programmed trigger level; it will be cleared as soon as the FIFO drops below its programmed trigger level.
- B) The ISR receive data available indication also occurs when the FIFO trigger level is reached, and like the interrupt it is cleared when the FIFO drops below the trigger level.
- C) The data ready bit (LSR BIT-0) is set as soon as a character is transferred from the shift register to the receiver FIFO. It is reset when the FIFO is empty.

FIFO POLLED MODE OPERATION

When FCR BIT-0=1; resetting IER BIT 3-0 to zero puts the ST16C554 in the FIFO polled mode of operation. Since the receiver and transmitter are controlled separately either one or both can be in the polled mode operation by utilizing the Line Status Register.

ST16C554

ST16C554D

- A) LSR BIT-0 will be set as long as there is one byte in the receive FIFO.
- B) LSR BIT-1 will specify which error(s) has occurred.
- C) LSR BIT-5 will indicate when the transmit FIFO is empty.
- D) LSR BIT-6 will indicate when both transmit FIFO and transmit shift register are empty.
- E) LSR BIT-7 will indicate when there are any errors in the receive FIFO.

The ST16C554 requires to have two step FIFO enable operation in order to enable receive trigger levels.

PROGRAMMABLE BAUD RATE GENERATOR

The ST16C554 contains a programmable Baud Rate Generator that is capable of taking any clock input from DC-8 MHz and dividing it by any divisor from 1 to $2^{16} - 1$. The output frequency of the Baudout* is equal to 16X of transmission baud rate (Baudout* = 16 x Baud Rate). Customize Baud Rates can be achieved by selecting proper divisor values for MSB and LSB of baud rate generator.

INTERRUPT ENABLE REGISTER (IER)

The Interrupt Enable Register (IER) masks the incoming interrupts from receiver ready, transmitter empty, line status and modem status registers to the INT output pin.

IER BIT-0:

0=disable the receiver ready interrupt.
1=enable the receiver ready interrupt.

IER BIT-1:

0=disable the transmitter empty interrupt.
1=enable the transmitter empty interrupt.

IER BIT-2:

0=disable the receiver line status interrupt.
1=enable the receiver line status interrupt.

IER BIT-3:

0=disable the modem status register interrupt.
1=enable the modem status register interrupt.

IER BIT 7-4:

All these bits are set to logic zero.

INTERRUPT STATUS REGISTER (ISR)

The ST16C554 provides four level prioritized interrupt conditions to minimize software overhead during data character transfers. The Interrupt Status Register (ISR) provides the source of the interrupt in prioritized matter. During the read cycle the ST16C554 provides the highest interrupt level to be serviced by CPU. No other interrupts are acknowledged until the particular interrupt is serviced. The following are the prioritized interrupt levels:

Priority level

| P | D3 | D2 | D1 | D0 | Source of the interrupt |
|----|----|----|----|----|---|
| 1 | 0 | 1 | 1 | 0 | LSR (Receiver Line Status Register) |
| 2 | 0 | 1 | 0 | 0 | RXRDY (Received Data Ready) |
| 2* | 1 | 1 | 0 | 0 | RXRDY (Receive Data time out) |
| 3 | 0 | 0 | 1 | 0 | TXRDY (Transmitter Holding Register Empty) |
| 4 | 0 | 0 | 0 | 0 | MSR (Modem Status Register) |

*RECEIVE TIME-OUT:

This mode is enabled when STARTECH UART is operating in FIFO mode. Receive time out will not occur if the receive FIFO is empty. The time out counter will be reset at the center of each stop bit received or each time receive holding register is read. The actual time out value is T (Time out length in bits) = $4 \times P$ (Programmed word length) + 12. To convert time out value to a character value, user has to divide this number to its complete word length + parity (if used) + number of stop bits and start bit.

ST16C554

ST16C554D

ST16C554/554D

Example -A: If user programs the word length = 7, and no parity and one stop bit, Time out will be:
 $T = 4 \times 7(\text{programmed word length}) + 12 = 40$ bits
Character time = $40 / 9$ [(programmed word length = 7) + (stop bit = 1) + (start bit = 1)] = 4.4 characters.

Example -B: If user programs the word length = 7, with parity and one stop bit, the time out will be:
 $T = 4 \times 7(\text{programmed word length}) + 12 = 40$ bits
Character time = $40 / 10$ [(programmed word length = 7) + (parity = 1) + (stop bit = 1) + (start bit = 1)] = 4 characters.

ISR BIT-0:

0=an interrupt is pending and the ISR contents may be used as a pointer to the appropriate interrupt service routine.
1=no interrupt pending.

ISR BIT 1-3:

Logical combination of these bits, provides the highest priority interrupt pending.

ISR BIT 4-7:

These bits are not used and are set to zero in ST16C450 mode. **BIT 6-7:** are set to "1" in ST16C554 mode.

FIFO CONTROL REGISTER (FCR)

This register is used to enable the FIFOs, clear the FIFOs, set the receiver FIFO trigger level, and select the type of DMA signaling.

FCR BIT-0:

0=Disable the transmit and receive FIFO.
1=Enable the transmit and receive FIFO.
This bit should be enabled before setting the FIFO trigger levels.

FCR BIT-1:

0=No change.
1=Clears the contents of the receive FIFO and resets its counter logic to 0 (the receive shift register is not cleared or altered). This bit will return to zero after clearing the FIFOs.

FCR BIT-2:

0=No change.
1=Clears the contents of the transmit FIFO and resets its counter logic to 0 (the transmit shift register is not cleared or altered). This bit will return to zero after clearing the FIFOs.

FCR BIT-3:

0=No change.
1=Changes RXRDY and TXRDY pins from mode "0" to mode "1".

Transmit operation in mode "0":

When ST16C554 is in ST16C450 mode (FCR bit-0=0) or in the FIFO mode (FCR bit-0=1, FCR bit-3=0) when there are no characters in the transmit FIFO or transmit holding register, the TXRDY* pin will go low. Once active the TXRDY* pin will go high (inactive) after the first character is loaded into the transmit holding register.

Receive operation in mode "0":

When ST16C554 is in ST16C450 mode (FCR bit-0=0) or in the FIFO mode (FCR bit-0=1, FCR bit-3=0) and there is at least 1 character in the receive FIFO, the RXRDY* pin will go low. Once active the RXRDY* pin will go high (inactive) when there are no more characters in the receiver.

Transmit operation in mode "1":

When ST16C554 is in ST16C550 mode (FCR bit-0=1, FCR bit-3=1) the TXRDY* pin will become high (inactive) when the transmit FIFO is completely full. It will be low if one or more FIFO locations are empty.

Receive operation in mode "1":

When ST16C554 is in ST16C550 mode (FCR bit-0=1, FCR bit-3=1) and the trigger level or the timeout has been reached, the RXRDY* pin will go low. Once it is activated it will go high (inactive) when there are no more characters in the FIFO.

FCR BIT 4-5:

Not used.

FCR BIT 6-7:

These bits are used to set the trigger level for the receiver FIFO interrupt.



ST16C554

ST16C554D

| BIT-7 | BIT-6 | FIFO trigger level |
|-------|-------|--------------------|
| 0 | 0 | 01 |
| 0 | 1 | 04 |
| 1 | 0 | 08 |
| 1 | 1 | 14 |

LINE CONTROL REGISTER (LCR)

The Line Control Register is used to specify the asynchronous data communication format. The number of the word length, stop bits, and parity can be selected by writing appropriate bits in this register.

LCR BIT1-0:

These two bits specify the word length to be transmitted or received.

| BIT-1 | BIT-0 | Word length |
|-------|-------|-------------|
| 0 | 0 | 5 |
| 0 | 1 | 6 |
| 1 | 0 | 7 |
| 1 | 1 | 8 |

LCR BIT-2:

The number of stop bits can be specified by this bit.

| BIT-2 | Word length | Stop bit(s) |
|-------|-------------|-------------|
| 0 | 5,6,7, | 1 |
| 1 | 5 | 1-1/2 |
| 1 | 6,7,8 | 2 |

LCR BIT-3:

Parity or no parity can be selected via this bit.

0=no parity

1=a parity bit is generated during the transmission, receiver also checks for received parity.

LCR BIT-4:

If the parity bit is enabled, LCR BIT-4 selects the even or odd parity format.

0=ODD parity is generated by forcing an odd number of 1's in the transmitted data, receiver also checks for same format.

1= EVEN parity bit is generated by forcing an even the number of 1's in the transmitted data, receiver also checks for same format.

LCR BIT-5:

If the parity bit is enabled, LCR BIT-5 selects the forced parity format.

LCR BIT-5=1 and LCR BIT-4=0, parity bit is forced to "1" in the transmitted and received data.

LCR BIT-5=1 and LCR BIT-4=1, parity bit is forced to "0" in the transmitted and received data.

LCR BIT-6:

Break control bit. It causes a break condition to be transmitted (the TX is forced to low state).

0=normal operating condition.

1=forces the transmitter output (TX) to go low to alert the communication terminal.

LCR BIT-7:

The internal baud rate counter latch enable (DLAB).

0=normal operation.

1=select divisor latch register.

MODEM CONTROL REGISTER (MCR)

This register controls the interface with the MODEM or a peripheral device (RS232).

MCR BIT-0:

0=force DTR* output to high.

1=force DTR* output to low.

MCR BIT-1:

0=force RTS* output to high.

1=force RTS* output to low.

MCR BIT-2:

Not used, except in internal loop-back mode.

MCR BIT-3:

0=set the INT A-D output pin to three state mode..

1=Enable the INT A-D output pin.

ST16C554

ST16C554D

ST16C554/554D

MCR BIT-4:

0=normal operating mode.

1=enable local loop-back mode (diagnostics). The transmitter output (TX) is set high (Mark condition), the receiver input (RX), CTS*, DSR*, CD*, and RI* are disabled. Internally the transmitter output is connected to the receiver input and DTR*, RTS*, MCR bit-2 and INT enable are connected to modem control inputs.

In this mode, the receiver and transmitter interrupts are fully operational. The Modem Control Interrupts are also operational, but the interrupt sources are now the lower four bits of the Modem Control Register instead of the four Modem Control inputs. The interrupts are still controlled by the IER.

MCR BIT 5-7:

Not used. Are set to zero permanently.

LINE STATUS REGISTER (LSR)

This register provides the status of data transfer to CPU.

LSR BIT-0:

0=no data in receive holding register or FIFO.

1=data has been received and saved in the receive holding register or FIFO.

LSR BIT-1:

0=no overrun error (normal).

1=overrun error, next character arrived before receive holding register was emptied or if FIFOs are enabled, an overrun error will occur only after the FIFO is full and the next character has been completely received in the shift register. Note that character in the shift register is overwritten, but it is not transferred to the FIFO.

LSR BIT-2:

0=no parity error (normal).

1=parity error, received data does not have correct parity information. In the FIFO mode this error is associated with the character at the top of the FIFO.

LSR BIT-3:

0=no framing error (normal).

1=framing error received, received data did not have

a valid stop bit. In the FIFO mode this error is associated with the character at the top of the FIFO.

LSR BIT-4:

0=no break condition (normal).

1=receiver received a break signal (RX was low for one character time frame). In FIFO mode, only one zero character is loaded into the FIFO.

LSR BIT-5:

0=transmit holding register is full. ST16C554 will not accept any data for transmission.

1=transmit holding register (or FIFO) is empty. CPU can load the next character.

LSR BIT-6:

0=transmitter holding and shift registers are full.

1=transmitter holding and shift registers are empty. In FIFO mode this bit is set to one whenever the transmitter FIFO and transmit shift register are empty.

LSR BIT-7:

0=Normal.

1=At least one parity error, framing error or break indication in the FIFO. This bit is cleared when LSR is read.

MODEM STATUS REGISTER (MSR)

This register provides the current state of the control lines from the modem or peripheral to the CPU. Four bits of this register are used to indicate the changed information. These bits are set to "1" whenever a control input from the MODEM changes state. They are set to "0" whenever the CPU reads this register.

MSR BIT-0:

Indicates that the CTS* input to the ST16C554 has changed state since the last time it was read.

MSR BIT-1:

Indicates that the DSR* input to the ST16C554 has changed state since the last time it was read.

MSR BIT-2:

Indicates that the RI* input to the ST16C554 has changed from a low to a high state.

3

ST16C554

ST16C554D

MSR BIT-3:

Indicates that the CD* input to the ST16C554 has changed state since the last time it was read.

MSR BIT-4:

This bit is equivalent to RTS in the MCR during local loop-back mode. It is the compliment of the CTS* input.

MSR BIT-5:

This bit is equivalent to DTR in the MCR during local loop-back mode. It is the compliment of the DSR* input.

MSR BIT-6:

This bit is equivalent to MCR bit-2 during local loop-back mode. It is the compliment of the RI* input.

MSR BIT-7:

This bit is equivalent to INT enable in the MCR during local loop-back mode. It is the compliment to the CD* input.

Note: Whenever MSR BIT3-0: is set to logic "1", a MODEM Status Interrupt is generated.

SCRATCHPAD REGISTER (SR)

ST16C554 provides a temporary data register to store 8 bits of information for variable use.

BAUD RATE GENERATOR PROGRAMMING TABLE (1.8432 MHz CLOCK):

| BAUD RATE | 16 x CLOCK DIVISOR | % ERROR |
|-----------|--------------------|---------|
| 50 | 2304 | 0.026 |
| 110 | 1047 | |
| 150 | 768 | |
| 300 | 384 | |
| 600 | 192 | |
| 1200 | 96 | |
| 2400 | 48 | |
| 4800 | 24 | |
| 7200 | 16 | |
| 9600 | 12 | |
| 19.2K | 6 | |
| 38.4K | 3 | 2.77 |
| 56K | 2 | |
| 115.2K | 1 | |

ST16C554 EXTERNAL RESET CONDITION

| REGISTERS | RESET STATE |
|-----------|--|
| IER | IER BITS 0-7=0 |
| ISR | ISR BIT-0=1, ISR BITS 1-7=0 |
| LCR | LCR BITS 0-7=0 |
| MCR | MCR BITS 0-7=0 |
| LSR | LSR BITS 0-4=0, LSR BITS 5-6=1 LSR, BIT 7=0 |
| MSR | MSR BITS 0-3=0, MSR BITS 4-7=input signals |
| FCR | FCR BITS 0-7=0 |

| SIGNALS | RESET STATE |
|---------|------------------|
| TX | High |
| RTS* | High |
| DTR* | High |
| RXRDY* | High |
| TXRDY | Low |
| INT | Three state mode |

ST16C554

ST16C554D

ST16C554/554D

AC ELECTRICAL CHARACTERISTICS

$T_A = 0^\circ - 70^\circ \text{C}$, $V_{CC} = 5.0 \text{V} \pm 10\%$ unless otherwise specified.

| Symbol | Parameter | Limits | | | Units | Conditions |
|----------|--|--------|-----|-------------------|---------------|----------------|
| | | Min | Typ | Max | | |
| T_1 | Clock high pulse duration | 50 | | | ns | External clock |
| T_2 | Clock low pulse duration | 50 | | | ns | |
| T_3 | Clock rise/fall time | | | 10 | ns | |
| T_8 | Chip select setup time | 5 | | | ns | |
| T_9 | Chip select hold time | 0 | | | ns | |
| T_{12} | Data setup time | 15 | | | ns | |
| T_{13} | Data hold time | 15 | | | ns | |
| T_{14} | IOW* delay from chip select | 10 | | | ns | |
| T_{15} | IOW* strobe width | 50 | | | ns | |
| T_{16} | Chip select hold time from IOW* | 0 | | | ns | |
| T_{17} | Write cycle delay | 55 | | | ns | |
| T_w | Write cycle = $T_{15} + T_{17}$ | 105 | | | ns | |
| T_{19} | Data hold time | 15 | | 25 | ns | |
| T_{21} | IOR* delay from chip select | 10 | | | ns | |
| T_{23} | IOR* strobe width | 65 | | | ns | |
| T_{24} | Chip select hold time from IOR* | 0 | | | ns | |
| T_{25} | Read cycle delay | 55 | | | ns | |
| T_r | Read cycle = $T_{23} + T_{25}$ | 115 | | | ns | |
| T_{26} | Delay from IOR* to data | | | 35 | ns | 100 pF load |
| T_{28} | Delay from IOW* to output | | | 50 | ns | 100 pF load |
| T_{29} | Delay to set interrupt from MODEM input | | | 70 | ns | 100 pF load |
| T_{30} | Delay to reset interrupt from IOR* | | | 70 | ns | 100 pF load |
| T_{31} | Delay from stop to set interrupt | | | 1 _{RCLK} | ns | 100 pF load |
| T_{32} | Delay from stop to reset interrupt | | | 200 | ns | 100 pF load |
| T_{33} | Delay from initial INT reset to transmit start | 8 | | 24 | * | |
| T_{34} | Delay from stop to interrupt | | | 100 | ns | |
| T_{35} | Delay from IOW* to reset interrupt | | | 175 | ns | |
| T_{44} | Delay from stop to set RxRdy | | | 1 _{RCLK} | ns | |
| T_{45} | Delay from IOR* to reset RxRdy | | | 1 | μs | |
| T_{46} | Delay from IOW* to set TxRdy | | | 195 | ns | |
| T_{47} | Delay from start to reset TxRdy | | | 8 | * | |
| N | Baud rate divisor | 1 | | $2^{16}-1$ | | |

Note 1: * = Baudout* cycle

ST16C554

ST16C554D

ABSOLUTE MAXIMUM RATINGS

| | |
|-----------------------|------------------------|
| Supply range | 7 Volts |
| Voltage at any pin | GND-0.3 V to VCC+0.3 V |
| Operating temperature | 0° C to +70° C |
| Storage temperature | -40° C to +150° C |
| Package dissipation | 500 mW |

DC ELECTRICAL CHARACTERISTICS

$T_A = 0^\circ - 70^\circ \text{ C}$, $V_{CC} = 5.0 \text{ V} \pm 10\%$ unless otherwise specified.

| Symbol | Parameter | Limits | | | Units | Conditions |
|------------|---------------------------------|--------|-----|----------|---------------|--------------------------|
| | | Min | Typ | Max | | |
| V_{ILCK} | Clock input low level | -0.5 | | 0.6 | V | |
| V_{IHCK} | Clock input high level | 3.0 | | VCC | V | |
| V_{IL} | Input low level | -0.5 | | 0.8 | V | |
| V_{IH} | Input high level | 2.2 | | VCC | V | |
| V_{OL} | Output low level on all outputs | | | 0.4 | V | $I_{OL} = 6 \text{ mA}$ |
| V_{OH} | Output high level | 2.4 | | | V | $I_{OH} = -6 \text{ mA}$ |
| I_{CC} | Avg power supply current | | 6 | | mA | |
| I_{IL} | Input leakage | | | ± 10 | μA | |
| I_{CL} | Clock leakage | | | ± 10 | μA | |

ST16C554 ST16C554D

ST16C554/554D

GENERAL WRITE TIMING

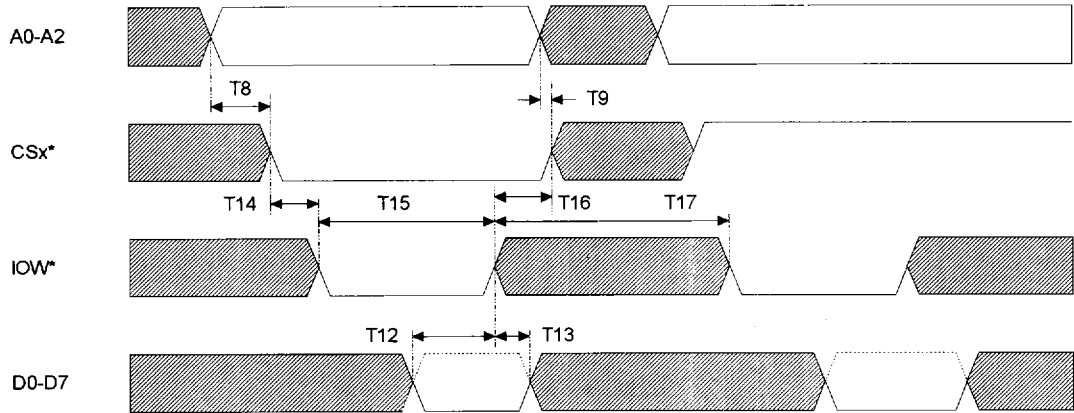

GENERAL READ TIMING

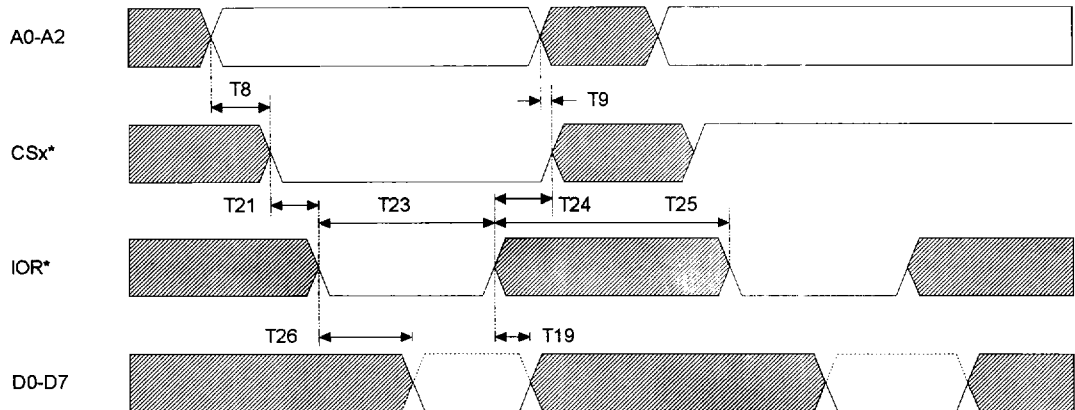

ST16C554 ST16C554D

MODEM TIMING

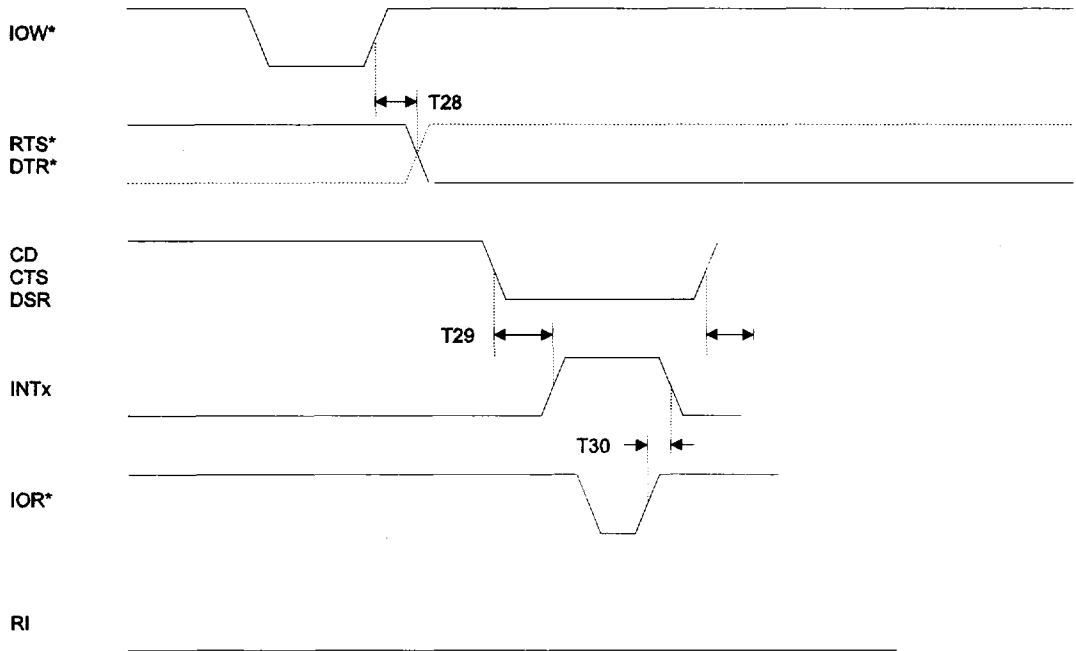

CLOCK TIMING

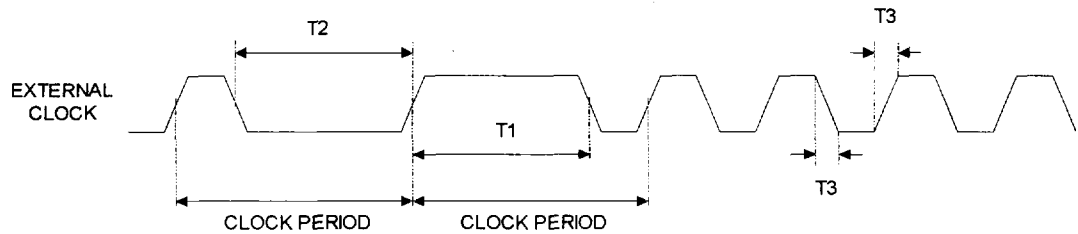

ST16C554 ST16C554D

ST16C554/554D

RECEIVE TIMING

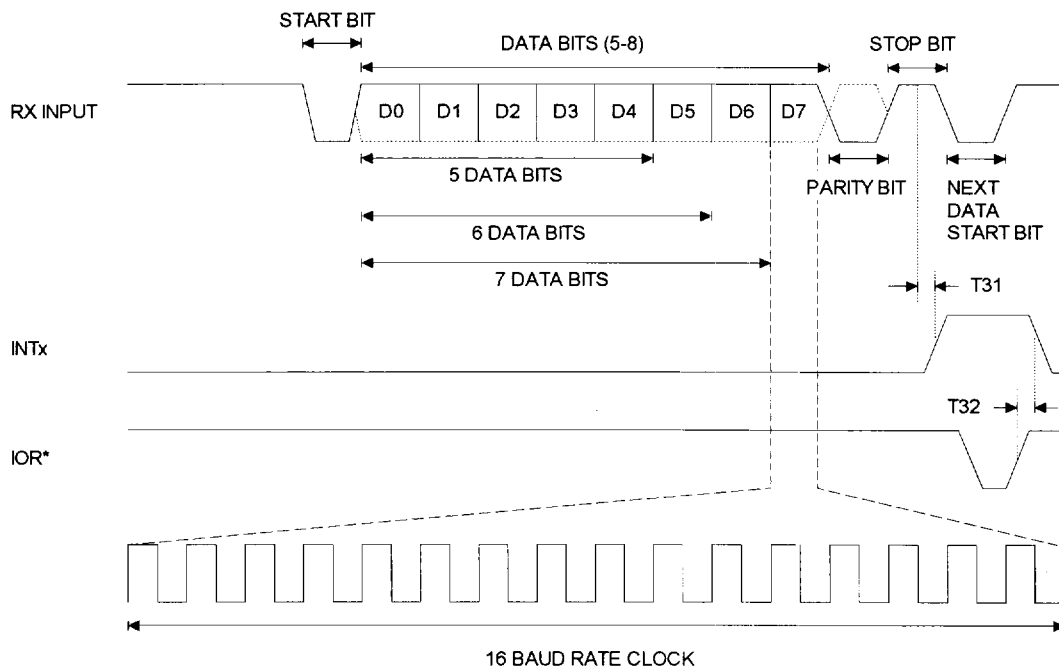

ST16C554

ST16C554D

RXRDY TIMING FOR MODE "0"

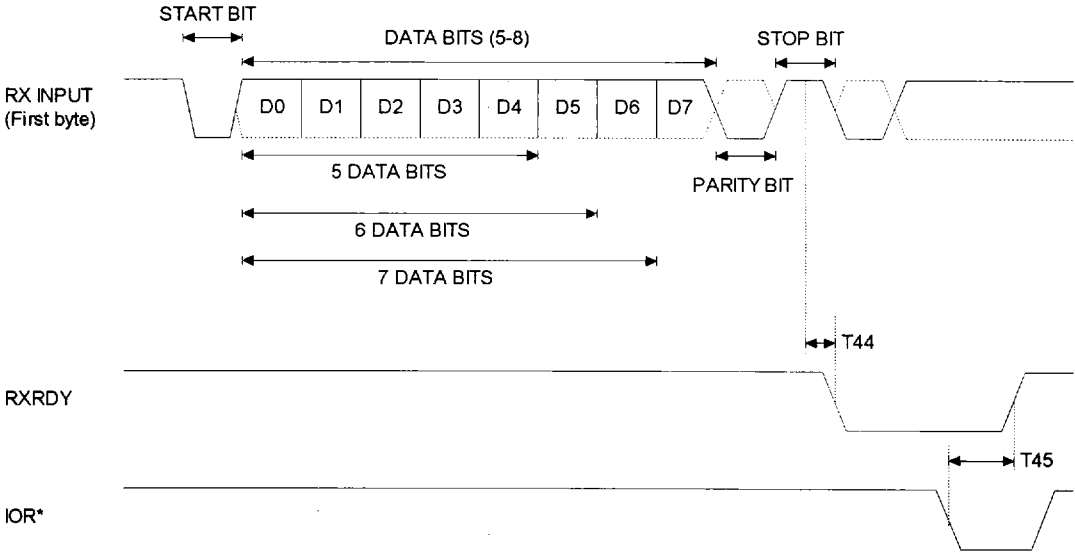

ST16C554 ST16C554D

ST16C554/554D

RXRDY TIMING FOR MODE "1"

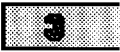
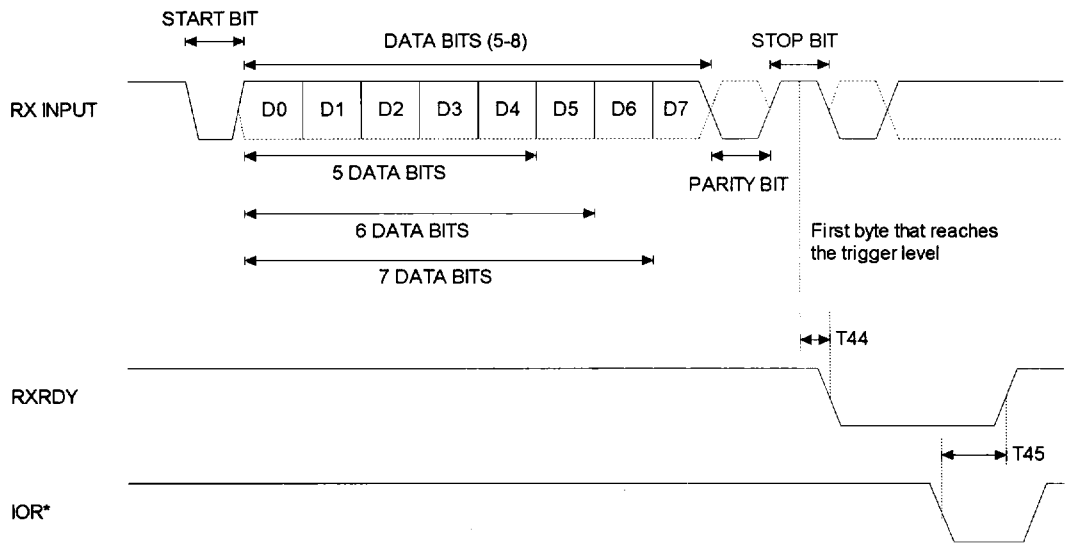

ST16C554

ST16C554D

TRANSMIT TIMING

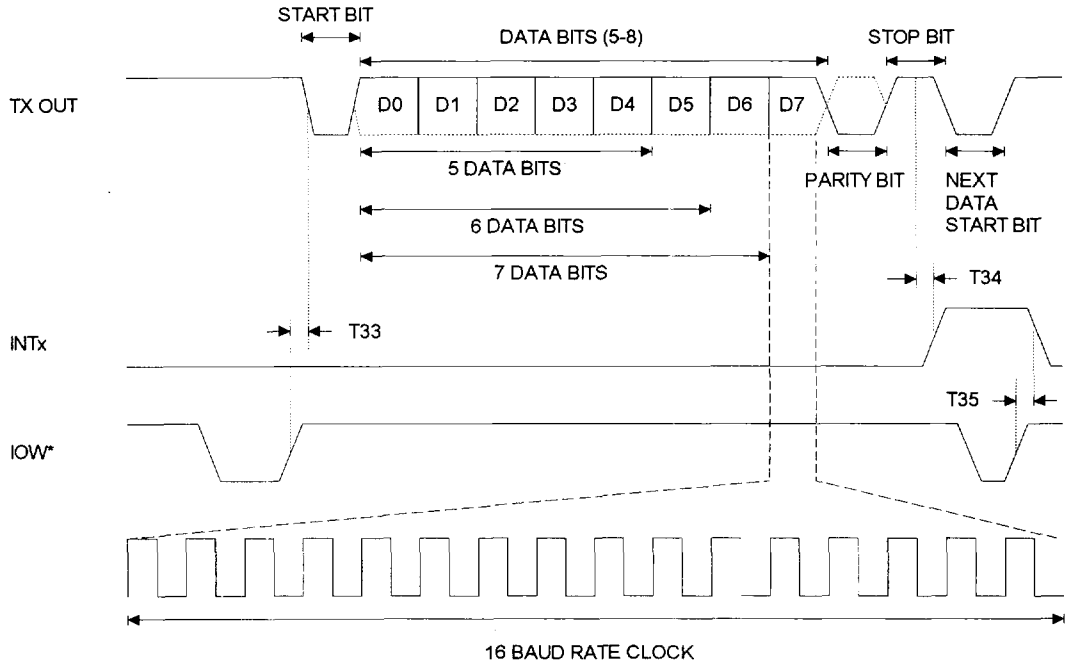

ST16C554 ST16C554D

ST16C554/554D

TXRDY TIMING FOR MODE "0"

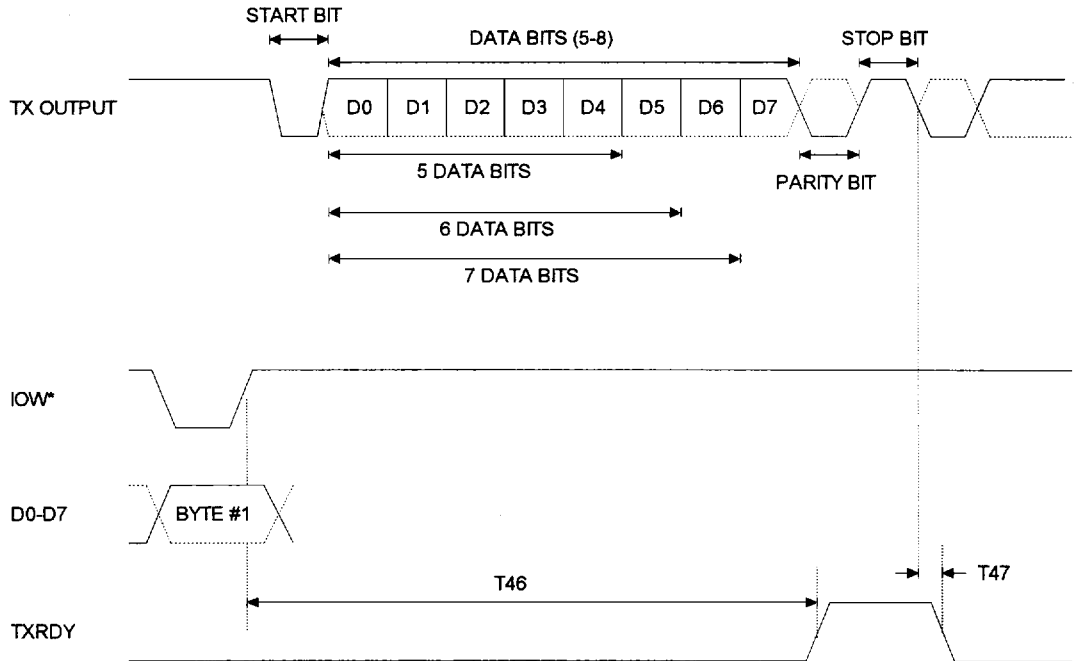

3

ST16C554 ST16C554D

TXRDY TIMING FOR MODE "1"

