

Technical Specification



Frequency Range(GHz)	0.8 – 8.0
Gain(dBi)	10 Typ.
Polarization	Linear
3dB Beamwidth(deg)	E Plane: 26 - 110
	H Plane: 24 - 67
Cross Pol. Isolation(dB)	30 Typ.
VSWR	1.5:1 Typ.
Connector	N-Female
	or SMA-Female
Power Handling(W)	N-Female: 300 Max. CW
	SMA-Female: 50 Max. CW
Material	Al
Size(mm)	284 x 183 x 252
Net Weight(Kg)	2.1 Around

Outline Drawing (Size: mm)

N-Female Output

For SMA-Female output outline drawing, please contact A-INFO.

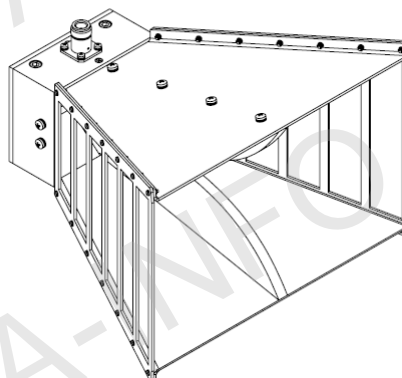
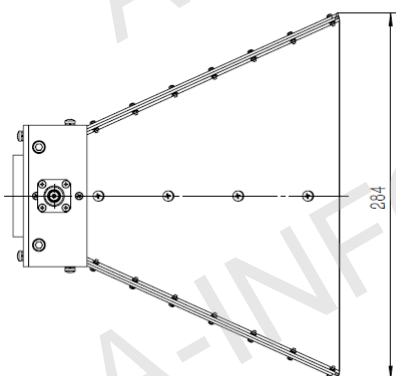
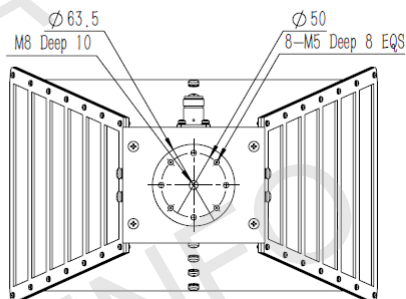
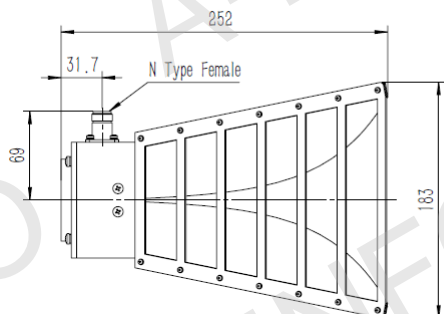

N-Female Output with L type Mounting Bracket

For SMA-Female output outline drawing, please contact A-INFO.

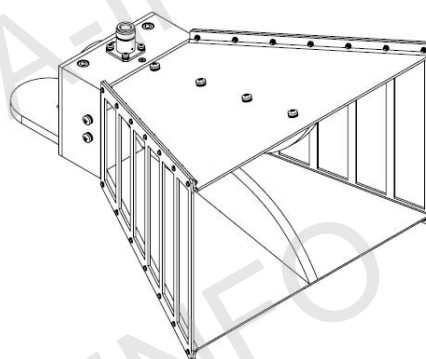
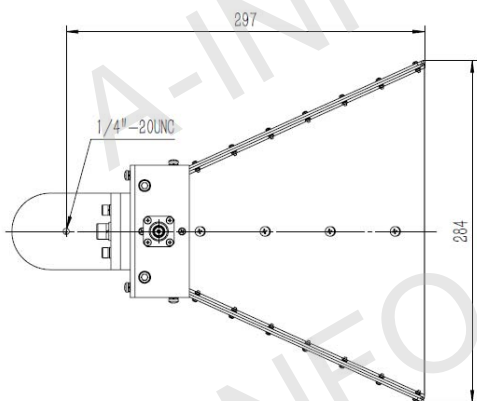
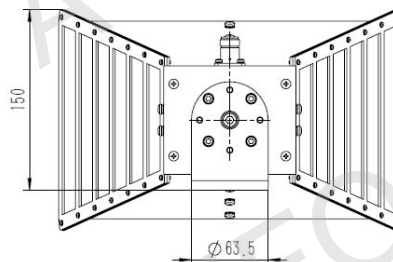
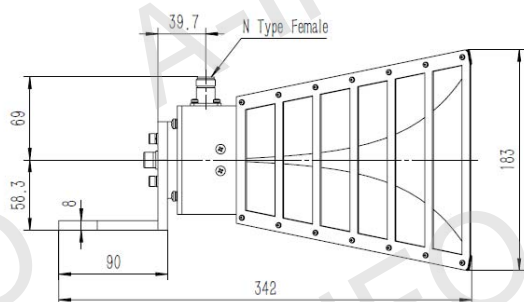

N-Female Output with Radome

For SMA-Female output outline drawing, please contact A-INFO.

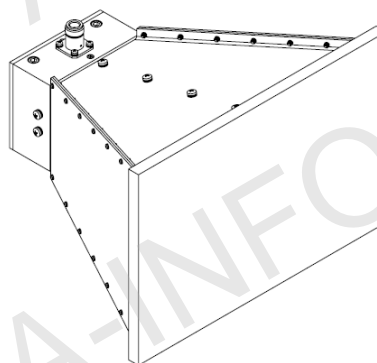
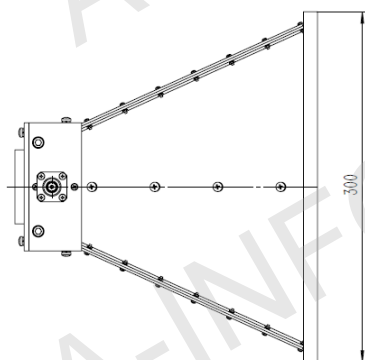
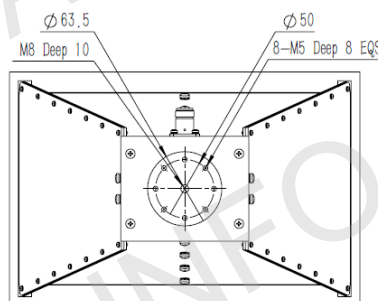
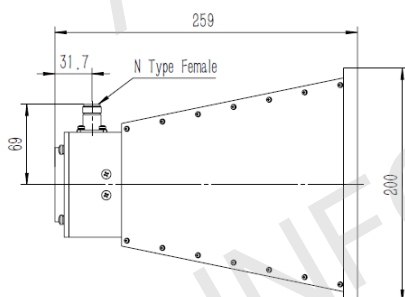

N-Female Output with L type Mounting Bracket and Radome

For SMA-Female output outline drawing, please contact A-INFO.

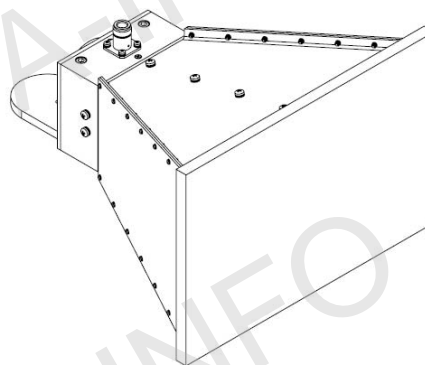
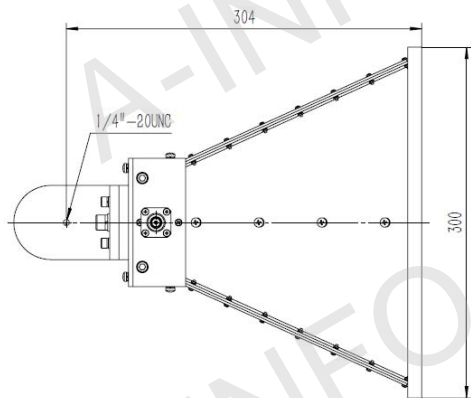
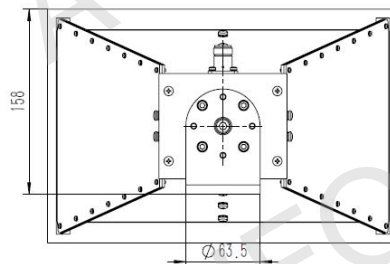
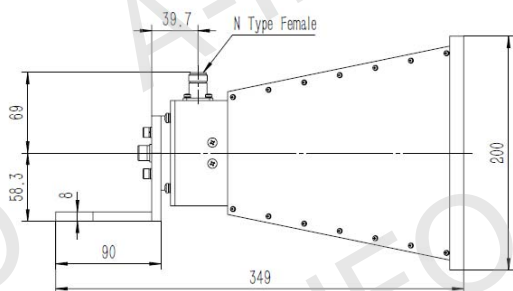

Test Results

1. Gain

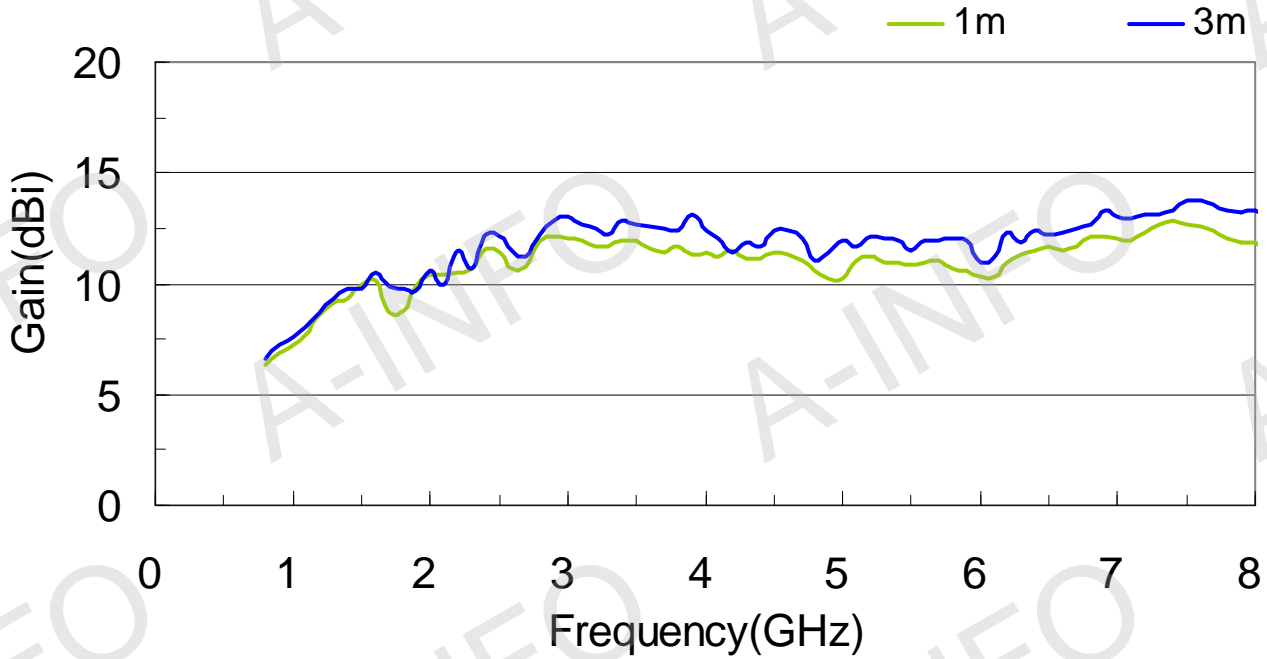

2. Antenna Factor

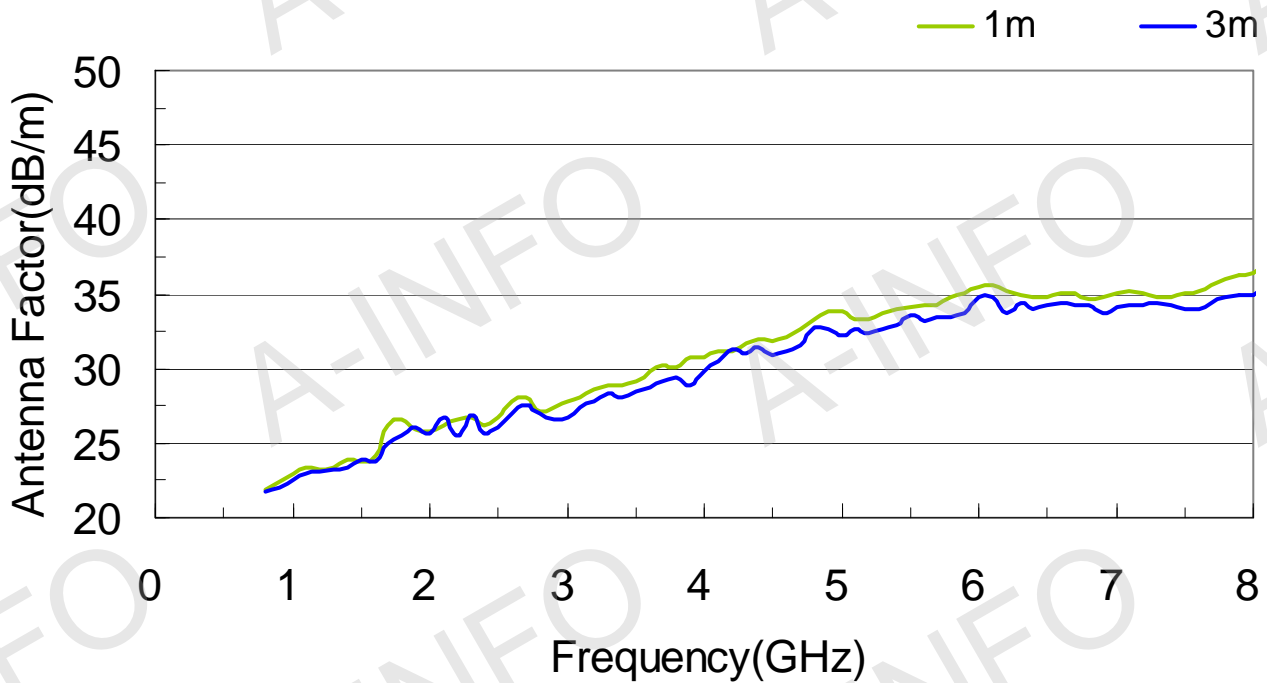

3. Cross Polarization Isolation

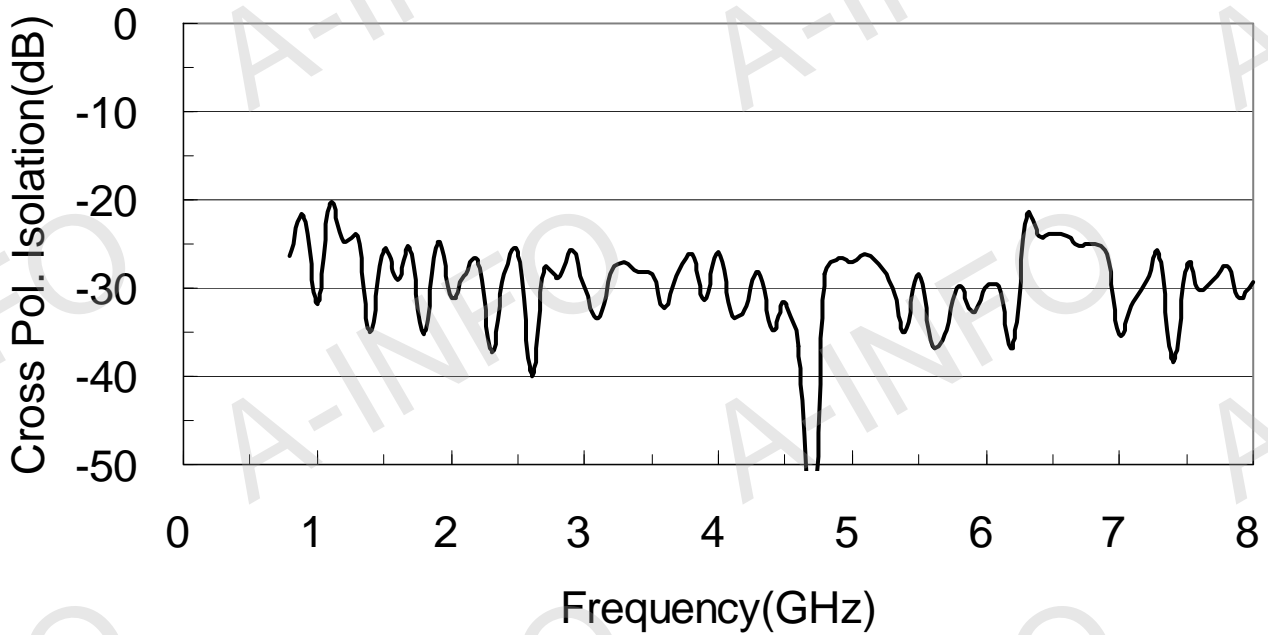

4. VSWR

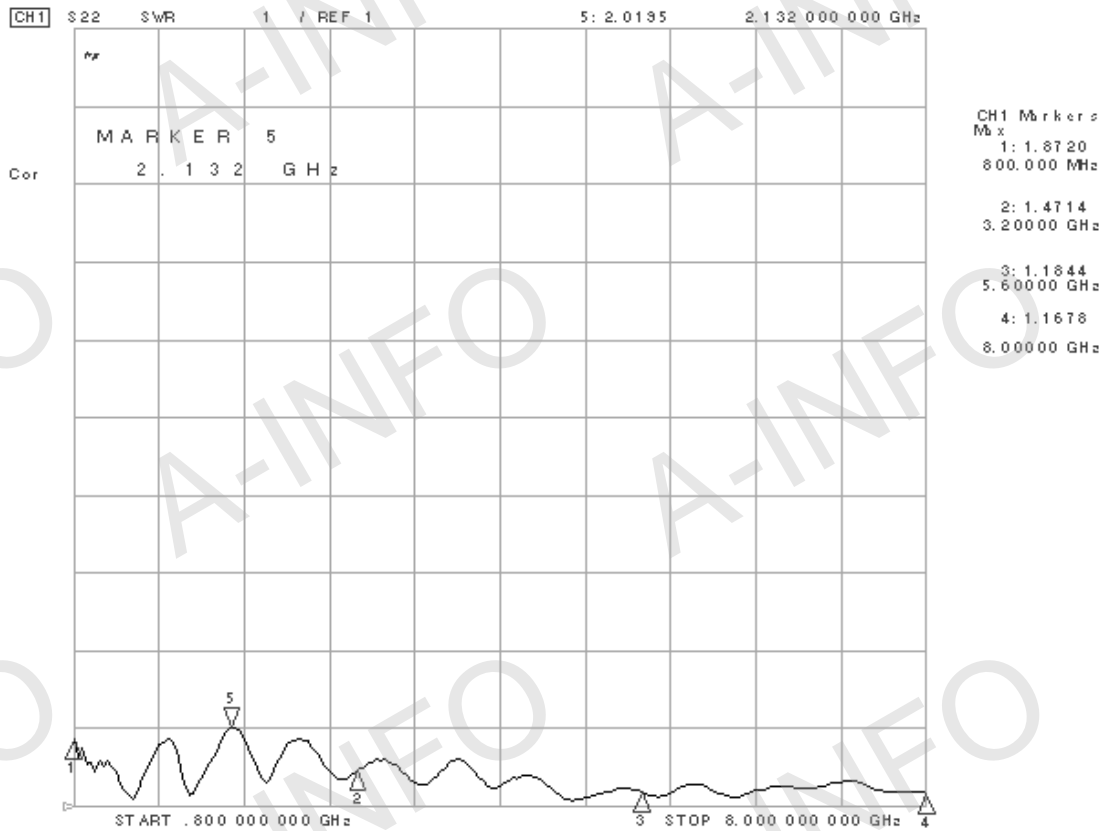

5. Pattern

