

## EN2® SERIES WEATHERTIGHT CONNECTORS

NEW PRODUCT BULLETIN 601

### FEATURES & BENEFITS

- Sealed to IP68 NEMA 250 (6P)
- Available in standard or winged coupling ring
- Copper Alloy, plated contacts
- Patented grommet and o-ring free design
- Solder, crimp and PC contact options

### APPLICATIONS

- Any sealed data transmission
- Military or industrial GPS location devices
- Instrumentation
- Medical data carts
- Marine Applications
- Transportation
- General industrial electronic applications



# SWITCHCRAFT®

A H E I C O C O M P A N Y



Please visit [www.switchcraft.com](http://www.switchcraft.com) for the most up-to-date product specifications. Made in USA.

# EN2® SERIES WEATHERTIGHT CONNECTORS

NEW PRODUCT BULLETIN 601

## SPECIFICATIONS

### MECHANICAL SPECIFICATIONS

Life:	600 insertion/withdrawal cycles minimum
Vibration:	Mil-Std 202G Method 201A
Hex Nut Torque:	5-6 in/lb
Operating Forces:	8 lb maximum insertion 0.25 lb minimum withdrawal
Back Shell Type:	Threaded Handle

### ELECTRICAL SPECIFICATIONS

Voltage Rating:	250 V AC/DC for 2 contact arrangement 125 V AC/DC for 3-7 contact arrangements
Current Rating:	Refer to current rating table
Insulation Resistance:	1000 MΩ minimum
Contact Resistance:	10 mΩ maximum

### ENVIRONMENTAL SPECIFICATIONS

Operating Temperature Limits:	-40°C to +85°C (-40°F to +185°F)
Moisture Resistance:	Mil-Std 202G Method 106G
Insulation Resistance:	Mil-Std 202G Method 302 Condition B
Thermal Shock:	Mil-Std 202G Method 107G
Salt Atmosphere (Corrosion):	Mil-Std 202G Method 101E Condition B
Weathertight Ratings:	IP16, IP18, IP66, IP67, IP68 per IEC60529 NEMA 250 (6P), CFR 46 Part 110.20

### MATERIAL SPECIFICATIONS

Connector Housing:	Thermoplastic, Black
Hex Nut:	Thermoplastic, Black
Coupling Ring:	Thermoplastic, Black
Cable Clamp:	Thermoplastic, Black
Handle (Back-Shell)	Thermoplastic, Black
Insulator:	Elastomer, Black
Seal Grommet:	Elastomer, Black
Contacts:	Copper Alloy, Plated



Please visit [www.switchcraft.com](http://www.switchcraft.com) for the most up-to-date product specifications. Made in USA.

# EN2® SERIES WEATHERTIGHT CONNECTORS

NEW PRODUCT BULLETIN 601

## EN2® SERIES CURRENT RATING TABLE

Contacts	Wire (awg)	Current Rating (A) at Operating Temperature (°C)				
		45°C max	55°C max	65°C max	75°C max	85°C max
2 #20	20	7	6	5	4	3.5
	22	5.5	5	4	3	2.5
	24	5.5	5	4	3	2.5
	26	4	3.5	2.5	2	1
3 #20	20	6.5	5.5	4.5	3.5	2
	22	5	4.5	3.5	3	1.5
	24	5	4.5	3.5	3	1.5
	26	3	2.5	2	1.5	0.5
4 #22	20	5	4.5	3.5	3	1.5
	22	4.5	4	3	2	1
	24	4.5	4	3	2	1
	26	3	2.5	2	1.5	0.5
5-7 #26	26	3	2.5	2	1.5	1
	28	2.5	2	1.5	1	0.5
	30	2	1.5	1	0.5	0.5

## ORDERING CODE

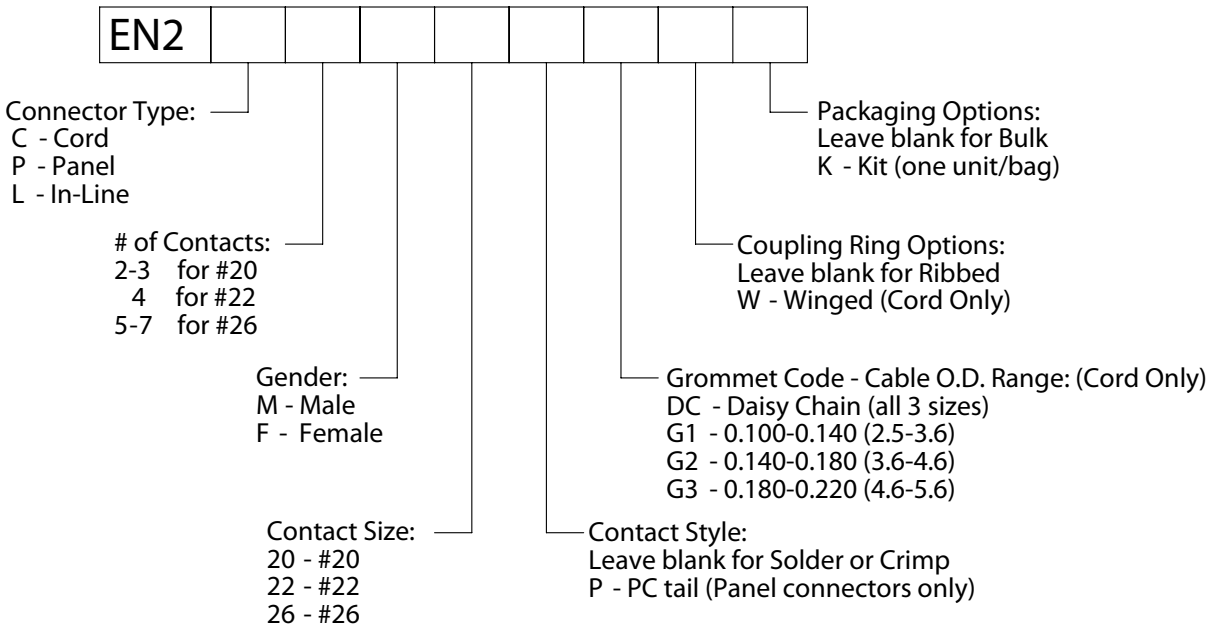

Note: In-Line type connectors not currently available.



Please visit [www.switchcraft.com](http://www.switchcraft.com) for the most up-to-date product specifications. Made in USA.

# EN2® SERIES WEATHERTIGHT CONNECTORS

## NEW PRODUCT BULLETIN 601

### CORD

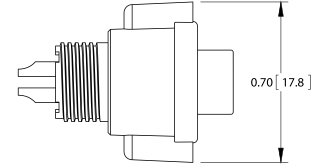
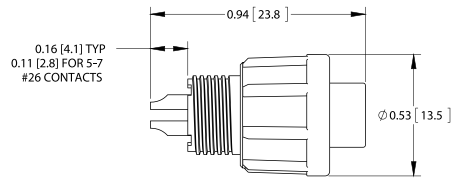
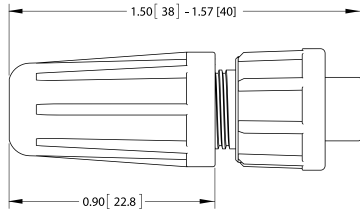

TYPICAL CORD CONNECTOR  
WITH RIBBED COUPLING RING

TYPICAL CORD CONNECTOR  
WITH WINGED COUPLING RING

ALL DIMENSIONS FOR REFERENCE ONLY

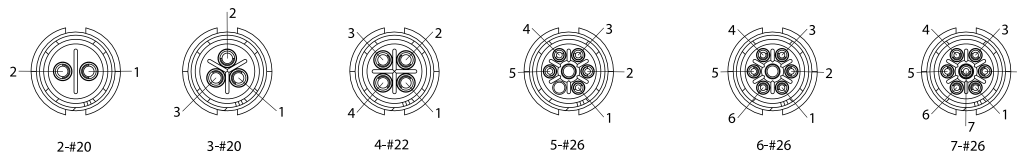

CONTACT ARRANGEMENTS  
CORD CONNECTOR REAR (WIRING SIDE) VIEW

### PANEL MOUNT

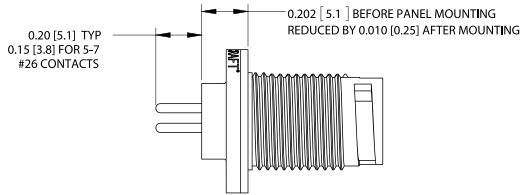
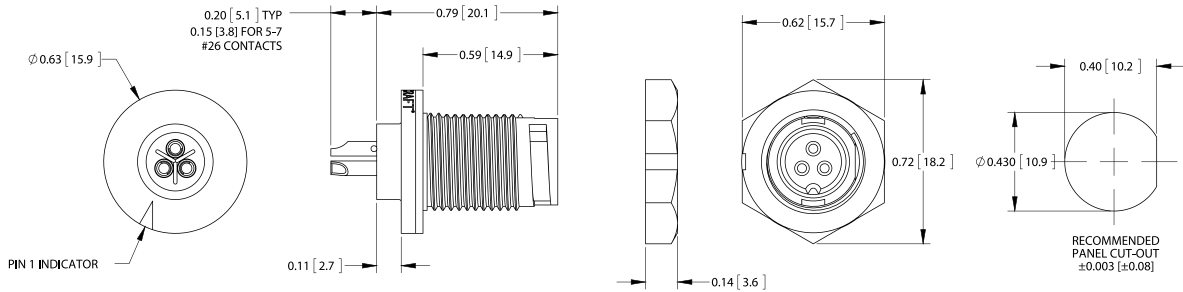

PC TAIL TYPE CONTACTS

ALL DIMENSIONS FOR REFERENCE ONLY

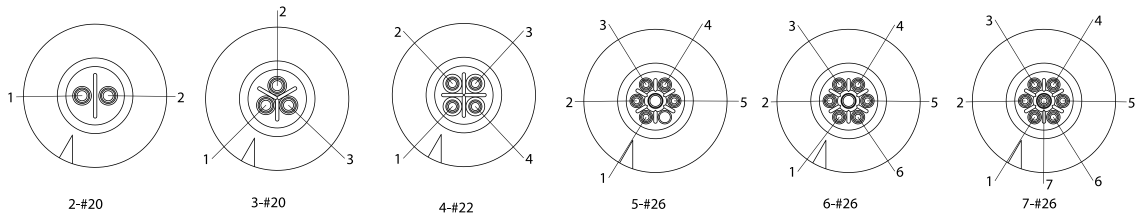

CONTACT ARRANGEMENTS  
PANEL CONNECTOR REAR (WIRING SIDE) VIEW

