

SSMB Cable Connectors

Click on part number to go directly to cable assembly instructions

Straight Cable Plugs

Crimp type for flexible cable

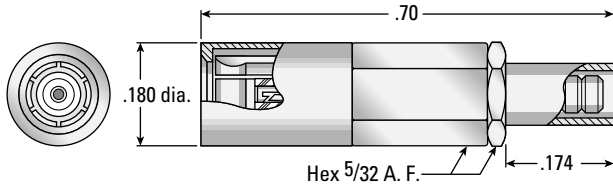

AEP P/N
7202-1572-0XX*

Solder type for semi-rigid cable

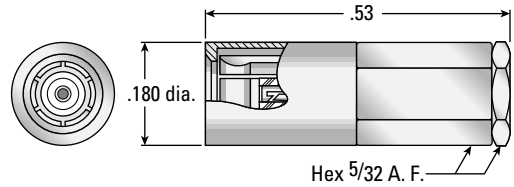

AEP P/N
7202-1542-0XX*

Right Angle Cable Plugs

Crimp type for flexible cable

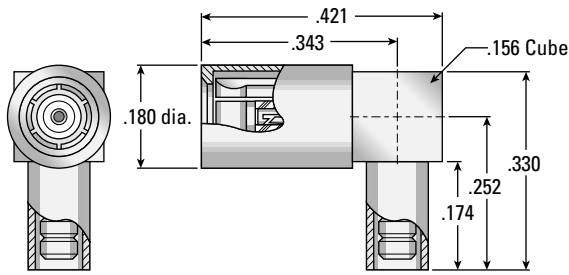

AEP P/N
7405-1521-0XX*

Solder type for semi-rigid cable

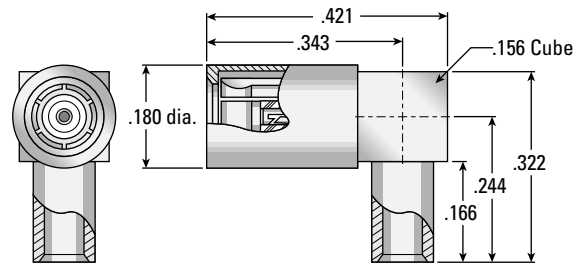

AEP P/N
7405-1561-0XX*

Straight Cable Jacks

Crimp type for flexible cable

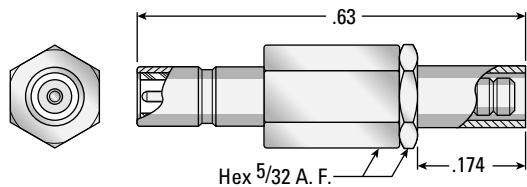

AEP P/N
7201-1571-0XX*

Solder type for semi-rigid cable

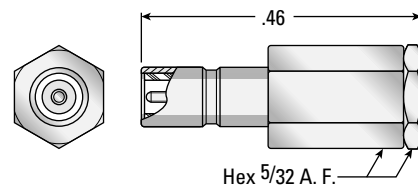

AEP P/N
7201-1541-0XX*

*Substitute the appropriate cable group number for "XX" when ordering:

GROUP	CABLE TYPES	GROUP	CABLE TYPES	GROUP	CABLE TYPES
02	RG178, RG196, M17/93, M17/169	05	RG178DS, RG196DS	19	RG174DS, RG316DS, M17/151, M17/152, Times RD-316
03	RG174, RG179, RG316, M17/113, M17/119, M17/172, M17/189	10	.085" semi-rigid, RG405, M17/133	21	.056" semi-rigid
		11	.047" semi-rigid, M17/151		

SSMB Cable Connectors

Click on part number to go directly to cable assembly instructions

Right Angle Cable Jacks

Crimp type for flexible cable

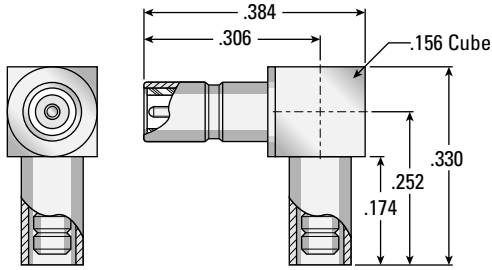

AEP P/N
7441-1521-0XX*

Solder type for semi-rigid cable

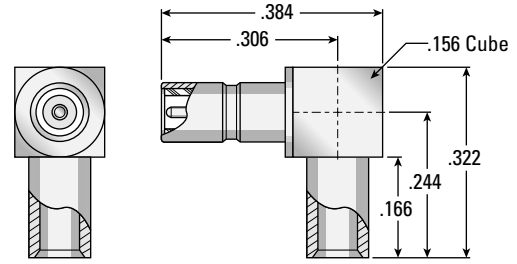

AEP P/N
7441-1561-0XX*

Straight Bulkhead Mounted Cable Jacks (.093" max panel thickness)

Crimp type for flexible cable

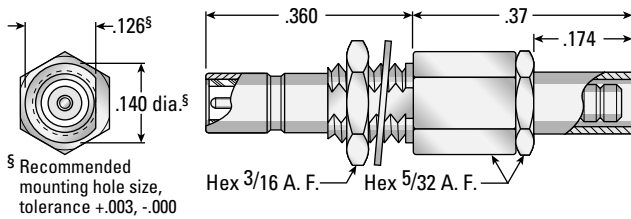

§ Recommended mounting hole size, tolerance +.003, -.000

AEP P/N
7203-1571-0XX*

Solder type for semi-rigid cable

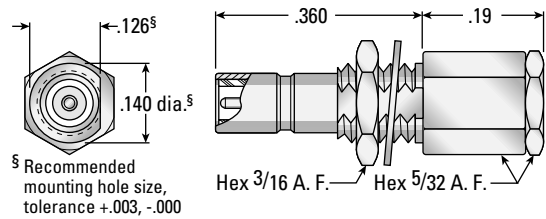

§ Recommended mounting hole size, tolerance +.003, -.000

AEP P/N
7203-1541-0XX*

Right Angle Bulkhead Mounted Cable Jacks (.125" max panel thickness)

Crimp type for flexible cable

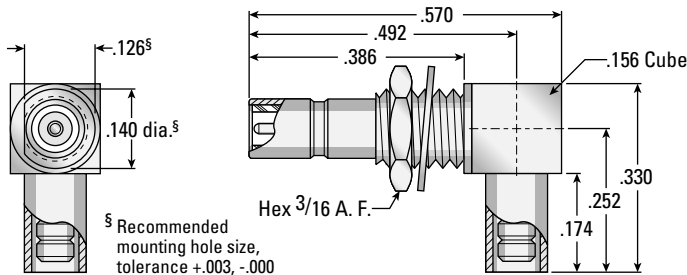

§ Recommended mounting hole size, tolerance +.003, -.000

AEP P/N
7406-1521-0XX*

Solder type for semi-rigid cable

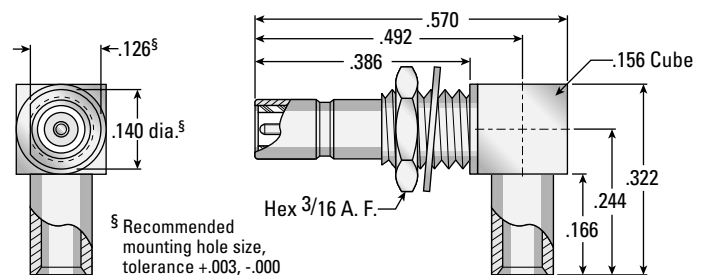

§ Recommended mounting hole size, tolerance +.003, -.000

AEP P/N
7406-1561-0XX*

These connectors can be supplied with other mating end lengths to accommodate a wide range of panel thicknesses—contact factory for availability.

*Substitute the appropriate cable group number for "XX" when ordering:

GROUP	CABLE TYPES	GROUP	CABLE TYPES	GROUP	CABLE TYPES
02	RG178, RG196, M17/93, M17/169	05	RG178DS, RG196DS	19	RG174DS, RG316DS, M17/151, M17/152, Times RD-316
03	RG174, RG179, RG316, M17/113, M17/119, M17/172, M17/189	10	.085" semi-rigid, RG405, M17/133	21	.056" semi-rigid
		11	.047" semi-rigid, M17/151		

SSMB Bulkhead Mounted Receptacles

Straight Bulkhead Jack Receptacles (.093" max panel thickness)

Rear mount

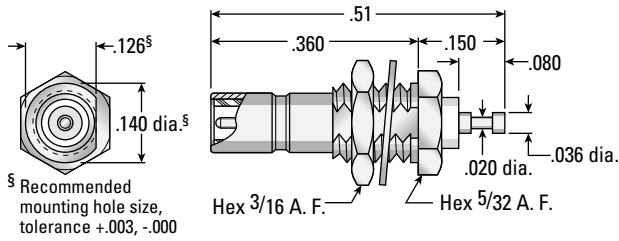

AEP P/N
7204-1511-000

Front mount

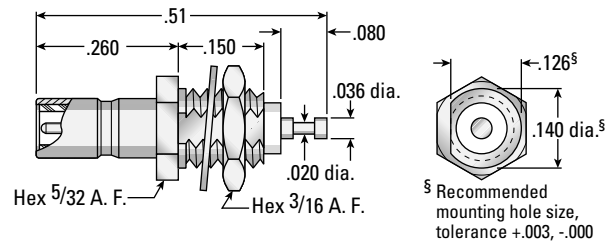

AEP P/N
7219-1511-000

Right Angle Bulkhead Receptacles (.093" max panel thickness)

Jack type

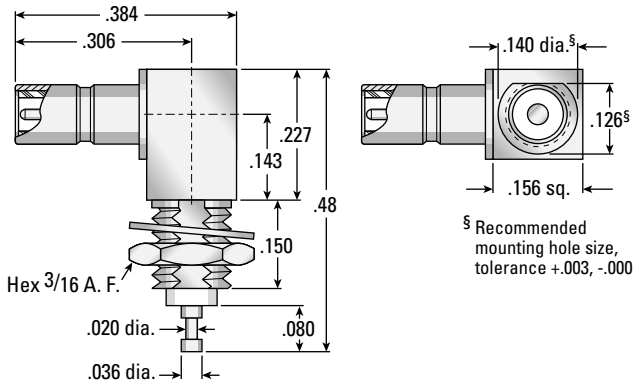

AEP P/N
7212-1511-000

Plug type

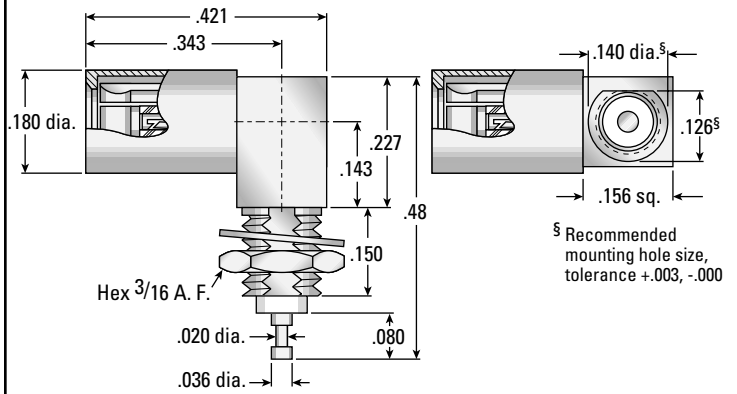

AEP P/N
7240-1511-000

Straight Bulkhead Plug Receptacles

Front mount
(.093" max panel thickness)

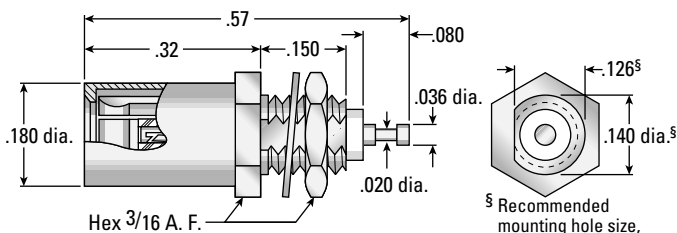

AEP P/N
7217-1512-000

Recessed mount
(.200" max panel thickness)

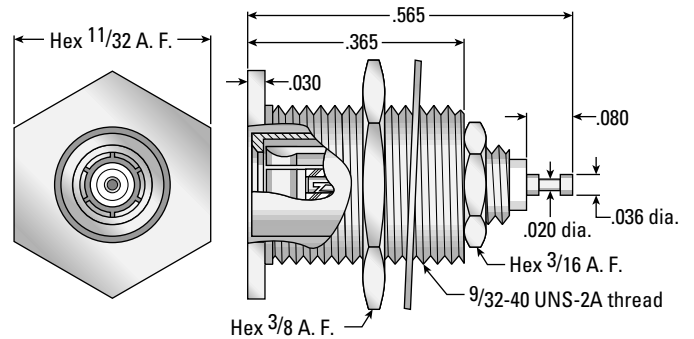

AEP P/N
7496-1512-000

SSMB P.C. Board Receptacles

Straight P.C. Board Receptacles

Standard legs

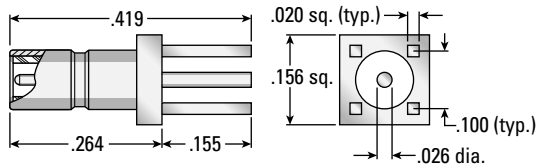

LEG FINISH	AEP P/N	LEG FINISH	AEP P/N
GOLD	7209-1511-000	PRETINNED	7209-1511-012

Standoff legs

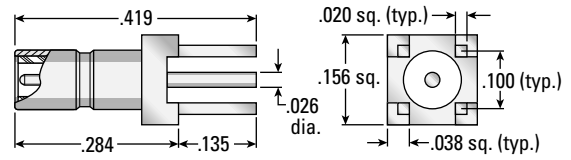

LEG FINISH	AEP P/N	LEG FINISH	AEP P/N
GOLD	7209-1511-050	PRETINNED	7209-1511-040

Surface mount

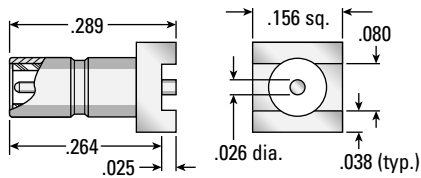

LEG FINISH	AEP P/N
GOLD	7209-1511-015

Edge mount

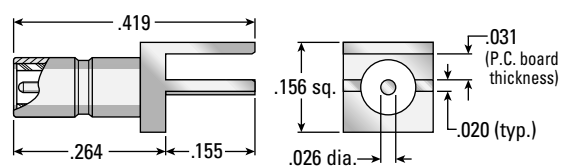

LEG FINISH	AEP P/N
GOLD	7209-1511-060

Right Angle P.C. Board Receptacles

Standard legs

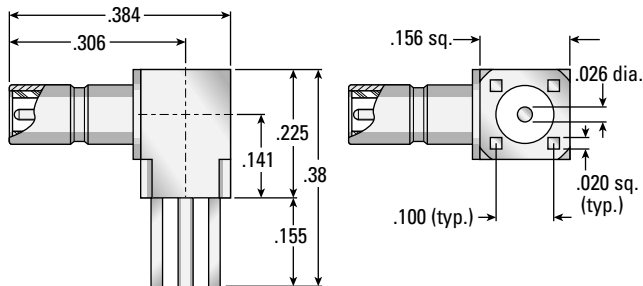

LEG FINISH	AEP P/N	LEG FINISH	AEP P/N
GOLD	7210-1511-000	PRETINNED	7210-1511-012

Standoff legs

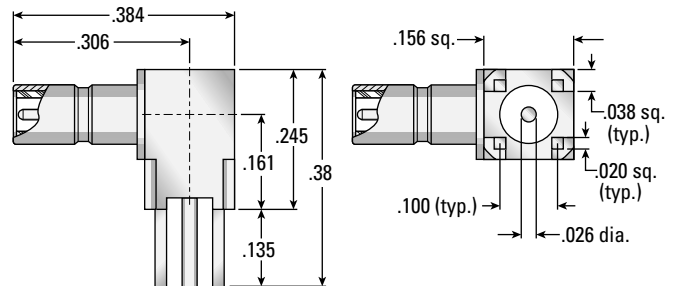

LEG FINISH	AEP P/N	LEG FINISH	AEP P/N
GOLD	7210-1511-050	PRETINNED	7210-1511-040

Surface mount

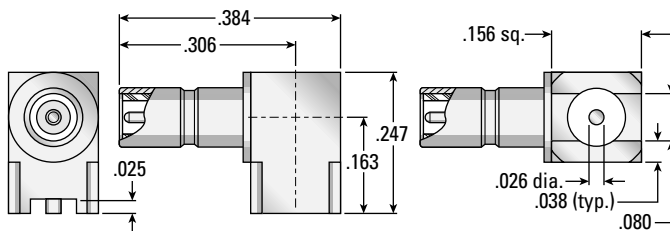

LEG FINISH	AEP P/N
GOLD	7210-1511-015

Edge mount

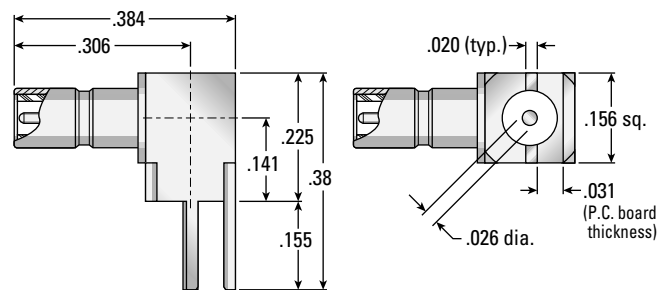

LEG FINISH	AEP P/N
GOLD	7210-1511-060

See page 4 for more information on P.C. board connectors with standoff legs, pretinned legs, and surface mount configurations.

SSMB P.C. Board Receptacles

Straight Bulkhead Mounted P.C. Board Receptacles (.125" max panel thickness)

Standard legs

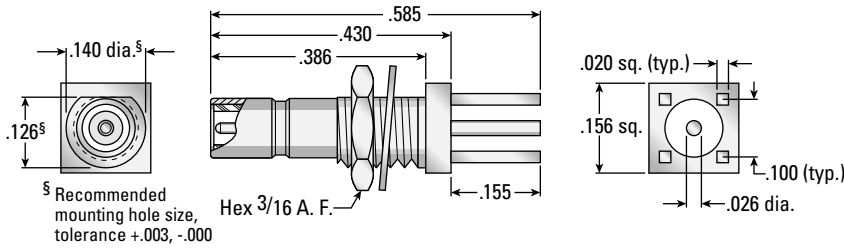

LEG FINISH	AEP P/N
GOLD	7229-1511-000
PRETINNED	7229-1511-012

Standoff legs

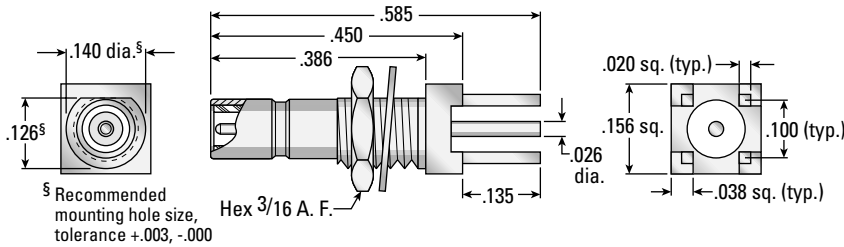

LEG FINISH	AEP P/N
GOLD	7229-1511-050
PRETINNED	7229-1511-040

Surface mount

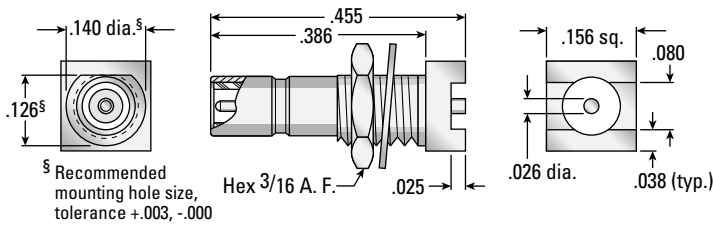

LEG FINISH	AEP P/N
GOLD	7229-1511-015

Edge mount

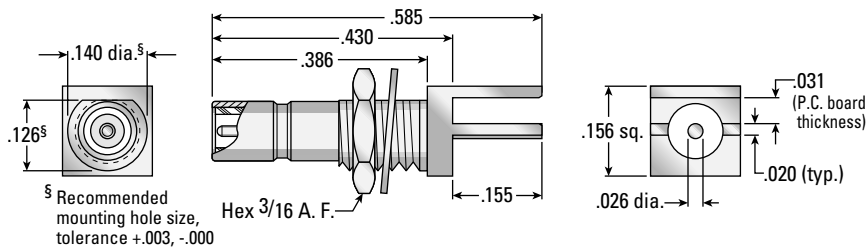

LEG FINISH	AEP P/N
GOLD	7229-1511-060

See page 4 for more information on P.C. board connectors with standoff legs, pretinned legs, and surface mount configurations.



APPLIED ENGINEERING PRODUCTS

(203) 776-2813 • FAX (203) 776-8294

www.aepconnectors.com • aepsales@aepconnectors.com

SSMB P.C. Board Receptacles

Right Angle Bulkhead Mounted P.C. Board Receptacles (.125" max panel thickness)

Standard legs

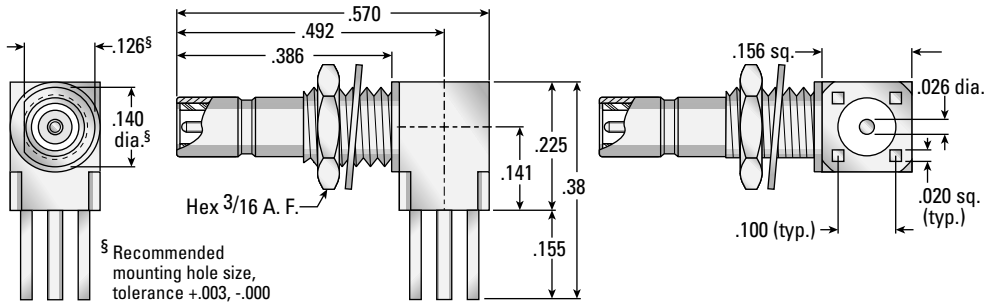

LEG FINISH	AEP P/N
GOLD	7410-1511-000
PRETINNED	7410-1511-012

Standoff legs

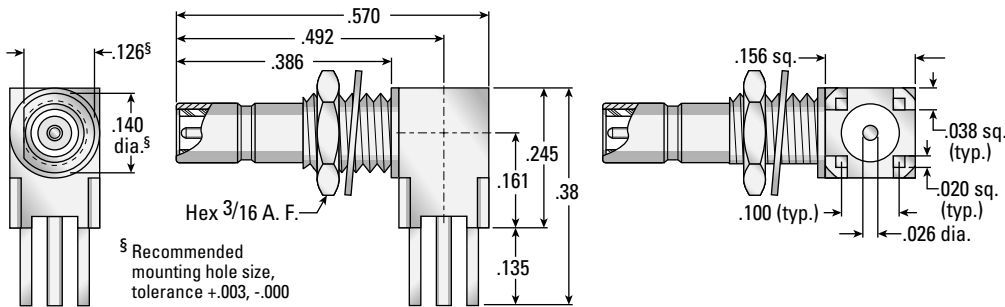

LEG FINISH	AEP P/N
GOLD	7410-1511-050
PRETINNED	7410-1511-040

Surface mount

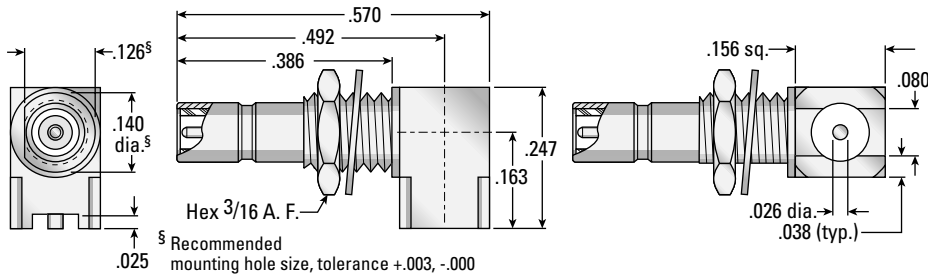

LEG FINISH	AEP P/N
GOLD	7410-1511-015

Edge mount

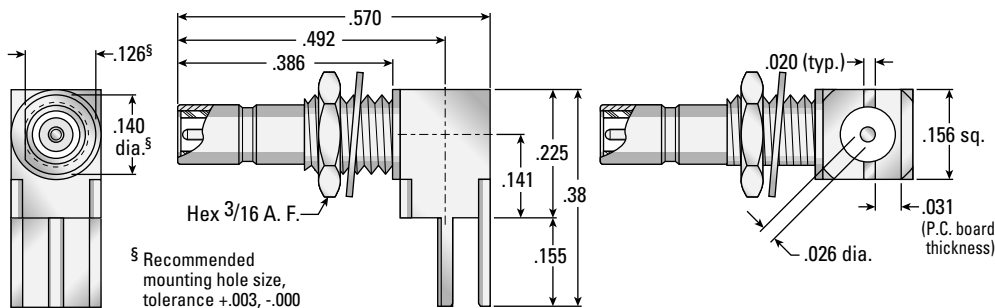

LEG FINISH	AEP P/N
GOLD	7410-1511-060



SSMB P.C. Board Receptacles

Straight Plug Type P.C. Board Receptacles

Standard legs

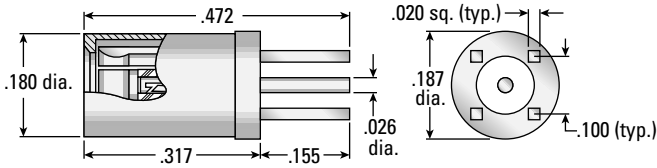

LEG FINISH	AEP P/N	LEG FINISH	AEP P/N
GOLD	7225-1512-000	PRETINNED	7225-1512-012

Standoff legs

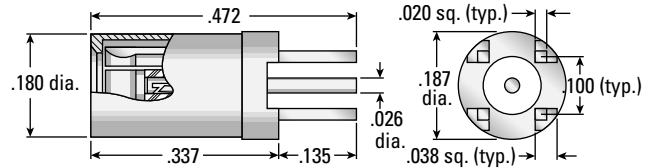

LEG FINISH	AEP P/N	LEG FINISH	AEP P/N
GOLD	7225-1512-050	PRETINNED	7225-1512-040

Surface mount

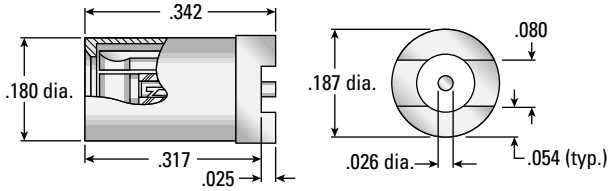

LEG FINISH	AEP P/N
GOLD	7225-1512-015

Edge mount

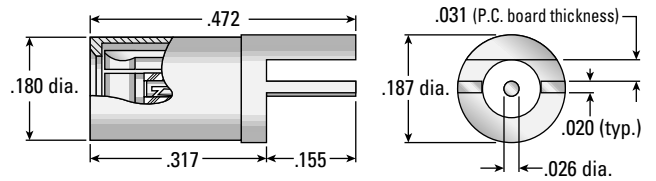

LEG FINISH	AEP P/N
GOLD	7225-1512-060

Right Angle Plug Type P.C. Board Receptacles

Standard legs

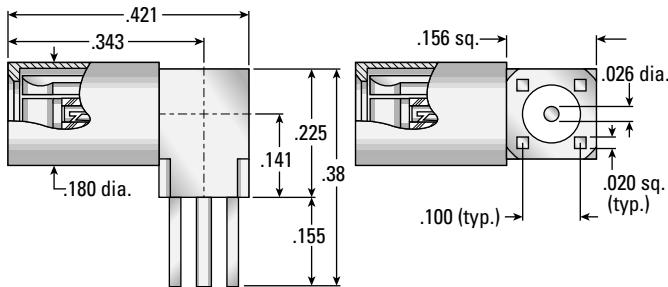

LEG FINISH	AEP P/N	LEG FINISH	AEP P/N
GOLD	7242-1511-000	PRETINNED	7242-1511-012

Standoff legs

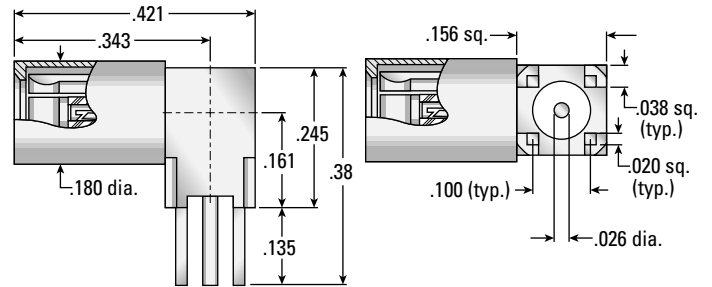

LEG FINISH	AEP P/N	LEG FINISH	AEP P/N
GOLD	7242-1511-050	PRETINNED	7242-1511-040

Surface mount

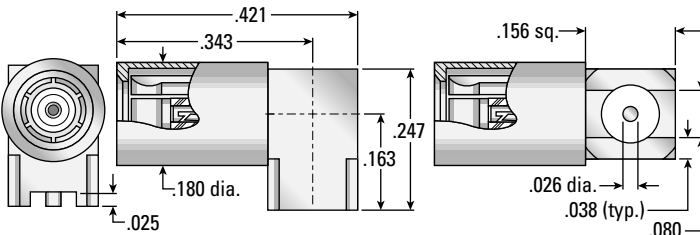

LEG FINISH	AEP P/N
GOLD	7242-1511-015

Edge mount

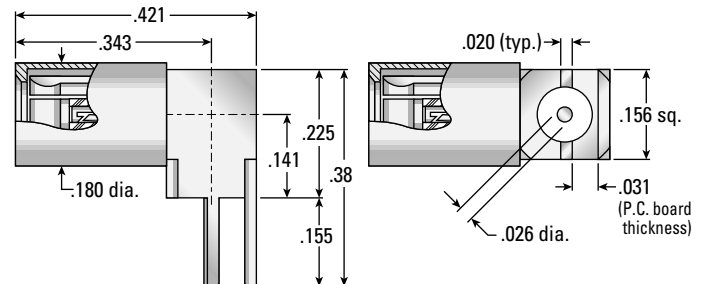

LEG FINISH	AEP P/N
GOLD	7242-1511-060

SSMB Receptacles and Adapters

Straight Panel Jack Receptacle (Stainless steel bodies)

4-hole flange

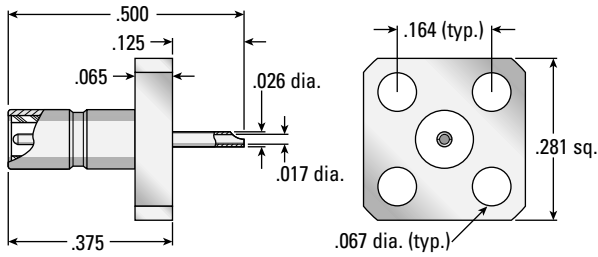

AEP P/N
7498-1513-000

2-hole flange

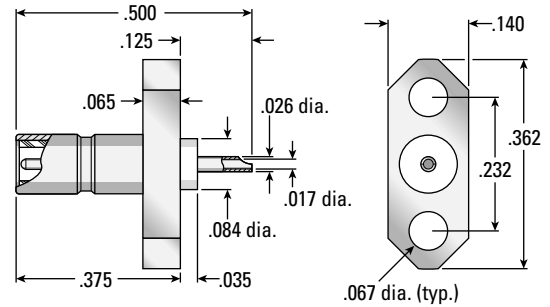

AEP P/N
7499-1513-000

Bulkhead Mounted Adapters

SSMB jack to SSMB jack

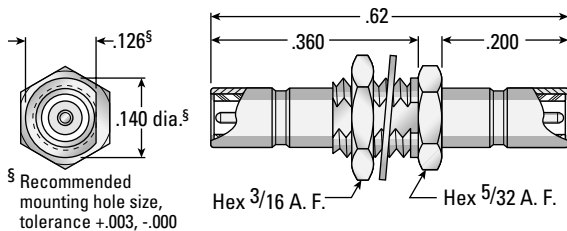

§ Recommended mounting hole size, tolerance +.003, -.000

AEP P/N
7222-1501-000

SSMC jack to SSMB jack

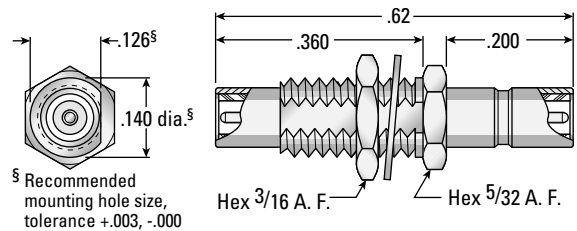

§ Recommended mounting hole size, tolerance +.003, -.000

AEP P/N
7022-1502-000

Adapters Between Series

N plug to SSMB jack

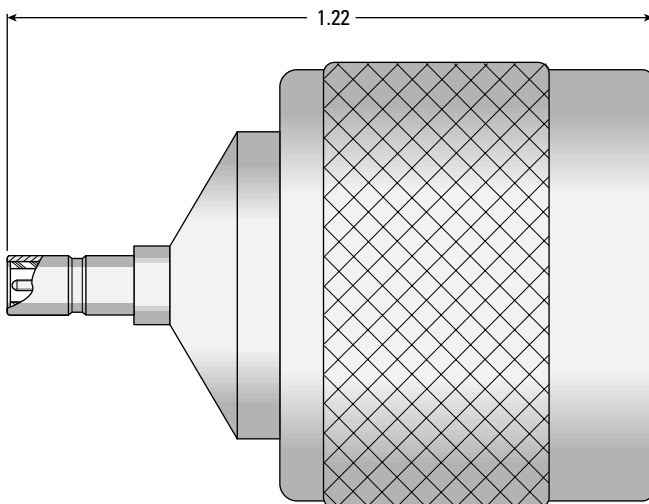

AEP P/N
5011-1503-000

SMA plug to SSMB jack

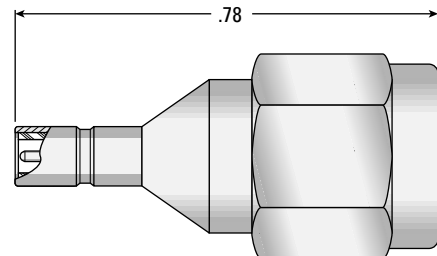

AEP P/N
5937-1503-000

Cable Assembly Instructions

Straight Connectors—Flexible Cable

Parts list

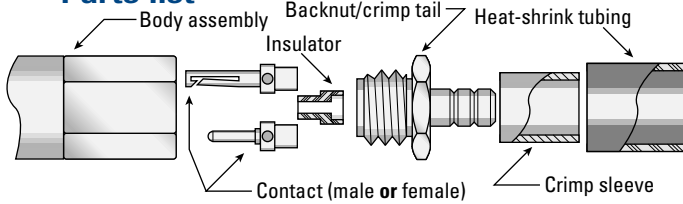

1

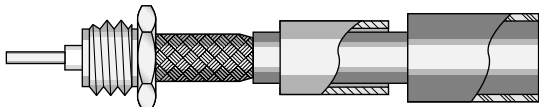

- Trim cable per trim code below; tin end of center conductor.
- Slide heat-shrink tubing and crimp sleeve over cable.
- Flare cable braid by rotating dielectric and slide cable into crimp tail.

2

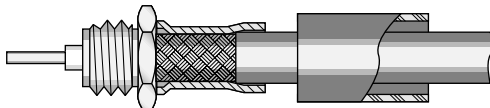

- Position cable so braid touches rear of back nut.
- Slide crimp sleeve forward to touch rear of back nut.
- Crimp braid with appropriate die size from chart below.

3

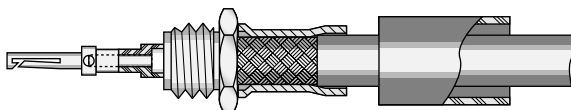

- Assemble insulator and contact onto cable dielectric and center conductor.
- Solder contact to center conductor by heating rear of contact (do not feed additional solder through inspection hole in contact).

4

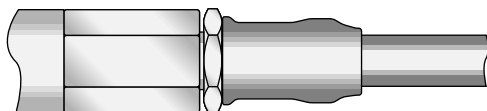

- Insert cable assembly into body assembly. Tighten to 25–45 inch-ounces torque.
- Slide shrink tubing over crimp sleeve and shrink to fit.

Cable Trim Dimensions

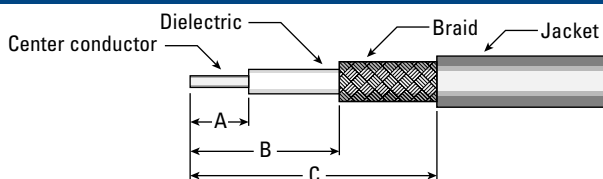

CONNECTOR TYPE	A	B	C
STRAIGHT CONNECTORS	.125	.300	.490
STRAIGHT P.C. BOARD TERMINATIONS	.060	.100	.230
RIGHT ANGLE CONNECTORS	.050	.100	.250

Right Angle Connectors—Flexible Cable

Parts list

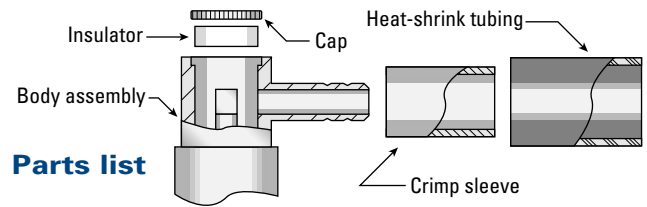

1

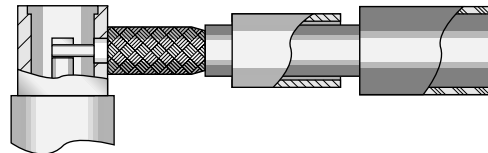

- Trim cable per trim code below; tin end of center conductor.
- Slide heat-shrink tubing and crimp sleeve over cable.
- Flare cable braid by rotating dielectric and slide cable into crimp tail.

2

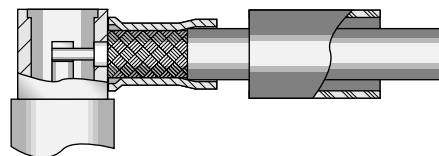

- Position cable so braid touches rear of body assembly.
- Slide crimp sleeve forward to touch rear of body assembly.
- Crimp braid with appropriate die size from chart below.

3

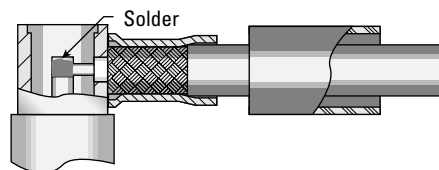

- Solder center conductor into notch in rear of contact with .025–.032" diameter chisel-tip soldering iron.
- Solder should cover center conductor, but not extend over top of notch in contact, or exceed contact diameter.

4

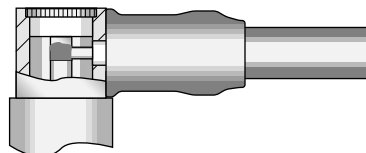

- Place insulator in body cavity, and press cap into place. Properly assembled cap will be slightly below end of body assembly.
- Slide shrink tubing over crimp sleeve and shrink to fit.

Crimp Die Sizes

CABLE GROUP	HEX DIE SIZE
02	.105
03	.128
05	.128
19	.128

Cable Assembly Instructions

Straight Connectors—Semi-Rigid Cable

Parts list

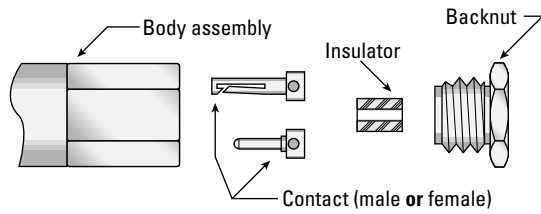

1

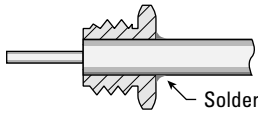

- Trim cable per trim code below; tin end of center conductor.
- Insert cable into backnut until trimmed end of jacket is flush with front of back nut.
- Solder cable jacket to back nut. Retrim dielectric flush if necessary.

2

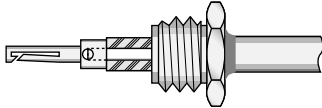

- Assemble insulator and contact onto cable dielectric and center conductor.
- Solder contact to center conductor by heating rear of contact (do not feed additional solder through inspection hole in contact).

3

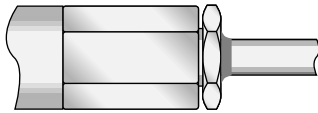

- Insert cable assembly into body assembly. Tighten to 25–45 inch-ounces torque.

Right Angle Connectors—Semi-Rigid Cable

Parts list

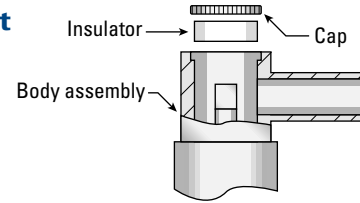

1

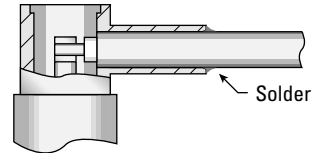

- Trim cable per trim code below; tin end of center conductor.
- Insert trimmed cable into body until jacket bottoms on step inside body and center conductor is in contact slot.
- Solder cable jacket to body assembly.

2

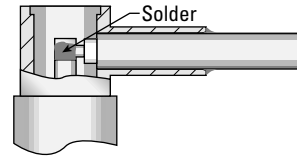

- Solder center conductor into notch in rear of contact with .025–.032" diameter chisel-tip soldering iron.
- Solder should cover center conductor, but not extend over top of notch in contact, or exceed contact diameter.

3

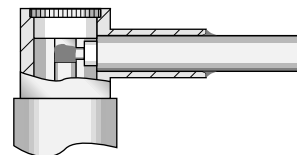

- Place insulator in body cavity, and press cap into place. Properly assembled cap will be slightly below end of body assembly.

Cable Trim Dimensions

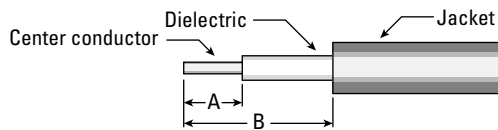

CONNECTOR TYPE	A	B
STRAIGHT CONNECTORS	.125	.125
RIGHT ANGLE CONNECTORS	.060	.120

Assembly Tools

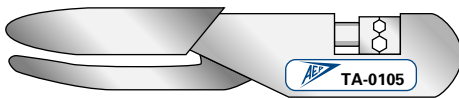

DESCRIPTION	AEP P/N
Crimp tool with .105" and .128" hex dies	TA-0105



DESCRIPTION	AEP P/N
Torque wrench with 5/32" jaws for SSMC plug coupling nuts and straight connector backnuts; 30 inch-ounces torque	TA-0432

DESCRIPTION	AEP P/N
Capping tool (arbor press) with bases for SSMB/SSMC/SSLB right angle plugs and jacks	CP-17

