

RevNo	Revision note	Date	Signature	Checked
B	REVISED THE TITLE BLOCK	04-24-12		
C	PACKAGE SPEC ADDED	07-25-14		

NOTES:

1. MATERIALS :
- OUTER SHELL : BRASS, T=0.30mm
 - HOUSING : PBT, UL 94V-0
 - BACK COVER : PBT, UL 94V-0
 - 4P CONTACT : PH. BRONZE, T=0.25mm
 - 5P CONTACT : BRASS, T=0.20mm
2. ELECTRICAL :
- INSULATION RESISTANCE : 100 Mohm MIN.
 - CONTACT RESISTANCE : 30 mohm MAX.
 - DIELECTRIC WITHSTANDING VOLTAGE : 100 VAC FOR 1 MINUTE
 - CURRENT RATING : 1.5A AT 250 VAC MIN.
3. MECHANICAL :
- MATING FORCE : 35N MAXIMUM
 - UNMATING FORCE : 10N MINIMUM
 - DURABILITY : 1500 CYCLES

PART NO. CODE:

U3B001 - 9 B X - X X
 ① ② ③ ④ ⑤ ⑥

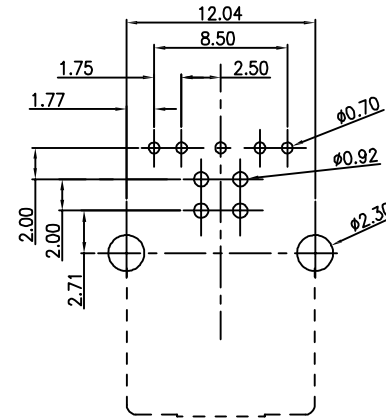
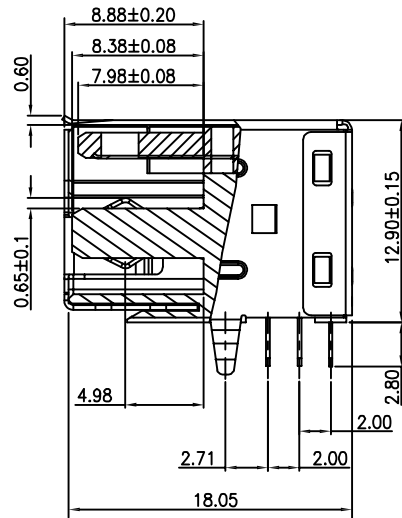
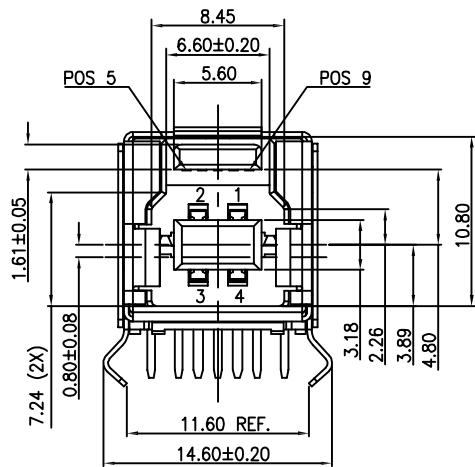
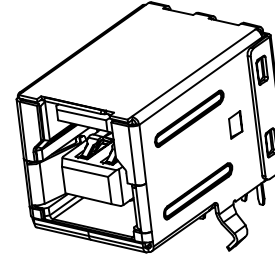
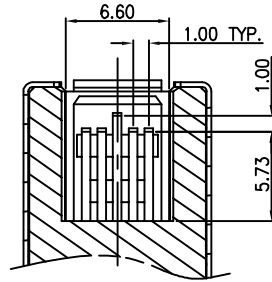
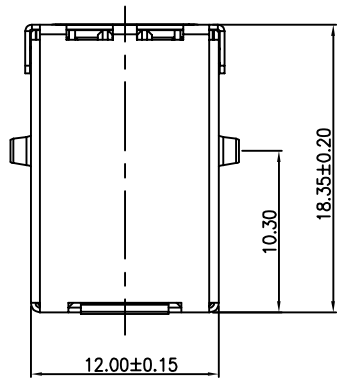

- ① SERIES:
 U3B001: USB 3.0 CONNECTOR, SERIES B, RIGHT ANGLE DIP TYPE
- ② POSITIONS:
 9: 9 POSITIONS
- ③ INSULATOR COLOR:
 K: BLACK
 W: WHITE
 B: BLUE
- ④ CONTACT PLATING:
 1: Au 1u"
 2: Au 3~5u"
 4: Au 15u"
 5: Au 30u"
- ⑤ ENVIRONMENT:
 O: RoHS
 H: HALOGEN FREE
- ⑥ WAY OF PACKING:
 T: TRAY
 R: TAPE & REEL
 B: WATERPROOF BAG



PCB LAYOUT (T=1.60mm)

BILL OF MATERIAL :

ITEM	PART NAME	Q'TY/EA	MATERIAL	PLATING
6	OUTER SHELL	1	BRASS	NICKEL
5	BACK COVER	1	PBT	N/A
4	HOUSING	1	PBT	N/A
3	HOUSING + CON	1	PBT + BRASS	N/A
2	LONG CONTACT	2	PHOSPHOR BRONZE	GOLD & TIN
1	SHORT CONTACT	2	PHOSPHOR BRONZE	GOLD & TIN

GENERAL TOLERANCES (UNLESS SPECIFIED) DIMENSION STYLE : MM < INCH >	FINISH	SEE NOTES																			
	MATERIAL	SEE NOTES																			
<table border="1"> <thead> <tr> <th></th> <th>MM</th> <th>ANGLE°</th> </tr> </thead> <tbody> <tr> <td>4 PLACES</td> <td>± ---</td> <td>± ---</td> </tr> <tr> <td>3 PLACES</td> <td>± 0.05</td> <td>± ---</td> </tr> <tr> <td>2 PLACES</td> <td>± 0.13</td> <td>± 0.5°</td> </tr> <tr> <td>1 PLACES</td> <td>± 0.25</td> <td>± 1.0°</td> </tr> <tr> <td>0 PLACES</td> <td>± 0.38</td> <td>± 2.0°</td> </tr> </tbody> </table>		MM	ANGLE°	4 PLACES	± ---	± ---	3 PLACES	± 0.05	± ---	2 PLACES	± 0.13	± 0.5°	1 PLACES	± 0.25	± 1.0°	0 PLACES	± 0.38	± 2.0°	DRAWN BY R. Ly	DATE 04-24-12	TITLE USB 3.0, 9P, SERIES B, FEMALE, RIGHT ANGLE, THRU-HOLE TYPE
	MM	ANGLE°																			
4 PLACES	± ---	± ---																			
3 PLACES	± 0.05	± ---																			
2 PLACES	± 0.13	± 0.5°																			
1 PLACES	± 0.25	± 1.0°																			
0 PLACES	± 0.38	± 2.0°																			
	CHECKED BY A. TENG	DATE 04-24-12	SIZE A4																		
 THIRD ANGLE PROJECTION	APPROVED BY ---	DATE ---	DRAWING NO. U3B001-9BX-XX																		
	SCALE	NONE	SHEET 1 OF 2																		
			REV. C																		

RevNo	Revision note	Date	Signature	Checked
B	REVISED THE TITLE BLOCK	04-24-12		
C	PACKAGE SPEC ADDED	07-25-14		

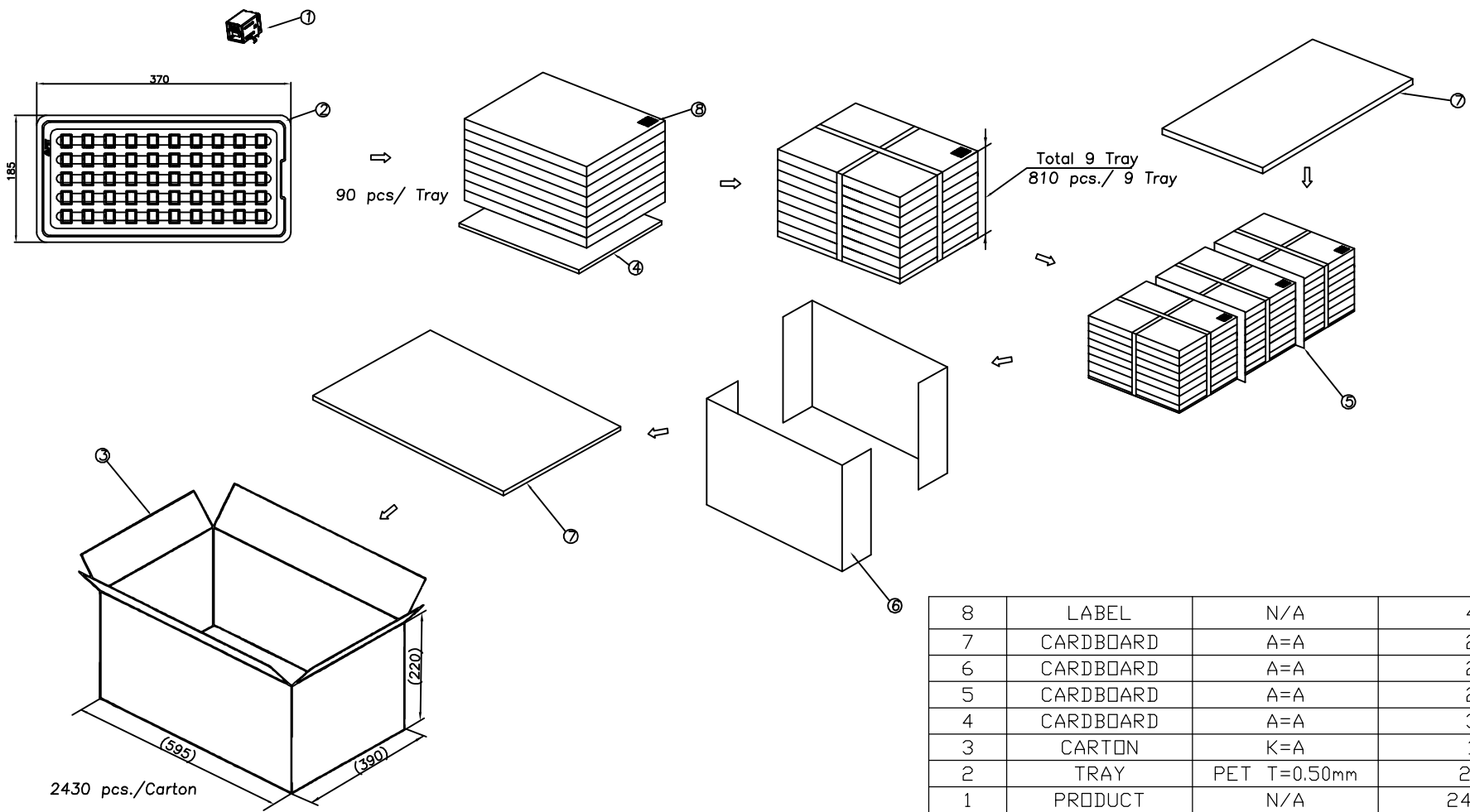

Total 9 Tray
810 pcs./ 9 Tray

2430 pcs./Carton

8	LABEL	N/A	4
7	CARDBOARD	A=A	2
6	CARDBOARD	A=A	2
5	CARDBOARD	A=A	2
4	CARDBOARD	A=A	3
3	CARTON	K=A	1
2	TRAY	PET T=0.50mm	27
1	PRODUCT	N/A	2430
ITEM	PART NAME	MATERIAL	QUANTITY (PCS)

NOTES:

- PACKING QUANTITY AND STYLE:
1) QUANTITY: 90PCS/TRAY, 27 TRAYS/CARTON,
TOTAL : 2430PCS/CARTON
2) PACKING STYLE: TRAY

GENERAL TOLERANCES (UNLESS SPECIFIED) DIMENSION STYLE : MM (INCH)	FINISH			
	SEE NOTES			
	MATERIAL		TITLE USB 3.0, 9P, SERIES B, FEMALE, RIGHT ANGLE, THRU-HOLE TYPE	
	SEE NOTES			
4 PLACES ± --- ± ---	DRAWN BY	DATE	SIZE	DRAWING NO.
3 PLACES ± 0.05 ± ---	A. TENG	07-25-14	A4	U3B001-9BX-XX
2 PLACES ± 0.13 ± 0.5°	CHECKED BY	DATE	SCALE	SHEET
1 PLACES ± 0.25 ± 1.0°	---	---	NONE	2 OF 2
0 PLACES ± 0.38 ± 2.0°	APPROVED BY	DATE		REV.
	---	---		C
	THIRD ANGLE PROJECTION			