

# SM CONNECTOR

*Disconnectable Crimp style wire-to-wire connectors*

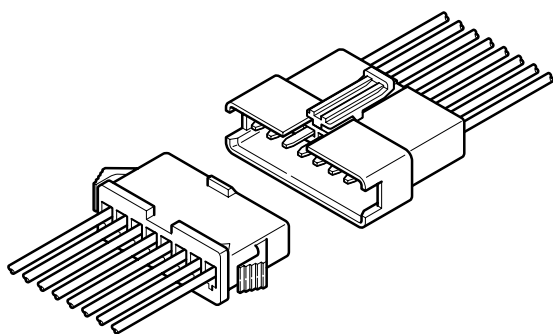

**The SM series are 2.5mm (.098") pitch, wire-to-wire connectors that perform reliably in high-density, small current applications.**



## Features

### • High contact pressure

With each insertion and withdrawal, the mating contacts wipe against each other to remove foreign matter. Moreover, the socket contacts tolerate a large variation in mating post thickness without a reduction in their normally high contact pressure. These factors insure an especially long service life. Moreover, the design of the housing and contacts allows the contacts to be easily inserted into the housing.

### • Highly reliable housing construction

Since all the contacts are individually and totally surrounded by housing walls, the contacts are protected from deformation from outside sources of stress or from mismatching. The polarized housing shape prevents reverse connection.

### • Mountable on a variety of panels

Due to our unique panel installation locking mechanisms, the housing can be easily installed on panels of various thicknesses without using tools.

### • Arm lock mechanism

An arm lock mechanism securely holds the plug and the receptacle together when they are connected.

## Specifications

- Current rating: 3.0A AC, DC max.
  - Voltage rating: 250V AC, DC max.
  - Temperature range: -25°C to +85°C  
(including temperature rise in applying electrical current)
  - Contact resistance: Initial value/10mΩ max.  
After environmental testing/20mΩ max.
  - Insulation resistance: 500MΩ min.
  - Withstanding voltage: 1,000V AC/minute
  - Applicable wire: AWG #28 to #22  
0.08 to 0.33mm<sup>2</sup>
  - Applicable panel thickness: 0.5 to 2.0mm(.020" to .079")
- \* Contact JST for details.

## Standards

Recognized file No. E60389

Certified file No. LR20812

File No. R75050 (conforms to DIN/VDE 0627)

**JST 505**

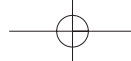

# SM CONNECTOR

## Contact

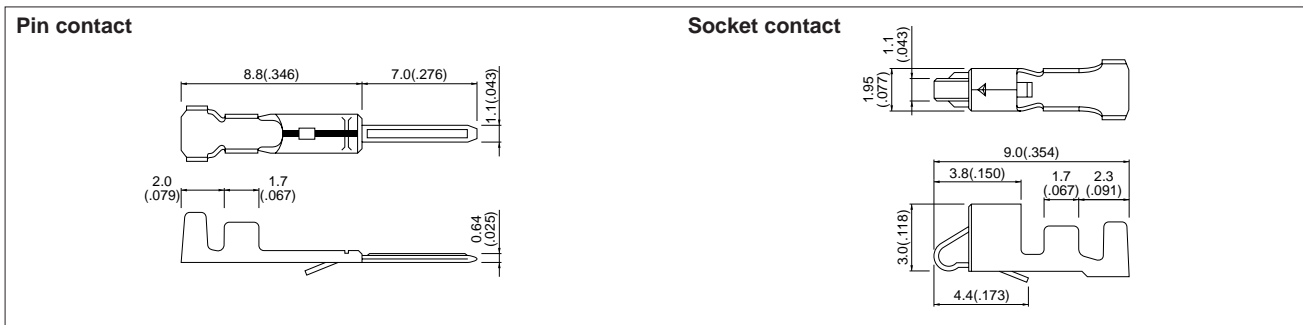

Model No.		Applicable wire			Q'ty / reel
Pin contact	Socket contact	mm <sup>2</sup>	AWG #	Insulation O.D. mm(in.)	
<b>SYM-001T-P0.6</b>	<b>SHF-001T-0.8BS</b>	0.08 to 0.33	28 to 22	1.2 to 1.8(.047 to .071)	Pin contact: 7,500 Socket contact: 5,000

**Material and Finish**  
 Phosphor bronze, tin-plated

Note:  
 1. Contact JST for special products.

## Housing

Material: Nylon6, UL94V-0

Circuits	Current rating	Receptacle housing(for pin contact)		Plug housing(for socket contact)	
		Model No. & Color	Q'ty / bag	Model No. & Color	Q'ty / bag
2	3.0A	<b>SMR-02V-B</b> , black <b>SMR-02V-N</b> , natural (white)	1,000	<b>SMP-02V-BC</b> , black <b>SMP-02V-NC</b> , natural (white)	1,000
3	3.0A	<b>SMR-03V-B</b> , black <b>SMR-03V-N</b> , natural (white)	1,000	<b>SMP-03V-BC</b> , black <b>SMP-03V-NC</b> , natural (white)	1,000
4	3.0A	<b>SMR-04V-B</b> , black <b>SMR-04V-N</b> , natural (white)	500	<b>SMP-04V-BC</b> , black <b>SMP-04V-NC</b> , natural (white)	1,000

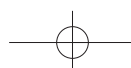

# SM CONNECTOR

## Housing

Material: Nylon6, UL94V-0

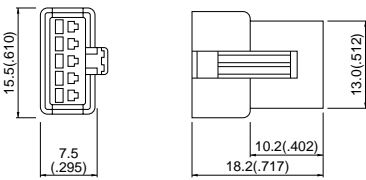
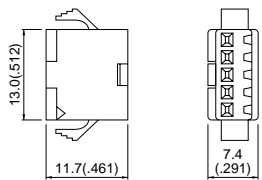
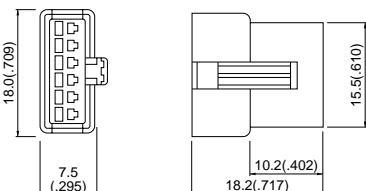
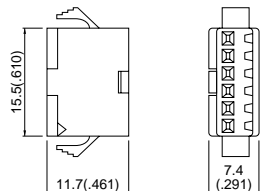
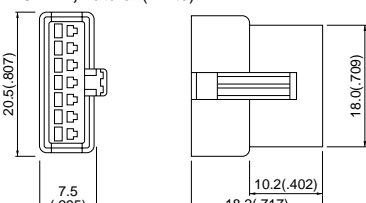
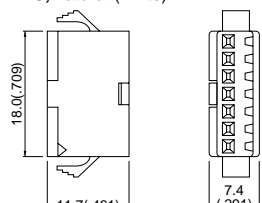
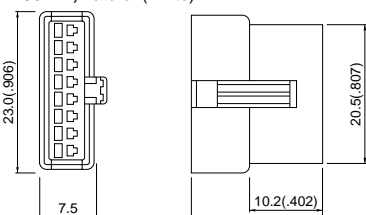
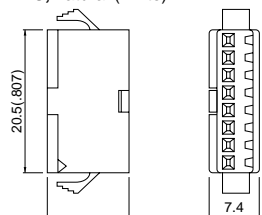
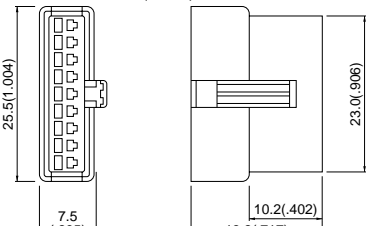
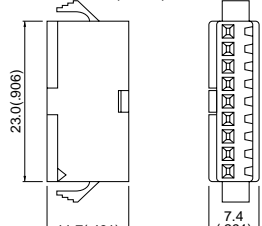
Circuits	Current rating	Receptacle housing(for pin contact)		Plug housing(for socket contact)		
5	3.0A	<b>SMR-05V-B</b> , black <b>SMR-05V-N</b> , natural (white)		Q'ty / bag	<b>SMP-05V-BC</b> , black <b>SMP-05V-NC</b> , natural (white)	Q'ty / bag
			500		1,000	
6	3.0A	<b>SMR-06V-B</b> , black <b>SMR-06V-N</b> , natural (white)		Q'ty / bag	<b>SMP-06V-BC</b> , black <b>SMP-06V-NC</b> , natural (white)	Q'ty / bag
			500		500	
7	3.0A	<b>SMR-07V-B</b> , black <b>SMR-07V-N</b> , natural (white)		Q'ty / bag	<b>SMP-07V-BC</b> , black <b>SMP-07V-NC</b> , natural (white)	Q'ty / bag
			500		500	
8	3.0A	<b>SMR-08V-B</b> , black <b>SMR-08V-N</b> , natural (white)		Q'ty / bag	<b>SMP-08V-BC</b> , black <b>SMP-08V-NC</b> , natural (white)	Q'ty / bag
			500		500	
9	3.0A	<b>SMR-09V-B</b> , black <b>SMR-09V-N</b> , natural (white)		Q'ty / bag	<b>SMP-09V-BC</b> , black <b>SMP-09V-NC</b> , natural (white)	Q'ty / bag
			500		500	

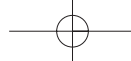

# SM CONNECTOR

## Housing

Material: Nylon6, UL94V-0

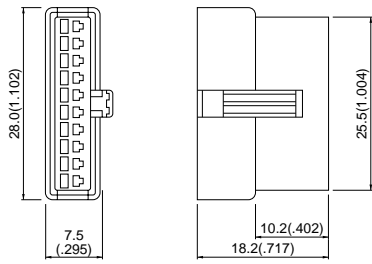
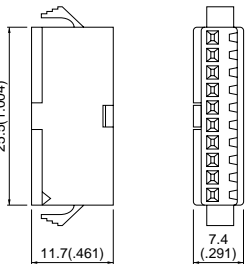
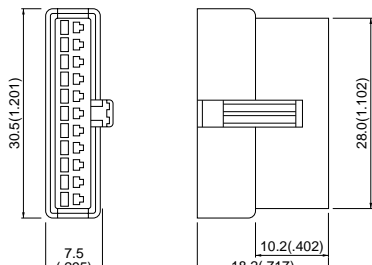
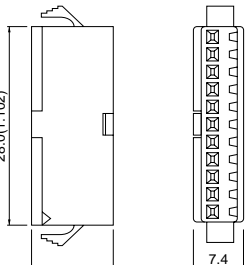
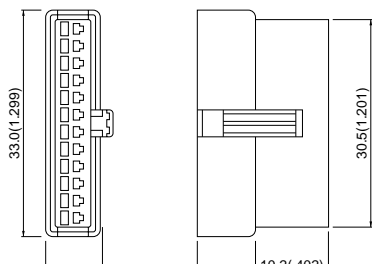
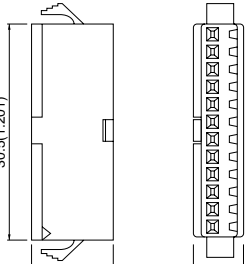
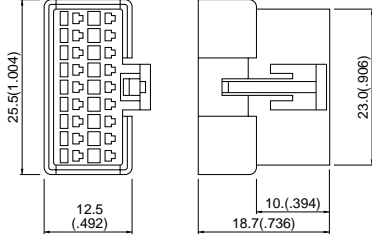
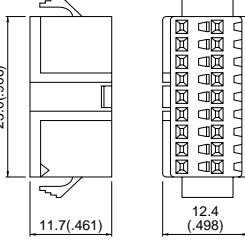
Circuits	Current rating	Receptacle housing(for pin contact)	Q'ty / bag	Plug housing(for socket contact)	Q'ty / bag
10	3.0A	<p><b>SMR-10V-B</b>, black <b>SMR-10V-N</b>, natural (white)</p>  <p>Dimensions: 28.0(1.102) height, 7.5(.295) width, 10.2(.402) pin length, 18.2(.717) body length, 25.5(1.004) total length.</p>	200	<p><b>SMP-10V-BC</b>, black <b>SMP-10V-NC</b>, natural (white)</p>  <p>Dimensions: 25.5(1.004) height, 11.7(.461) width, 7.4(.291) pin length.</p>	500
11	3.0A	<p><b>SMR-11V-B</b>, black <b>SMR-11V-N</b>, natural (white)</p>  <p>Dimensions: 30.5(1.201) height, 7.5(.295) width, 10.2(.402) pin length, 18.2(.717) body length, 28.0(1.102) total length.</p>	200	<p><b>SMP-11V-BC</b>, black <b>SMP-11V-NC</b>, natural (white)</p>  <p>Dimensions: 28.0(1.102) height, 11.7(.461) width, 7.4(.291) pin length.</p>	500
12	3.0A	<p><b>SMR-12V-B</b>, black <b>SMR-12V-N</b>, natural (white)</p>  <p>Dimensions: 33.0(1.299) height, 7.5(.295) width, 10.2(.402) pin length, 18.2(.717) body length, 30.5(1.201) total length.</p>	200	<p><b>SMP-12V-BC</b>, black <b>SMP-12V-NC</b>, natural (white)</p>  <p>Dimensions: 30.5(1.201) height, 11.7(.461) width, 7.4(.291) pin length.</p>	500
18	2.0A	<p><b>SMR-18V-B</b>, black <b>SMR-18V-N</b>, natural (white)</p>  <p>Dimensions: 25.5(1.004) height, 12.5(.492) width, 10(.394) pin length, 18.7(.736) body length, 23.0(.906) total length.</p>	200	<p><b>SMP-18V-BC</b>, black <b>SMP-18V-NC</b>, natural (white)</p>  <p>Dimensions: 23.0(.906) height, 11.7(.461) width, 12.4(.498) pin length.</p>	500

Note:  
 1. SM connectors with any number of circuits can be either panel mounted or free hanging.  
 2. Contact JST for special products.

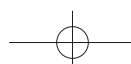

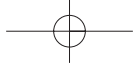

# SM CONNECTOR

## Contact position location numbers

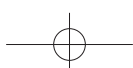
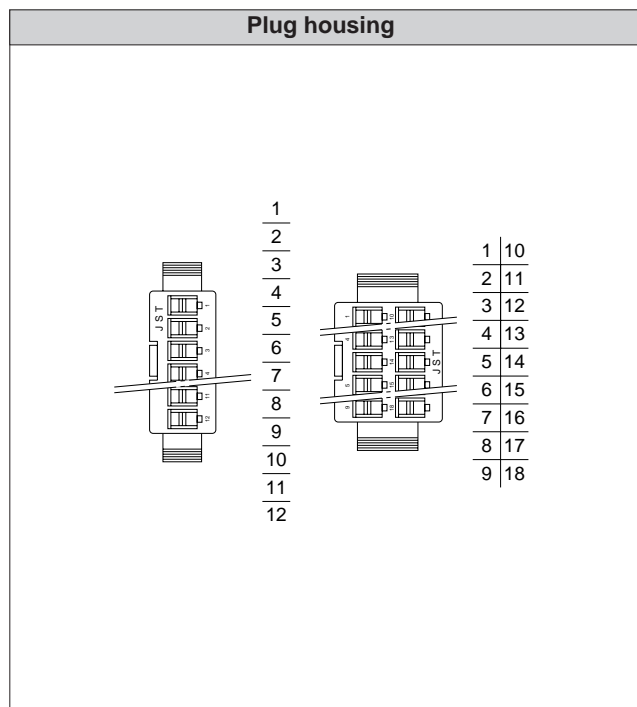
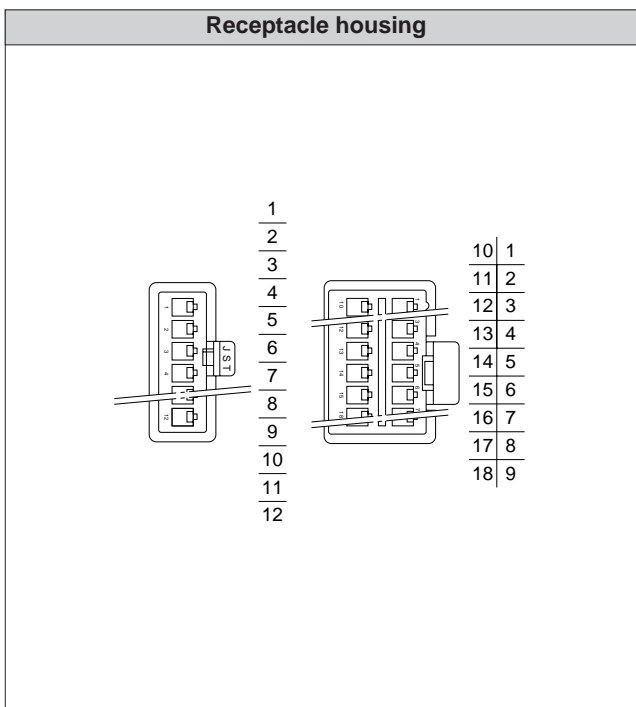
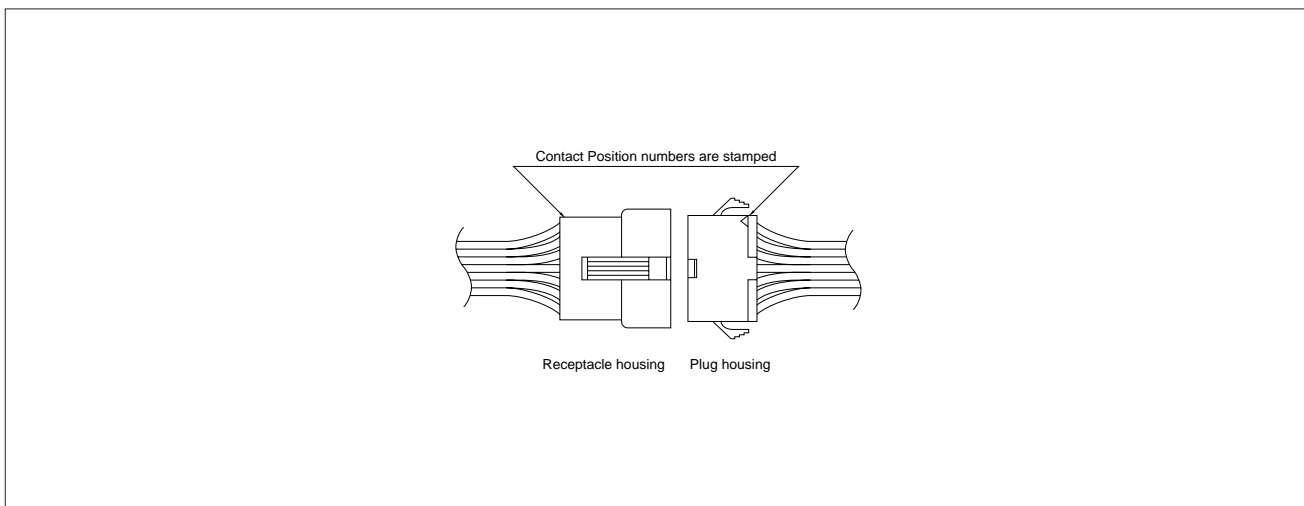

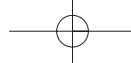

# SM CONNECTOR

## Panel layout

(2 to 12 circuits)

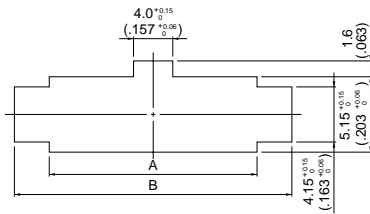

(18 circuits)

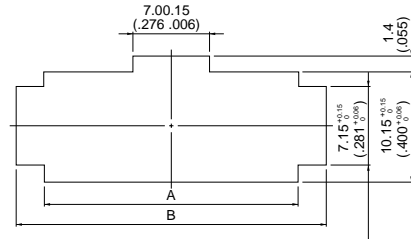

Circuits	Housing Model No.	Panel thickness mm(in.)					
		0.5 to 0.9(.020 to .035)		1.0 to 1.5(.039 to .059)		1.5 to 2.0(.059 to .079)	
		$A \begin{smallmatrix} \pm 0.15 \\ 0 \end{smallmatrix} (\pm .006)$	$B \pm 0.1 (\pm .004)$	$A \begin{smallmatrix} \pm 0.15 \\ 0 \end{smallmatrix} (\pm .006)$	$B \pm 0.1 (\pm .004)$	$A \begin{smallmatrix} \pm 0.15 \\ 0 \end{smallmatrix} (\pm .006)$	$B \pm 0.1 (\pm .004)$
2	<b>SMP-02V-B(N)C</b>	5.7( .224)	9.6( .378)	5.7( .224)	9.8( .386)	5.7( .224)	10.0( .394)
3	<b>SMP-03V-B(N)C</b>	8.2( .323)	12.1( .476)	8.2( .323)	12.3( .484)	8.2( .323)	12.5( .492)
4	<b>SMP-04V-B(N)C</b>	10.7( .421)	14.6( .575)	10.7( .421)	14.8( .583)	10.7( .421)	15.0( .591)
5	<b>SMP-05V-B(N)C</b>	13.2( .520)	17.1( .673)	13.2( .520)	17.3( .681)	13.2( .520)	17.5( .689)
6	<b>SMP-06V-B(N)C</b>	15.7( .618)	19.6( .772)	15.7( .618)	19.8( .780)	15.7( .618)	20.0( .787)
7	<b>SMP-07V-B(N)C</b>	18.2( .717)	22.1( .870)	18.2( .717)	22.3( .878)	18.2( .717)	22.5( .886)
8	<b>SMP-08V-B(N)C</b>	20.7( .815)	24.6( .969)	20.7( .815)	24.8( .976)	20.7( .815)	25.0( .984)
9	<b>SMP-09V-B(N)C</b>	23.2( .913)	27.1(1.067)	23.2( .913)	27.3(1.075)	23.2( .913)	27.5(1.083)
10	<b>SMP-10V-B(N)C</b>	25.7(1.012)	29.6(1.165)	25.7(1.012)	29.8(1.173)	25.7(1.012)	30.0(1.181)
11	<b>SMP-11V-B(N)C</b>	28.2(1.110)	32.1(1.264)	28.2(1.110)	32.3(1.272)	28.2(1.110)	32.5(1.280)
12	<b>SMP-12V-B(N)C</b>	30.7(1.209)	34.6(1.362)	30.7(1.209)	34.8(1.370)	30.7(1.209)	35.0(1.378)
18	<b>SMP-18V-B(N)C</b>	23.2( .913)	27.2(1.071)	23.2( .913)	27.4(1.079)	23.2( .913)	27.6(1.087)

**Note:**

1. Punch holes in the panel according to the sketch and table shown above. Burrs must be removed.
2. The strength of the panel must be considered when punching two or more holes.
3. The connector must be inserted from the same side as the hole is punched.

## Assembly layout

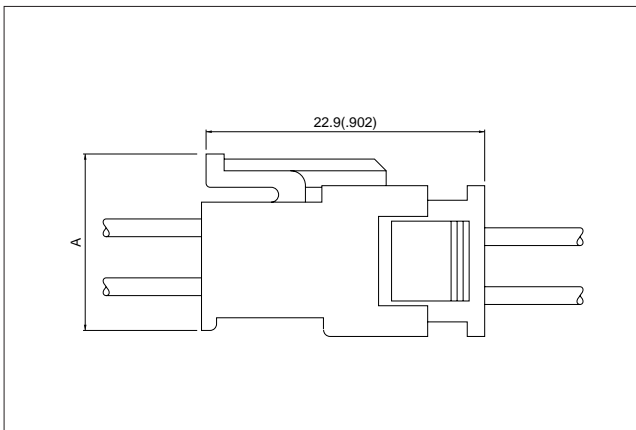

Circuits	Dimension A mm(in.)
2 to 12	8.7(.343)
18	14.5(.571)

