

01

0103

DIN circular connectors



DIN chassis socket, shielded, suitable for locking, metal housing, flange and solder terminals

01

0103

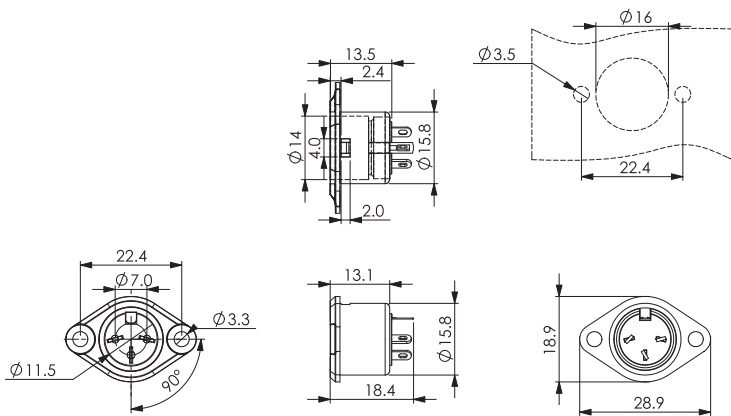

Pin configurations, solder side view

DIN 41524

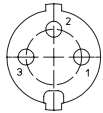

0103 03

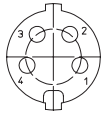

0103 04

DIN 41524

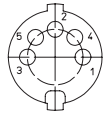

0103 05

DIN 45322

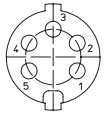

0103 05-1

DIN 45322

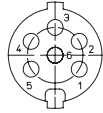

0103 06

DIN 45329

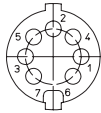

0103 07-1

DIN 45326

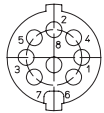

0103 08-1

Environmental conditions

Temperature range -25 °C/+80 °C

Materials

Insulating body PA, V-0 according to UL94
 Contact spring CuZn, silver-plated
 Ground contact spring Cu, nickel-plated
 Housing Zn alloy, nickel-plated

Mechanical data

Mating cycles 1000
 Insertion force ≤ 50 N
 Withdrawal force ≥ 5 N

Electrical data (at T_{amb} 20 °C)

Contact resistance ≤ 30 mΩ (contact spring)
 ≤ 50 mΩ (housing)
 Rated current ≤ 4 A
 Rated voltage 100 V AC
 Rated impulse voltage 250 V AC RMS/60 s
 Insulation resistance ≥ 100 MΩ

Associated products

Counterparts
 ↗ 0131 ↗ 0137

01

0103

Designation	Pole Number	PU (Pieces)	MDQ (Pieces)
0103 03	3	50	150
0103 04	4	50	150
0103 05	5	50	150
0103 05-1	5	50	150
0103 06	6	50	150
0103 08-1	8	50	150

Packaging:

in individual plastic bags, in a cardboard box