

01

0137

DIN circular connectors



DIN plug, straight version, shielded, with locking catch,
metal housing, bend protection and solder terminals

01

0137

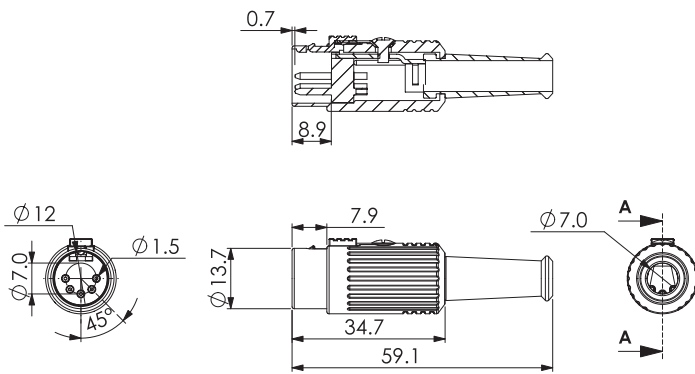

Environmental conditions

Temperature range -25 °C/+80 °C

Materials

Insulating body	PA, V-0 according to UL94
Contact pin	CuZn, silver-plated
Strain relief	steel, nickel-plated
Housing	Zn alloy, nickel-plated
Locking	Zn alloy, nickel-plated
Leaf spring	steel
Bend protection sleeve	PVC
Screw	steel, nickel-plated

Pin configurations, solder side view

DIN 41524

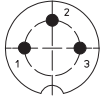

0137 03

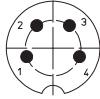

0137 04

DIN 41524

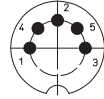

0137 05

DIN 45322

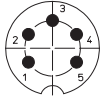

0137 05-1

DIN 45322

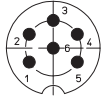

0137 06

DIN 45329

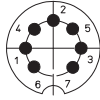

0137 07-1

DIN 45326

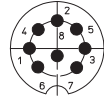

0137 08-1



Connectable conductors for solder area

Section	≤ AWG 19 (0.65 mm ²)
Cable diameter	7,0 mm

Electrical data (at T_{amb} 20 °C)

Rated current	4 A
Rated voltage	100 V AC
Rated impulse voltage	250 V AC RMS/60 s
Insulation resistance	≥ 100 MΩ

Associated products

Counterparts	 0103	 0105	 010599
--------------	--	--	--

01

0137

Designation	Pole Number	PU (Pieces)	MDQ (Pieces)
0137 03	3	50	150
0137 04	4	50	150
0137 05	5	50	150
0137 05-1	5	50	150
0137 06	6	50	150
0137 07-1	7	50	150
0137 08-1	8	50	150

Packaging:

in individual plastic bags, in a cardboard box