

AN1311, AN1311S

Single High-Speed Comparators

Overview

The AN1311 and the AN1311S are single high-speed voltage comparators with large output sink current, wide operating supply voltage range, and excellent characteristics for $\pm 15V$ operation as well as for 5V single power supply operation. They are provided with strobe pins and can be applied widely to drive the standard logic circuit directly.

Features

- The output levels are compatible with TTL and MOS logic.
- Offset balancing and strobe capability are available.
- Large output sink current drives LED and lamps.
- Output stage forms open collector and emitter follower.

Pin Descriptions

Pin No.	Pin name
1	GND
2	Non inverting input
3	Inverting input
4	V_{EE}
5	Balance
6	Balance/Strobe
7	Output
8	V_{CC}

Block Diagram

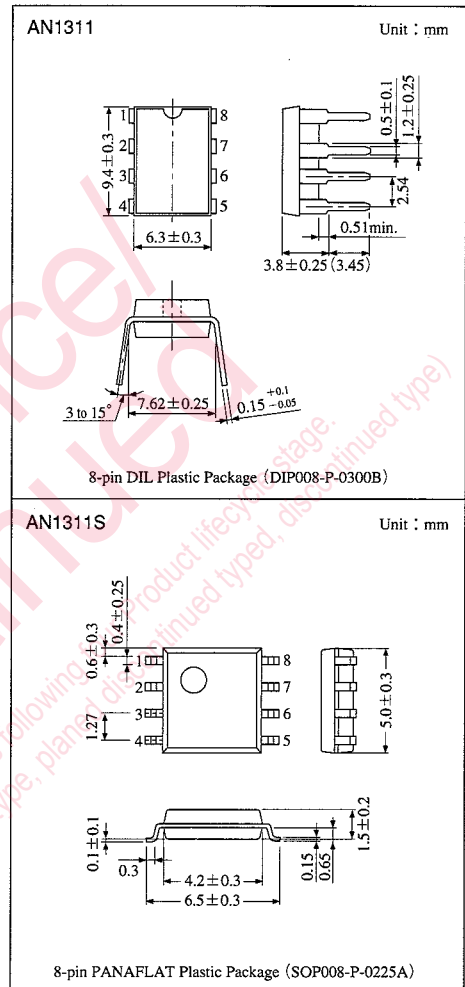
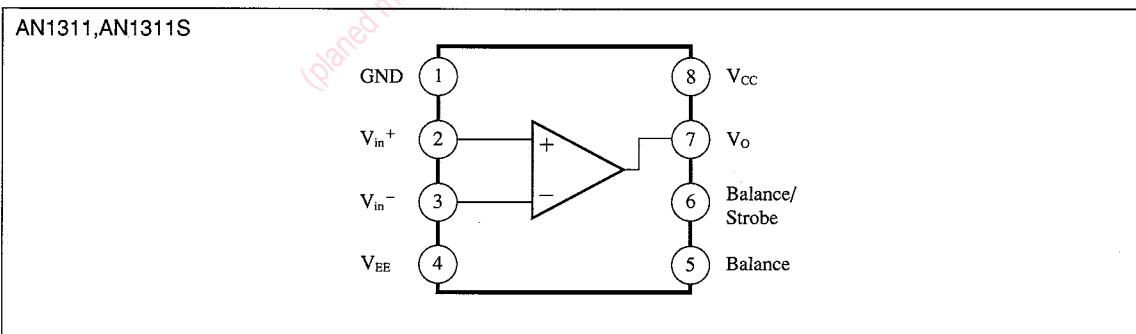

Comparators

Absolute Maximum Ratings ($T_a=25^{\circ}\text{C}$)

Parameter		Symbol	Rating	Unit
Voltage	Supply voltage	V_{CC}	± 18	V
	Differential input voltage	V_{ID}	± 30	V
	Common-mode input voltage	V_{ICM}	± 15	V
	Voltage between output and negative power supply	$V_O - V_{EE}$	36	V
	Voltage between ground and negative power supply	$V_{GND} - V_{EE}$	30	V
Output short-circuit duration		t_{OS}	10	s
Power dissipation	AN1311	P_D	500	mW
	AN1311S		360	
Operating ambient temperature		T_{opr}	-20 to +75	$^{\circ}\text{C}$
Storage temperature	AN1311	T_{stg}	-55 to +150	$^{\circ}\text{C}$
	AN1311S		-55 to +125	

Electrical Characteristics ($V_{CC}=15\text{V}$, $V_{EE}=-15\text{V}$, $T_a=25^{\circ}\text{C}$)

Parameter	Symbol	Condition	min	typ	max	Unit
Input offset voltage	$V_{I(\text{offset})}$	$R_S \leq 50\text{k}\Omega$	—	2.0	7.5	mV
Input offset current	I_{IO}	$R_S \leq 50\text{k}\Omega$	—	6.0	50	nA
Input bias current	I_{bias}	$R_S \leq 50\text{k}\Omega$	—	100	250	nA
Voltage gain	G_V	$R_L = 1\text{k}\Omega$	—	106	—	dB
Response time	t_r	Step input 100mV, Overdrive 5mV	—	200	—	ns
Saturation voltage	$V_{O(\text{sat})}$	$V_{IN} \geq 10\text{mV}$, $I_O = 50\text{mA}$	—	0.75	1.5	V
Strobe on current	I_{ST}		—	3	—	mA
Output leakage current	$I_{O(\text{leak})}$	$V_{IN} \geq 10\text{mV}$, $V_O = 35\text{V}$	—	0.2	50	nA
Positive supply current	I_{CC}		—	5.1	7.5	mA
Negative supply current	I_{EE}		—	4.1	5.0	mA
Input voltage range	V_I		—	± 14	—	V
Saturation voltage	$V_{O(\text{sat})}$	$V_{CC} \geq 4.5\text{V}$, $V_{EE} = 0\text{V}$, $V_{IN} \geq 10\text{mV}$, $I_O = 8\text{mA}$	—	0.23	0.4	V

Typical Application (Balance Strobe Pin, Output Pin, GND Pin)

Offset Null Circuit

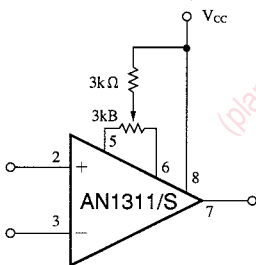

Strobe Circuit

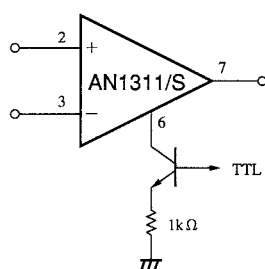

Increasing Input Stage Current

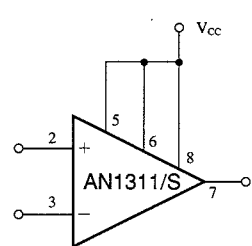

Collector Output

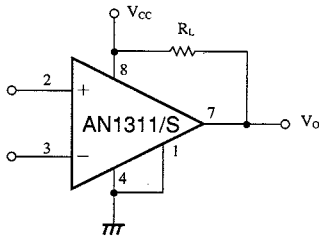

Emitter Output

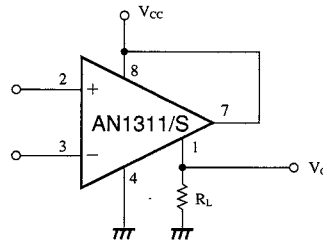

■ Characteristics Curve

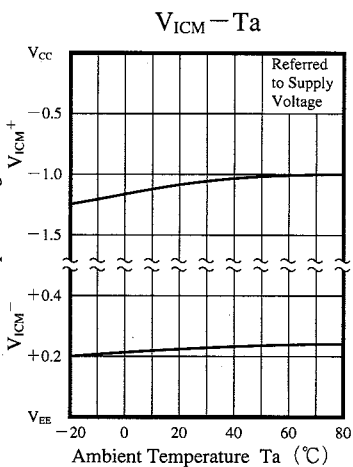
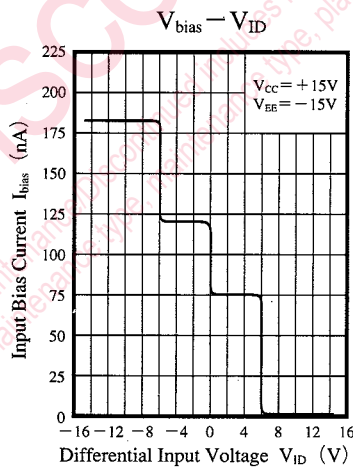
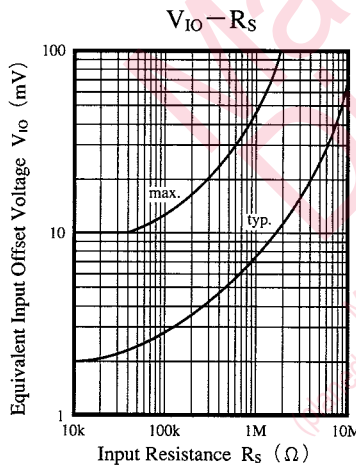
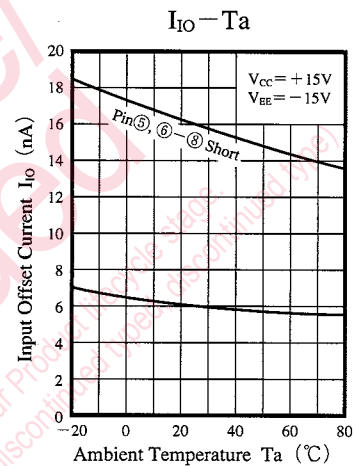
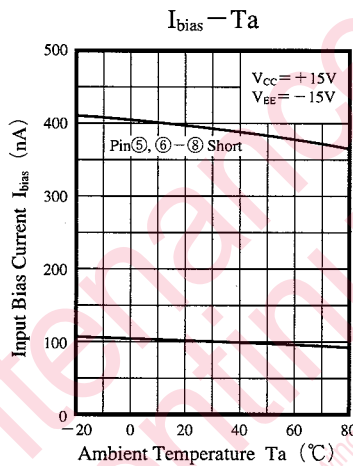
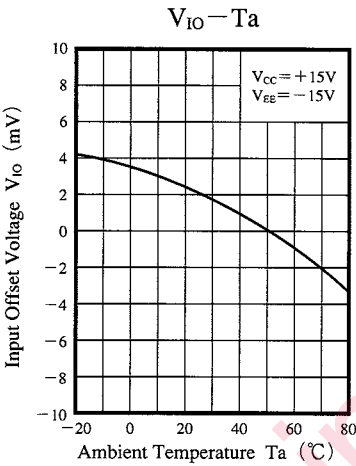

Comparators

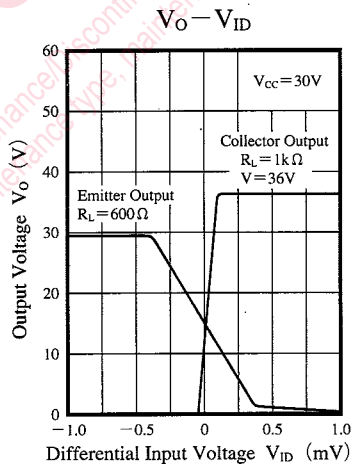
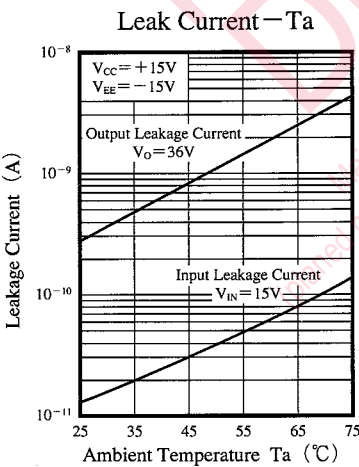
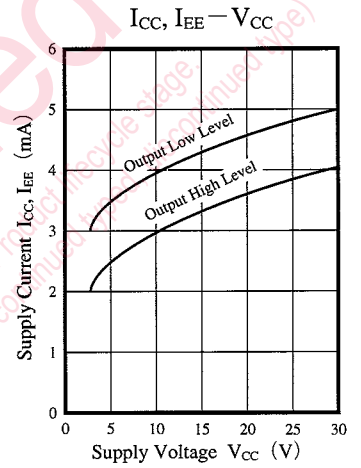
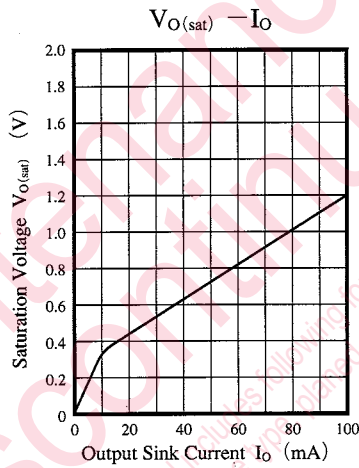
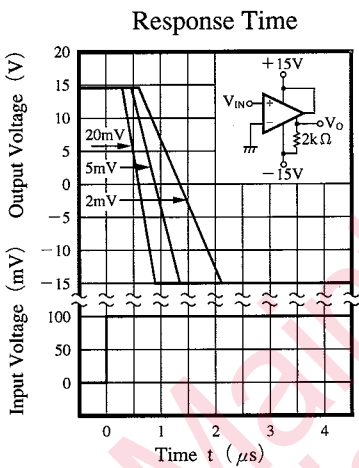
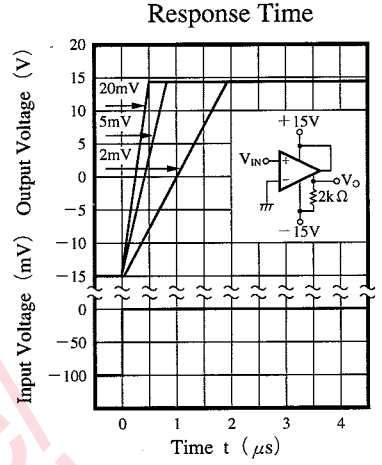
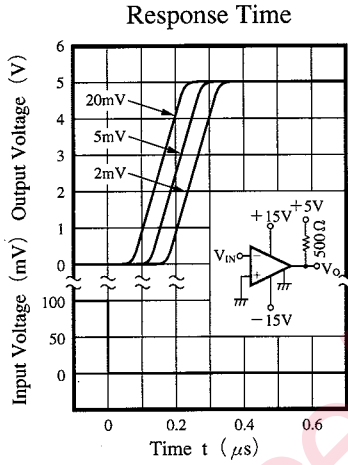
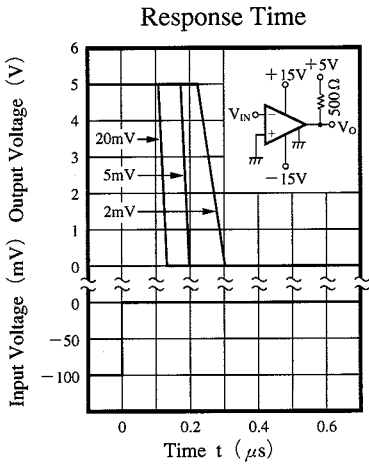

Request for your special attention and precautions in using the technical information and semiconductors described in this book

- (1) If any of the products or technical information described in this book is to be exported or provided to non-residents, the laws and regulations of the exporting country, especially, those with regard to security export control, must be observed.
- (2) The technical information described in this book is intended only to show the main characteristics and application circuit examples of the products. No license is granted in and to any intellectual property right or other right owned by Panasonic Corporation or any other company. Therefore, no responsibility is assumed by our company as to the infringement upon any such right owned by any other company which may arise as a result of the use of technical information described in this book.
- (3) The products described in this book are intended to be used for standard applications or general electronic equipment (such as office equipment, communications equipment, measuring instruments and household appliances).
Consult our sales staff in advance for information on the following applications:
 - Special applications (such as for airplanes, aerospace, automobiles, traffic control equipment, combustion equipment, life support systems and safety devices) in which exceptional quality and reliability are required, or if the failure or malfunction of the products may directly jeopardize life or harm the human body.
 - Any applications other than the standard applications intended.
- (4) The products and product specifications described in this book are subject to change without notice for modification and/or improvement. At the final stage of your design, purchasing, or use of the products, therefore, ask for the most up-to-date Product Standards in advance to make sure that the latest specifications satisfy your requirements.
- (5) When designing your equipment, comply with the range of absolute maximum rating and the guaranteed operating conditions (operating power supply voltage and operating environment etc.). Especially, please be careful not to exceed the range of absolute maximum rating on the transient state, such as power-on, power-off and mode-switching. Otherwise, we will not be liable for any defect which may arise later in your equipment.
 - Even when the products are used within the guaranteed values, take into the consideration of incidence of break down and failure mode, possible to occur to semiconductor products. Measures on the systems such as redundant design, arresting the spread of fire or preventing glitch are recommended in order to prevent physical injury, fire, social damages, for example, by using the products.
- (6) Comply with the instructions for use in order to prevent breakdown and characteristics change due to external factors (ESD, EOS, thermal stress and mechanical stress) at the time of handling, mounting or at customer's process. When using products for which damp-proof packing is required, satisfy the conditions, such as shelf life and the elapsed time since first opening the packages.
- (7) This book may be not reprinted or reproduced whether wholly or partially, without the prior written permission of our company.