

# MOS INTEGRATED CIRCUIT MC-4R64CKE6B

### Direct Rambus™ DRAM RIMM™ Module 64M-BYTE (32M-WORD x 16-BIT)

#### Description

The Direct Rambus RIMM module is a general purpose high-performance memory module subsystem suitable for use in a broad range of applications including computer memory, personal computers, workstations, and other applications where high bandwidth and low latency are required.

MC-4R64CKE6B module consists of four 128M Direct Rambus DRAM (Direct RDRAM™) devices ( $\mu$ PD488448). These are extremely high-speed CMOS DRAMs organized as 8M words by 16 bits. The use of Rambus Signaling Level (RSL) technology permits 600MHz, 711MHz or 800MHz transfer rates while using conventional system and board design technologies.

Direct RDRAM devices are capable of sustained data transfers at 1.25 ns per two bytes (10 ns per sixteen bytes).

The architecture of the Direct RDRAM enables the highest sustained bandwidth for multiple, simultaneous, randomly addressed memory transactions. The separate control and data buses with independent row and column control yield over 95 % bus efficiency. The Direct RDRAM's 32 banks support up to four simultaneous transactions per device.

#### Features

- 184 edge connector pads with 1mm pad spacing
- 64 MB Direct RDRAM storage
- Each RDRAM® has 32 banks, for 128 banks total on module
- Gold plated contacts
- RDRAMs use Chip Scale Package (CSP)
- Serial Presence Detect support
- Operates from a 2.5 V supply
- Low power and powerdown self refresh modes
- Separate Row and Column buses for higher efficiency

#### Order information

Part number	Organization	I/O Freq. MHz	t <sub>RAC</sub> ns	Package	Mounted devices
MC-4R64CKE6B - 845	32M x 16	800	45	184 edge connector pads RIMM with heat spreader	4 pieces of $\mu$ PD488448FB FBGA (D <sup>2</sup> BGA) package
MC-4R64CKE6B - 745		711	45		
MC-4R64CKE6B - 653		600	53	Edge connector : Gold plated	

The information in this document is subject to change without notice. Before using this document, please confirm that this is the latest version.  
Not all devices/types available in every country. Please check with local NEC representative for availability and additional information.

Module Pad Configuration

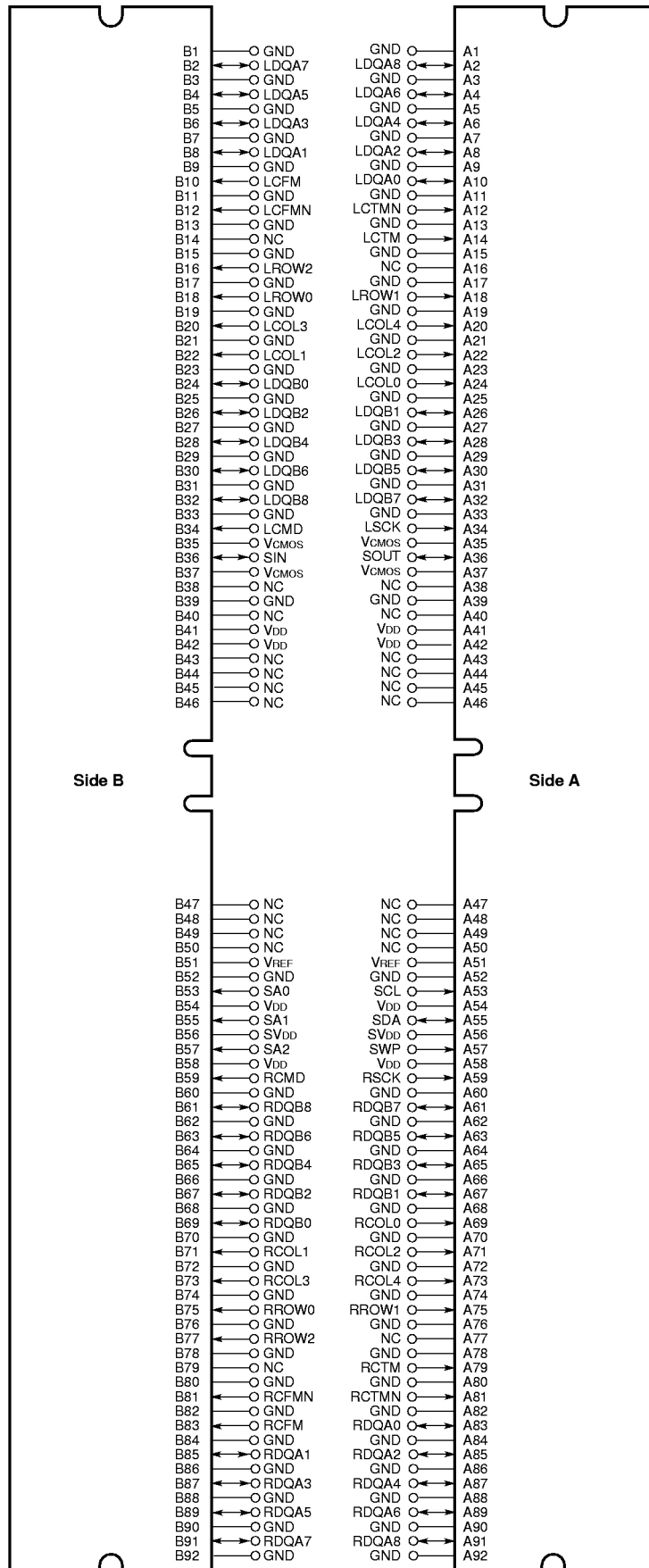

- LCFM, LCFMN, RCFM, RCFMN : Clock from master
- LCTM, LCTMN, RCTM, RCTMN : Clock to master
- LCMD, RCMD : Serial Command Pad
- LROW2 - LROW0, RROW2 - RROW0 : Row bus
- LCOL4 - LCOL0, RCOL4 - RCOL0 : Column bus
- LDQA8 - LDQA0, RDQA8 - RDQA0 : Data bus A
- LDQB8 - LDQB0, RDQB8 - RDQB0 : Data bus B
- LSCK, RSCK : Clock input
- SA0 - SA2 : Serial Presence Detect Address
- SCL, SDA : Serial Presence Detect Clock
- SIN, SOUT : Serial I/O
- SVDD : SPD Voltage
- SWP : Serial Presence Detect Write Protect
- VCMOS : Supply voltage for serial pads
- VDD : Supply voltage
- VREF : Logic threshold
- GND : Ground reference
- NC : These pads are not connected

Module Pad Names

Pad	Signal Name	Pad	Signal Name
A1	GND	B1	GND
A2	LDQA8	B2	LDQA7
A3	GND	B3	GND
A4	LDQA6	B4	LDQA5
A5	GND	B5	GND
A6	LDQA4	B6	LDQA3
A7	GND	B7	GND
A8	LDQA2	B8	LDQA1
A9	GND	B9	GND
A10	LDQA0	B10	LCFM
A11	GND	B11	GND
A12	LCTMN	B12	LCFMN
A13	GND	B13	GND
A14	LCTM	B14	NC
A15	GND	B15	GND
A16	NC	B16	LROW2
A17	GND	B17	GND
A18	LROW1	B18	LROW0
A19	GND	B19	GND
A20	LCOL4	B20	LCOL3
A21	GND	B21	GND
A22	LCOL2	B22	LCOL1
A23	GND	B23	GND
A24	LCOL0	B24	LDQB0
A25	GND	B25	GND
A26	LDQB1	B26	LDQB2
A27	GND	B27	GND
A28	LDQB3	B28	LDQB4
A29	GND	B29	GND
A30	LDQB5	B30	LDQB6
A31	GND	B31	GND
A32	LDQB7	B32	LDQB8
A33	GND	B33	GND
A34	LSCK	B34	LCMD
A35	V <sub>CMOS</sub>	B35	V <sub>CMOS</sub>
A36	SOUT	B36	SIN
A37	V <sub>CMOS</sub>	B37	V <sub>CMOS</sub>
A38	NC	B38	NC
A39	GND	B39	GND
A40	NC	B40	NC
A41	V <sub>DD</sub>	B41	V <sub>DD</sub>
A42	V <sub>DD</sub>	B42	V <sub>DD</sub>
A43	NC	B43	NC
A44	NC	B44	NC
A45	NC	B45	NC
A46	NC	B46	NC

Pad	Signal Name	Pad	Signal Name
A47	NC	B47	NC
A48	NC	B48	NC
A49	NC	B49	NC
A50	NC	B50	NC
A51	V <sub>REF</sub>	B51	V <sub>REF</sub>
A52	GND	B52	GND
A53	SCL	B53	SA0
A54	V <sub>DD</sub>	B54	V <sub>DD</sub>
A55	SDA	B55	SA1
A56	SV <sub>DD</sub>	B56	SV <sub>DD</sub>
A57	SWP	B57	SA2
A58	V <sub>DD</sub>	B58	V <sub>DD</sub>
A59	RSCK	B59	RCMD
A60	GND	B60	GND
A61	RDQB7	B61	RDQB8
A62	GND	B62	GND
A63	RDQB5	B63	RDQB6
A64	GND	B64	GND
A65	RDQB3	B65	RDQB4
A66	GND	B66	GND
A67	RDQB1	B67	RDQB2
A68	GND	B68	GND
A69	RCOL0	B69	RDQB0
A70	GND	B70	GND
A71	RCOL2	B71	RCOL1
A72	GND	B72	GND
A73	RCOL4	B73	RCOL3
A74	GND	B74	GND
A75	RROW1	B75	RROW0
A76	GND	B76	GND
A77	NC	B77	RROW2
A78	GND	B78	GND
A79	RCTM	B79	NC
A80	GND	B80	GND
A81	RCTMN	B81	RCFMN
A82	GND	B82	GND
A83	RDQA0	B83	RCFM
A84	GND	B84	GND
A85	RDQA2	B85	RDQA1
A86	GND	B86	GND
A87	RDQA4	B87	RDQA3
A88	GND	B88	GND
A89	RDQA6	B89	RDQA5
A90	GND	B90	GND
A91	RDQA8	B91	RDQA7
A92	GND	B92	GND

★ **Module Connector Pad Description**

(1/2)

Signal	I/O	Type	Description
GND	-	-	Ground reference for RDRAM core and interface. 72 PCB connector pads.
LCFM	I	RSL	Clock from master. Interface clock used for receiving RSL signals from the Channel. Positive polarity.
LCFMN	I	RSL	Clock from master. Interface clock used for receiving RSL signals from the Channel. Negative polarity.
LCMD	I	VCMOS	Serial Command used to read from and write to the control registers. Also used for power management.
LCOL4..LCOL0	I	RSL	Column bus. 5-bit bus containing control and address information for column accesses.
LCTM	I	RSL	Clock to master. Interface clock used for transmitting RSL signals to the Channel. Positive polarity.
LCTMN	I	RSL	Clock to master. Interface clock used for transmitting RSL signals to the Channel. Negative polarity.
LDQA8..LDQA0	I/O	RSL	Data bus A. A 9-bit bus carrying a byte of read or write data between the Channel and the RDRAM. LDQA8 is non-functional on modules with x16 RDRAM devices.
LDQB8..LDQB0	I/O	RSL	Data bus B. A 9-bit bus carrying a byte of read or write data between the Channel and the RDRAM. LDQB8 is non-functional on modules with x16 RDRAM devices.
LROW2..LROW0	I	RSL	Row bus. 3-bit bus containing control and address information for row accesses.
LSCK	I	VCMOS	Serial clock input. Clock source used to read from and write to the RDRAM control registers.
NC	-	-	These pads are not connected. These 24 connector pads are reserved for future use.
RCFM	I	RSL	Clock from master. Interface clock used for receiving RSL signals from the Channel. Positive polarity.
RCFMN	I	RSL	Clock from master. Interface clock used for receiving RSL signals from the Channel. Negative polarity.
RCMD	I	VCMOS	Serial Command Input used to read from and write to the control registers. Also used for power management.
RCOL4..RCOL0	I	RSL	Column bus. 5-bit bus containing control and address information for column accesses.
RCTM	I	RSL	Clock to master. Interface clock used for transmitting RSL signals to the Channel. Positive polarity.
RCTMN	I	RSL	Clock to master. Interface clock used for transmitting RSL signals to the Channel. Negative polarity.
RDQA8..RDQA0	I/O	RSL	Data bus A. A 9-bit bus carrying a byte of read or write data between the Channel and the RDRAM. RDQA8 is non-functional on modules with x16 RDRAM devices.
RDQB8..RDQB0	I/O	RSL	Data bus B. A 9-bit bus carrying a byte of read or write data between the Channel and the RDRAM. RDQB8 is non-functional on modules with x16 RDRAM devices.
RROW2..RROW0	I	RSL	Row bus. 3-bit bus containing control and address information for row accesses.

(2/2)

Signal	I/O	Type	Description
RSCK	I	V <sub>CMOS</sub>	Serial clock input. Clock source used to read from and write to the RDRAM control registers.
SA0	I	SV <sub>DD</sub>	Serial Presence Detect Address 0.
SA1	I	SV <sub>DD</sub>	Serial Presence Detect Address 1.
SA2	I	SV <sub>DD</sub>	Serial Presence Detect Address 2.
SCL	I	SV <sub>DD</sub>	Serial Presence Detect Clock.
SDA	I/O	SV <sub>DD</sub>	Serial Presence Detect Data (Open Collector I/O).
SIN	I/O	V <sub>CMOS</sub>	Serial I/O for reading from and writing to the control registers. Attaches to SIO0 of the first RDRAM on the module.
SOUT	I/O	V <sub>CMOS</sub>	Serial I/O for reading from and writing to the control registers. Attaches to SIO1 of the last RDRAM on the module.
SV <sub>DD</sub>	-	-	SPD Voltage. Used for signals SCL, SDA, SWP, SA0, SA1 and SA2.
SWP	I	SV <sub>DD</sub>	Serial Presence Detect Write Protect (active high). When low, the SPD can be written as well as read.
V <sub>CMOS</sub>	-	-	CMOS I/O Voltage. Used for signals CMD, SCK, SIN, SOUT.
V <sub>DD</sub>	-	-	Supply voltage for the RDRAM core and interface logic.
V <sub>REF</sub>	-	-	Logic threshold reference voltage for RSL signals.

Block Diagram

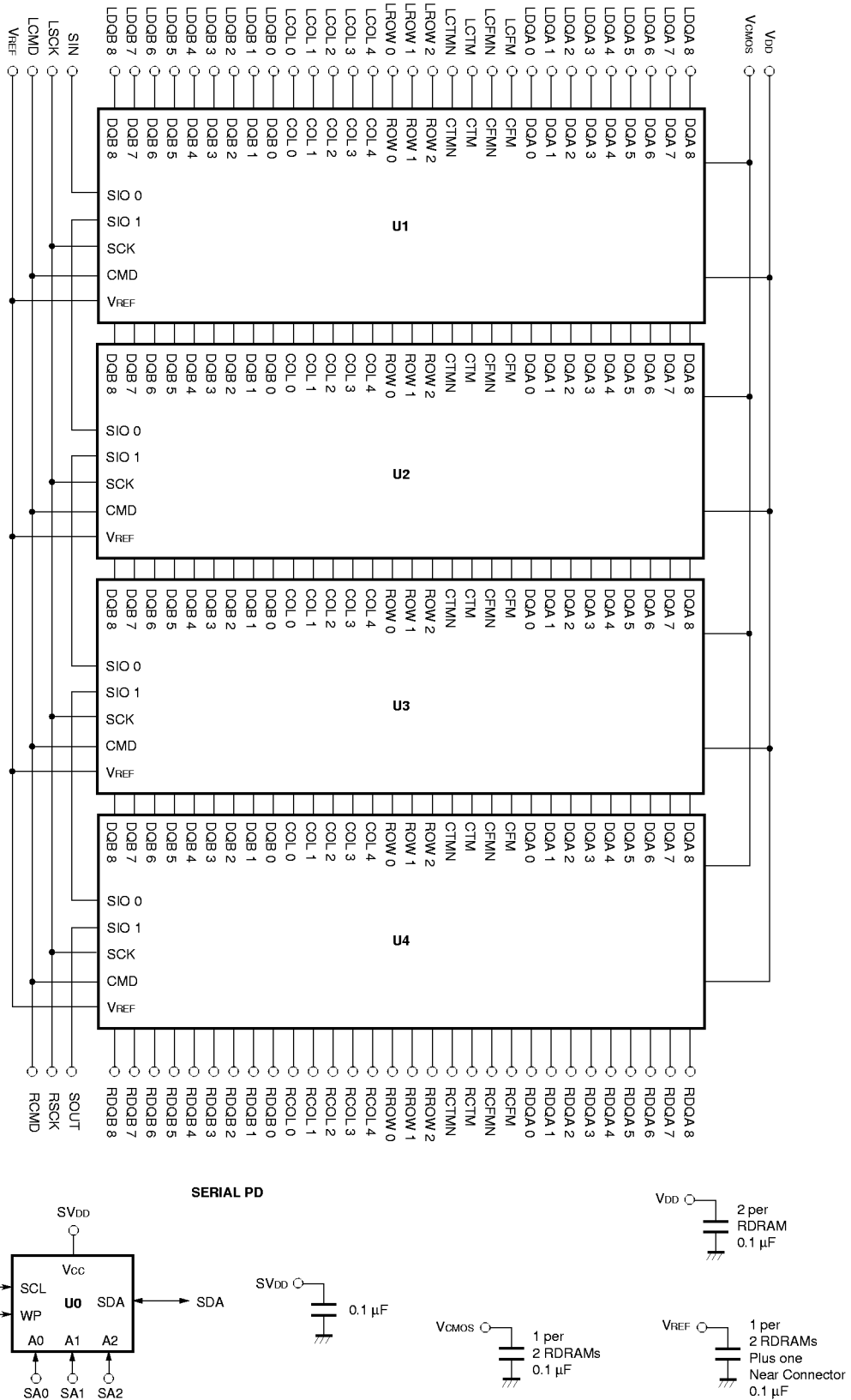

**Remarks** 1. Rambus Channel signals form a loop through the RIMM module, with the exception of the SIO chain.  
 2. See Serial Presence Detection Specification for information on the SPD device and its contents.

**Electrical Specification**

**Absolute Maximum Ratings**

Symbol	Parameter	MIN.	MAX.	Unit
★ $V_{I,ABS}$	Voltage applied to any RSL or CMOS signal pad with respect to GND	-0.3	$V_{DD} + 0.3$	V
$V_{DD,ABS}$	Voltage on $V_{DD}$ with respect to GND	-0.5	$V_{DD} + 1.0$	V
$T_{STORE}$	Storage temperature	-50	+100	°C

**Caution** Exposing the device to stress above those listed in Absolute Maximum Ratings could cause permanent damage. The device is not meant to be operated under conditions outside the limits described in the operational section of this specification. Exposure to Absolute Maximum Rating conditions for extended periods may affect device reliability.

**DC Recommended Electrical Conditions**

Symbol	Parameter and conditions	MIN.	MAX.	Unit
$V_{DD}$	Supply voltage	$2.50 - 0.13$	$2.50 + 0.13$	V
★ $V_{CMOS}$	CMOS I/O power supply at pad	2.5V controllers	$2.5 - 0.13$	$2.5 + 0.25$
		1.8V controllers	$1.8 - 0.1$	$1.8 + 0.2$
$V_{REF}$	Reference voltage	$1.4 - 0.2$	$1.4 + 0.2$	V
$V_{IL}$	RSL input low voltage	$V_{REF} - 0.5$	$V_{REF} - 0.2$	V
$V_{IH}$	RSL input high voltage	$V_{REF} + 0.2$	$V_{REF} + 0.5$	V
$V_{IL,CMOS}$	CMOS input low voltage	-0.3	$0.5V_{CMOS} - 0.25$	V
★ $V_{IH,CMOS}$	CMOS input high voltage	$0.5V_{CMOS} + 0.25$	$V_{CMOS} + 0.3$	V
$V_{OL,CMOS}$	CMOS output low voltage, $I_{OL,CMOS} = 1\text{ mA}$	—	0.3	V
$V_{OH,CMOS}$	CMOS output high voltage, $I_{OH,CMOS} = -0.25\text{ mA}$	$V_{CMOS} - 0.3$	—	V
$I_{REF}$	$V_{REF}$ current, $V_{REF,MAX}$	-40.0	+40.0	$\mu\text{A}$
$I_{SCK,CMD}$	CMOS input leakage current, ( $0 \leq V_{CMOS} \leq V_{DD}$ )	-40.0	+40.0	$\mu\text{A}$
$I_{SIN,SOUT}$	CMOS input leakage current, ( $0 \leq V_{CMOS} \leq V_{DD}$ )	-10.0	+10.0	$\mu\text{A}$

★ AC Electrical Specifications

Symbol	Parameter and Conditions	MIN.	TYP.	MAX.	Unit
Z	Module Impedance	25.2	28	30.8	Ω
T <sub>PD</sub>	Average clock delay from finger to finger of all RSL clock nets (CTM, CTMN, CFM, and CFMN)	-845		1.25	ns
		-745		1.25	
		-653		1.25	
ΔT <sub>PD</sub>	Propagation delay variation of RSL signals with respect to T <sub>PD</sub> <sup>Note1,2</sup>	-21		+21	ps
ΔT <sub>PD-CMOS</sub>	Propagation delay variation of SCK and CMD signals with respect to an average clock delay <sup>Note1</sup>	-100		+100	ps
V <sub>α</sub> /V <sub>IN</sub>	Attenuation Limit	-845		12	%
		-745		12	
		-653		8	
V <sub>XF</sub> /V <sub>IN</sub>	Forward crosstalk coefficient (300ps input rise time 20% - 80%)	-845		2	%
		-745		2	
		-653		2	
V <sub>XB</sub> /V <sub>IN</sub>	Backward crosstalk coefficient (300ps input rise time 20% - 80%)	-845		1.5	%
		-745		1.5	
		-653		1.5	
R <sub>DC</sub>	DC Resistance Limit	-845		0.6	Ω
		-745		0.6	
		-653		0.6	

**Notes 1.** T<sub>PD</sub> or Average clock delay is defined as the average delay from finger to finger of all RSL clock nets (CTM, CTMN, CFM, and CFMN).

- 2.** If the RIMM module meets the following specification, then it is compliant to the specification. If the RIMM module does not meet these specifications, then the specification can be adjusted by the "Adjusted ΔT<sub>PD</sub> Specification" table.

★ Adjusted ΔT<sub>PD</sub> Specification

Symbol	Parameter and conditions	Adjusted MIN./MAX.	Absolute		Unit
			MIN.	MAX.	
ΔT <sub>PD</sub>	Propagation delay variation of RSL signals with respect to T <sub>PD</sub>	+/- [17+(18*N*ΔZ0)] <sup>Note</sup>	-30	+30	ps

**Note** N = Number of RDRAM devices installed on the RIMM module.

$$\Delta Z0 = \text{delta } Z0\% = (\text{MAX. } Z0 - \text{MIN. } Z0) / (\text{MIN. } Z0)$$

(MAX. Z0 and MIN. Z0 are obtained from the loaded (high impedance) impedance coupons of all RSL layers on the module.

★ **RIMM Module Current Profile**

I <sub>DD</sub>	RIMM module power conditions	MAX.	Unit
I <sub>DD1</sub>	One RDRAM in Read , balance in NAP mode	TBD	mA
I <sub>DD2</sub>	One RDRAM in Read , balance in Standby mode	TBD	mA
I <sub>DD3</sub>	One RDRAM in Read , balance in Active mode	TBD	mA
I <sub>DD4</sub>	One RDRAM in Write, balance in NAP mode	TBD	mA
I <sub>DD5</sub>	One RDRAM in Write, balance in Standby mode	TBD	mA
I <sub>DD6</sub>	One RDRAM in Write, balance in Active mode	TBD	mA

**Timing Parameters**

The following timing parameters are from the RDRAMs pins, not the RIMM. Please refer to the RDRAM data sheet ( $\mu$ PD488448, 488488) for detailed timing diagrams.

Parameter	Description	MIN.			MAX.	Units
		-845	-745	-653		
t <sub>RC</sub>	Row Cycle time of RDRAM banks - the interval between ROWA packets with ACT commands to the same bank.	28	28	28	—	t <sub>CYCLE</sub>
t <sub>RAS</sub>	RAS-asserted time of RDRAM bank - the interval between ROWA packet with ACT command and next ROWR packet with PRER <sup>Note 1</sup> command to the same bank.	20	20	20	Note 2 64 $\mu$ s	t <sub>CYCLE</sub>
t <sub>RP</sub>	Row Precharge time of RDRAM banks - the interval between ROWR packet with PRER <sup>Note 1</sup> command and next ROWA packet with ACT command to the same bank.	8	8	8	—	t <sub>CYCLE</sub>
t <sub>PP</sub>	Precharge-to-precharge time of RDRAM device - the interval between successive ROWR packets with PRER <sup>Note 1</sup> commands to any banks of the same device.	8	8	8	—	t <sub>CYCLE</sub>
t <sub>RR</sub>	RAS-to-RAS time of RDRAM device - the interval between successive ROWA packets with ACT commands to any banks of the same device.	8	8	8	—	t <sub>CYCLE</sub>
t <sub>RCD</sub>	RAS-to-CAS Delay - the interval from ROWA packet with ACT command to COLC packet with RD or WR command. Note - the RAS-to-CAS delay seen by the RDRAM core (t <sub>RCD-C</sub> ) is equal to t <sub>RCD-C</sub> = 1 + t <sub>RCD</sub> because of differences in the row and column paths through the RDRAM interface.	9	7	7	—	t <sub>CYCLE</sub>
t <sub>CAC</sub>	CAS Access delay - the interval from RD command to Q read data. The equation for t <sub>CAC</sub> is given in the TPARAM register.	8	8	8	12	t <sub>CYCLE</sub>
t <sub>CWD</sub>	CAS Write Delay - interval from WR command to D write data.	6	6	6	6	t <sub>CYCLE</sub>
t <sub>CC</sub>	CAS-to-CAS time of RDRAM bank – the interval between successive COLC commands.	4	4	4	—	t <sub>CYCLE</sub>
t <sub>PACKET</sub>	Length of ROWA, ROWR, COLC, COLM or COLX packet.	4	4	4	4	t <sub>CYCLE</sub>
t <sub>RTR</sub>	Interval from COLC packet with WR command to COLC packet which causes retire, and to COLM packet with bytemask.	8	8	8	—	t <sub>CYCLE</sub>
t <sub>OFFP</sub>	The interval (offset) from COLC packet with RDA command, or from COLC packet with retire command (after WRA automatic precharge), or from COLC packet with PREC command, or from COLX packet with PREX command to the equivalent ROWR packet with PRER. The equation for t <sub>OFFP</sub> is given in the TPARAM register.	4	4	4	4	t <sub>CYCLE</sub>
t <sub>RDP</sub>	Interval from last COLC packet with RD command to ROWR packet with PRER.	4	4	4	—	t <sub>CYCLE</sub>
t <sub>RTP</sub>	Interval from last COLC packet with automatic retire command to ROWR packet with PRER.	4	4	4	—	t <sub>CYCLE</sub>

**Notes 1.** Or equivalent PREC or PREX command.

**2.** This is a constraint imposed by the core, and is therefore in units of ms rather than t<sub>CYCLE</sub>.

Package Drawings

★ 184 EDGE CONNECTOR PADS RIMM (SOCKET TYPE) (1/2)

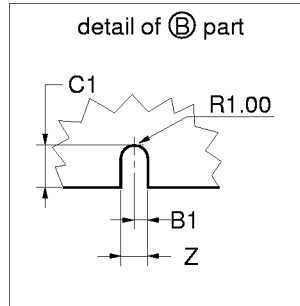
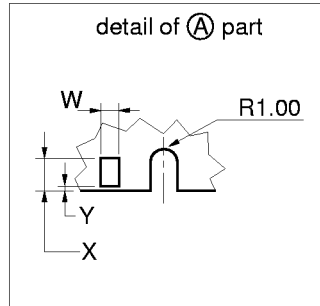
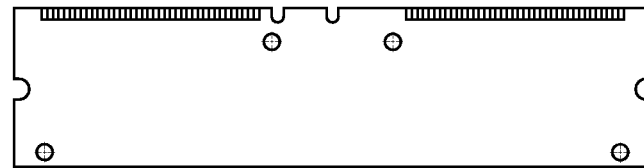
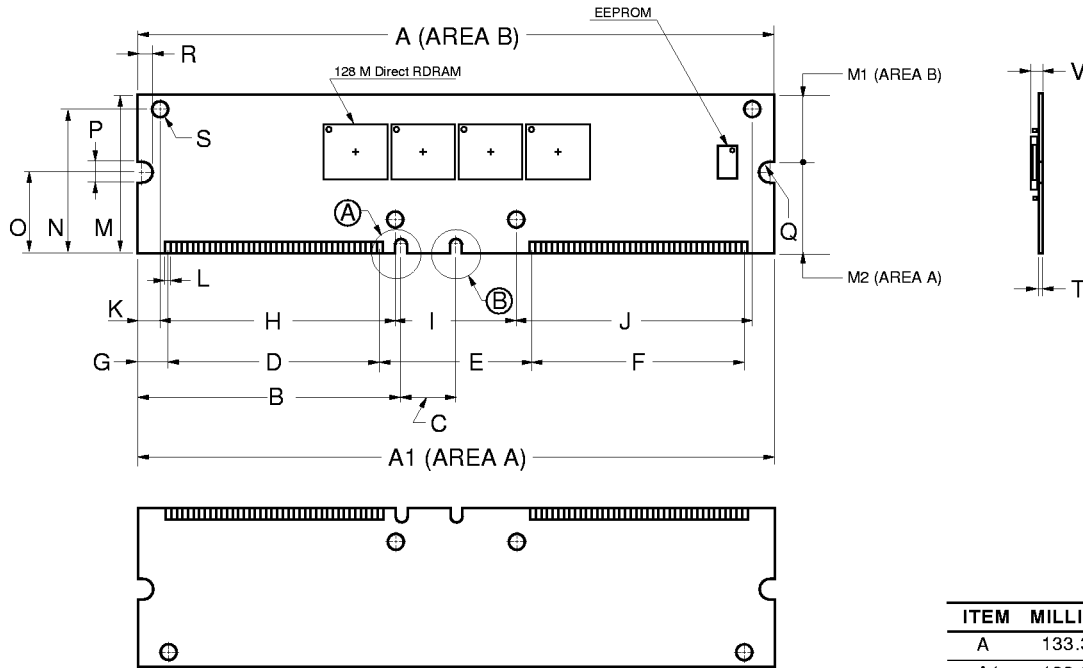

ITEM	MILLIMETERS
A	133.35 TYP.
A1	133.35±0.13
B	55.175
B1	1.00±0.10
C	11.50
C1	3.00±0.10
D	45.00
E	32.00
F	45.00
G	5.675
H	47.625
I	25.40
J	47.625
K	6.35
L	1.00 TYP.
M	31.75±0.13
M1	11.97
M2	19.78
N	29.21
O	17.78
P	4.00±0.10
Q	R 2.00
R	3.00±0.10
S	∅2.44
T	1.27±0.10
V	2.24 MAX.
W	0.80±0.10
X	2.99
Y	0.15
Z	2.00±0.10

★ 184 EDGE CONNECTOR PADS RIMM (SOCKET TYPE) (2/2)

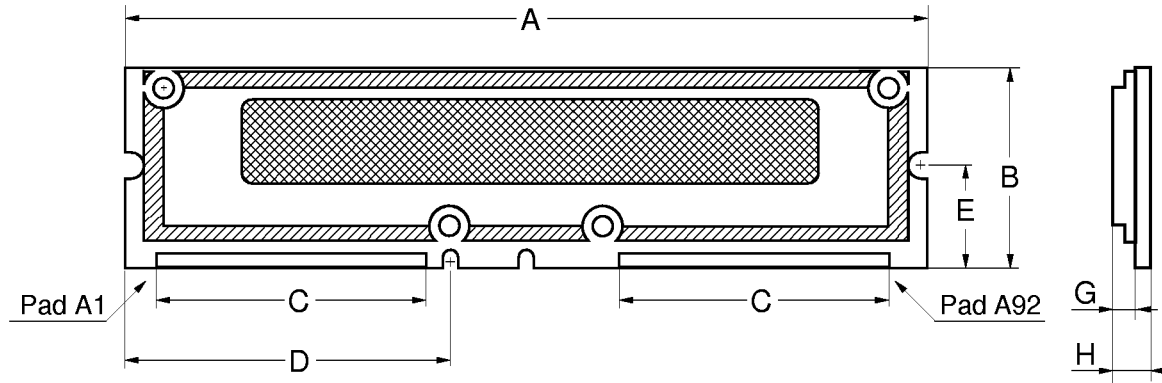

ITEM	DESCRIPTION	MIN.	TYP.	MAX.	UNIT
A	PCB length	133.22	133.35	133.48	mm
B	PCB height for 1.25" RIMM Module	31.62	31.75	31.88	mm
C	Center-center pad width from pad A1 to A46, A47 to A92, B1 to B46 or B47 to B92	44.95	45.00	45.05	mm
D	Spacing from PCB left edge to connector key notch	-	55.175	-	mm
E	Spacing from contact pad PCB edge to side edge retainer notch	-	17.78	-	mm
F	PCB thickness	1.17	1.27	1.37	mm
G	Heat spreader thickness from PCB surface (one side) to heat spreader top surface	-	-	3.09	mm
H	RIMM thickness	-	-	4.46	mm