

IEC Appliance Inlet C20 with Filter, Circuit Breaker TA45 (recessed)

Standard- or Medical-Filter



C20

 70° C



Description

- Panel Mount:
Screw-on mounting from front side
- 3 Functions:
Appliance Inlet Protection class I, circuit breaker type TA45 2-pole, Line filter in standard and medical version
- Quick connect terminals 6.3 x 0.8 mm

Approvals

- VDE Certificate Number: 40001520
- UL File Number: E72928

Characteristics

- All single elements are already wired
- Line switch non-illuminated
Illuminated version on request
- Thermal overload protection
- Optional with undervoltage- or remote trip release
- With EMC-shield
- Qualified for use in equipment according IEC/EN 60950

Other versions on request

- Variant with notch for V-Lock mating Cordsets

References

Alternative: version without line filter [EF11](#)

Weblinks

[pdf](#), [html](#), [General Product Information](#), [Approvals](#), [RoHS](#), [CHINA-RoHS](#), [Mating Connectors](#), [e-Shop](#), [SCHURTER-Stock-Check](#), [Distributor-Stock-Check](#), [Accessories](#)

Newly available variants corresponding to V-Lock mating cordset. The connector is equipped with a notch intended for use with the latching cordset. The cord latching system prevents against accidental removal of the cordset.

Technical Data

Ratings IEC	12 - 16A @ Ta 40 °C / 250 VAC; 50Hz	Appliance-Inlet/-Outlet	C20 acc. to IEC/EN 60320-1, UL 498, CSA C22.2 no. 42 (for cold conditions) pin-temperature 70 °C, 16A, Protection Class 1
Ratings UL/CSA	12 - 20A @ Ta 40 °C / 125 VAC; 60Hz	Circuit Breakers	Acc. IEC/EN 60934, UL 1077, CSA 22.2 no. 235 2-pole rocker switch, illuminated or non-illuminated. Optional with undervoltage- or remote trip release Short circuit capacity Icn: at In < 3A/240VAC : 10 x In at In ≥ 3A/240VAC : 300A
Leakage Current	standard < 0.5 mA (250 V / 60Hz) medical < 5 µA (250 V / 60 Hz)	Line Switch	Rocker switch 2-pole, non-illuminated or illuminated, acc. to IEC 61058-1 Technical Details
Dielectric Strength	> 1.7 kVDC between L-N > 2.7 kVDC between L/N-PE Test voltage (2 sec)	Line Filter	Standard and Medical Version, IEC 60939, IEC 60601-1, UL 1283, UL 544, EN 133 200, CSA C22.2 no. 8 Technical Details
Allowable Operation Temp.	-10 °C to 55 °C	MTBF	> 100'000h acc. to MIL-HB-217 F
Climatic Category	10/055/21 acc. to IEC 60068-1		
Degree of Protection	from front side IP 40 acc. to IEC 60529		
Protection Class	Suitable for appliances with protection class 1 acc. to IEC 61140		
Terminal	Quick connect terminals 6.3 x 0.8 mm		
Panel Thickness s	Screw: max 8 mm Mounting screw torque max 0.5 Nm		
Material: Housing	Thermoplastic, black, UL 94V-0		

Dimensions

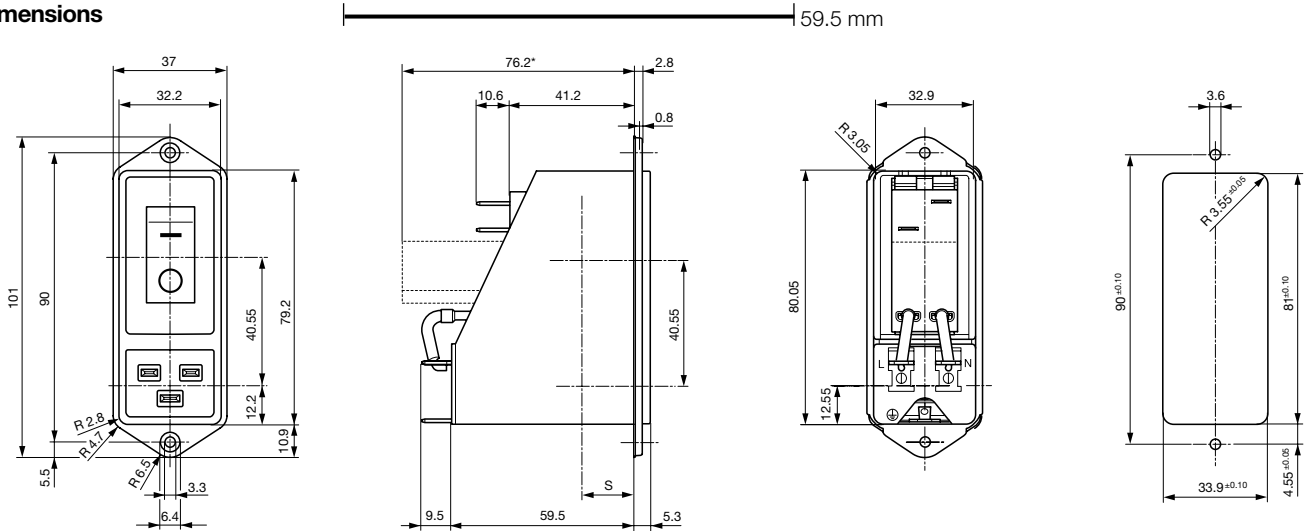

* --- Version TA45 with undervoltage release

Technical Data of Filter-Components

Rated Current [A]	Filter-Type	Inductances L [mH]	Capacitance CX [nF]	Capacitance CY [nF]	R [MΩ]
12	Standard Version	2 x 0.8	100	2.2	1
16	Standard Version	2 x 0.6	100	2.2	1
20	Standard Version	2 x 0.3	100	2.2	1
12	Medical Version (M5)	2 x 0.8	100	-	1
16	Medical Version (M5)	2 x 0.6	100	-	1
20	Medical Version (M5)	2 x 0.3	100	-	1

Diagrams

Standard version

Medical version

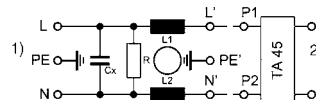
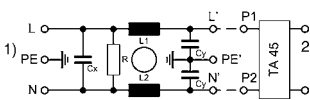

1) Line
2) Load

1) Line
2) Load

Attenuation Loss

--- differential mode ____ common mode

Standard version

12 A

16 A

20 A

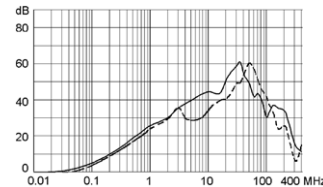
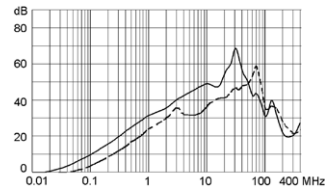
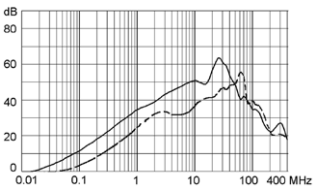

Medical version (M5)

12 A

16 A

20 A

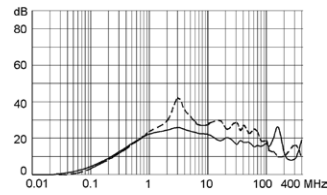
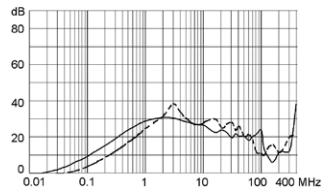
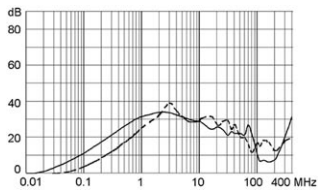

Table 1 Selection for type TA45

Order example



- Line switch
- 2-pole, rocker actuated
- Quick connect terminal
- Other types on request

ABT W F 150 C0

Diagram

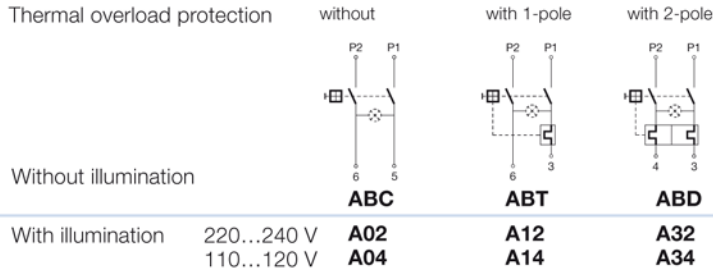

Colours

Switch front	Rocker	
W black	white	—
B black	black	—
6 black	—	orange transp.

Rocker legend

Surface	Illustration	Colour of print	Surface	Illustration	Colour of print
F embossed	— ○		M printed	— ○	black
H printed	ON OFF	white	P printed	I ○	white
K printed	ON OFF	black	R printed	I ○	black
L printed	— ○	white			

Position of the rocker legend
e.g F

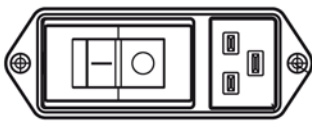

Rated current:

- Without thermal overload protection: code C00 } $I_n = 20\text{ A}$
- With thermal overload protection: rated current I_n (A)

I_n	Code	I_n	Code	I_n	Code	I_n	Code
10,0	100	13,0	130	16,0	160	19,0	190
11,0	110	14,0	140	17,0	170	20,0	200
12,0	120	15,0	150	18,0	180		

Other rated currents on request

Without release: code C0

Undervoltage release

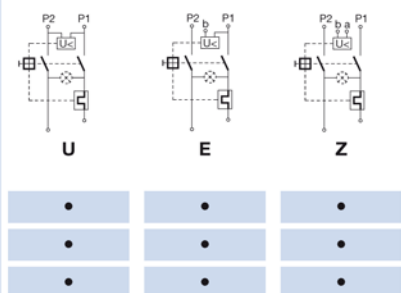

Remote trip release

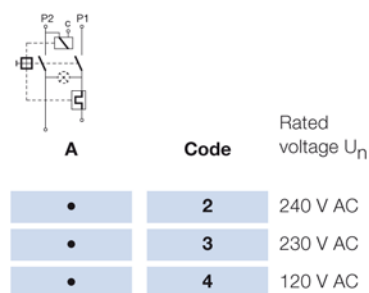

Technical data (continued)

Circuit breaker

Tripping characteristics

$I_n < 3 A$

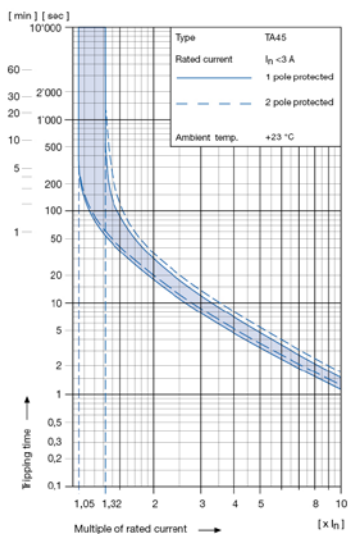

Tripping characteristics

$I_n \ge 3... < 18 A$

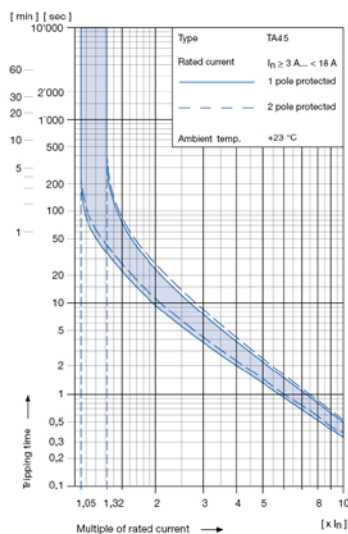

Tripping characteristics

$I_n \ge 18 A$

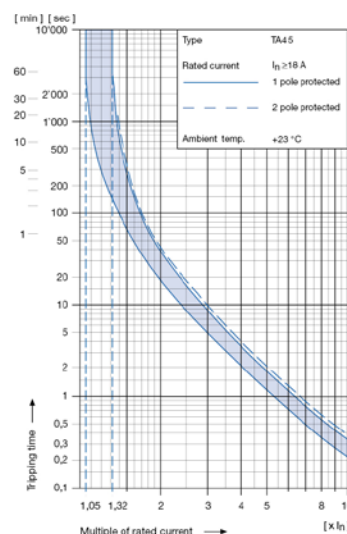

1) Effect of ambient temperature

The unit is calibrated for an ambient temperature of +23 °C. To determine the rated current for a lower or higher ambient temperature, use a correction factor from the table on the right side:

* Ambient temperature [°C]	Correction factor
-10	0,89
-5	0,91
0	0,92
+23	1,00
+30	1,03
+40	1,08
+55	1,16

* Temperature must be measured at the rear of the breaker next to the terminals after equipment operating temperature has been reached.

1) Example

Rated current at +23 °C 6,0 A
 Ambient temperature +40 °C
 Correction factor 1,08
 Chosen rated current at
 +40 °C ambient temperature **6 A x 1,08 = 6,5 A**

Order code for EF12 (order example)

Type	Order code TA45 (2-pole rocker-switch without accessories)
EF12.	A B T W F 1 5 0 C 0 . see table 1

- 11 10.01
- Wiring
1 = wired
- Protection class
0 = Class I, housing black
- Panel mount
0 = Screw-on version
- Terminals
1 = Quick connect terminals 6,3 x 0,8 mm
- Line filter version
1 = standard
2 = medical
- Line filter, rated current
1 = 20 A, 2 = 16 A, 3 = 12 A

Please note that Schurter will establish an internal new part number for logistical use in addition to the order code. The format of this internal part number is, for example EF12.xxxx.1110.01

Application note

The rated current of the line filter must be equal or higher than the rated current of the circuit-breaker

Other versions on request

- Rocker switch illuminated

Packaging unit 16 Pcs

Accessories

Description

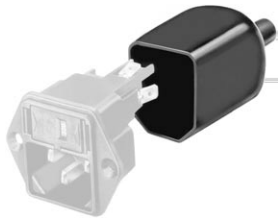

Assorted Covers
Rear Cover



Front Cover
Front Cover



Cord retaining kits
Cord retaining strain relief

Mating Outlets/Connectors

Category / Description

Connector Overview complete



IEC Connector C19, Rewireable, Straight	0104
IEC Connector C19, Rewireable, Straight	0104U
IEC Connector C19, Rewireable, Angled	1651
IEC Connector C19, Rewireable, Straight	1652
IEC Connector C19, Rewireable, Angled	4790
Connector further types toEF12	...

Power Cord Overview complete



Power Cord with IEC Connector C19, Straight	1654
Power Cord further types toEF12	

Power Supply or Interconnection Cord Overview complete



Diverse Power Supply and Interconnection Cords 16 A	Cord Sets 15 A
Power Supply or Interconnection Cord further types toEF12	