

Am25LS373 • Am54LS/74LS373 Am25LS533 • Am54LS/74LS533

Octal Latches with Three-State Outputs

DISTINCTIVE CHARACTERISTICS

- 8 latches in a single package
- Non-inverting 'LS373, inverting 'LS533
- Three-state outputs interface directly with bus organized systems
- Hysteresis on latch enable input for improved noise margin
- Am25LS devices offer the following improvements over Am54LS/74LS
 - Higher speed
 - Twice the fan-out over military range
- 100% product assurance screening to MIL-STD-883 requirements

FUNCTIONAL DESCRIPTION

The Am25LS/54LS/74LS373 and Am25LS/54LS/74LS533 are octal latches with three-state outputs for bus organized system applications. The latches appear to be transparent to the data (data changes asynchronously) when latch enable, G, is HIGH. When G is LOW, the data that meets the set-up times is latched. Data appears on the bus when the output enable, \overline{OE} , is LOW. When \overline{OE} is HIGH the bus output is in the high-impedance state.

The 'LS373 presents non-inverted data at the outputs while the 'LS533 is inverting.

LOGIC DIAGRAM Am25LS/54LS/74LS373

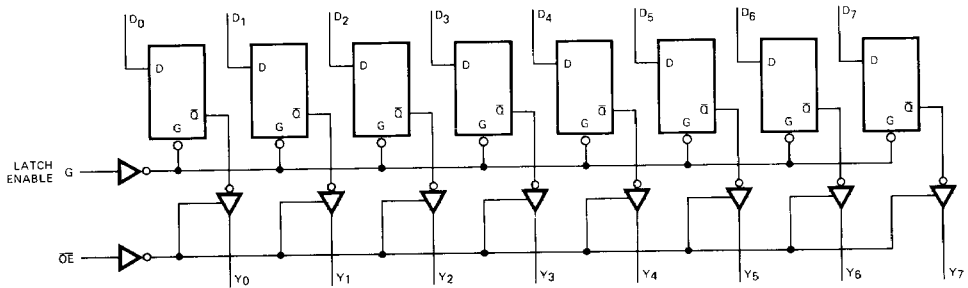

Inputs D_0 through D_7 are inverted on the Am25LS/54LS/74LS533.

BLI-04

CONNECTION DIAGRAMS Top Views

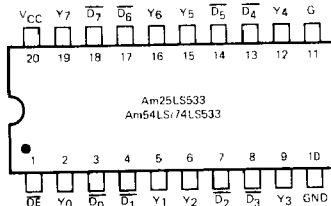
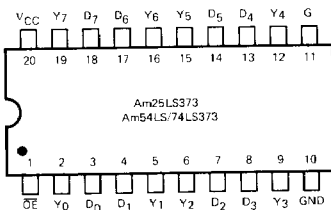

Note: Pin 1 is marked for orientation.

BLI-042

LOGIC SYMBOL

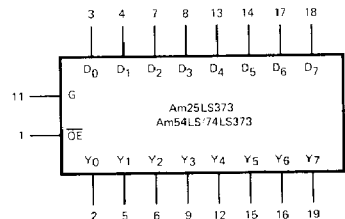

V_{CC} = Pin 20
 GND = Pin 10

Inputs D_0 through D_7 are inverted on the Am25LS/54LS/74LS533.

BLI-04

Am25LS373, Am25LS533

ELECTRICAL CHARACTERISTICS

The Following Conditions Apply Unless Otherwise Specified:

COM'L $T_A = 0^\circ\text{C to } +70^\circ\text{C}$ $V_{CC} = 5.0\text{V} \pm 5\%$ MIN. = 4.75 V MAX. = 5.25 V
 MIL $T_A = -55^\circ\text{C to } +125^\circ\text{C}$ $V_{CC} = 5.0\text{V} \pm 10\%$ MIN. = 4.50 V MAX. = 5.50 V

DC CHARACTERISTICS OVER OPERATING RANGE

Parameters	Description	Test Conditions (Note 1)		Min.	Typ. (Note 2)	Max.	Units
V_{OH}	Output HIGH Voltage	$V_{CC} = \text{MIN.}$ $V_{IN} = V_{IH} \text{ or } V_{IL}$	MIL	2.4	3.4		Volts
			COM'L	2.4	3.4		
V_{OL}	Output LOW Voltage	$V_{CC} = \text{MIN.}$ $V_{IN} = V_{IH} \text{ or } V_{IL}$	$I_{OL} = 12\text{mA}$			0.4	Volts
			$I_{OL} = 24\text{mA}$			0.5	
V_{IH}	Input HIGH Level	Guaranteed input logical HIGH voltage for all inputs		2.0			Volts
V_{IL}	Input LOW Level	Guaranteed input logical LOW voltage for all inputs		MIL		0.7	Volts
				COM'L		0.8	
V_I	Input Clamp Voltage	$V_{CC} = \text{MIN.}, I_{IN} = -18\text{mA}$				-1.5	Volts
I_{IL}	Input LOW Current	$V_{CC} = \text{MAX.}, V_{IN} = 0.4\text{V}$				-0.4	mA
I_{IH}	Input HIGH Current	$V_{CC} = \text{MAX.}, V_{IN} = 2.7\text{V}$				20	μA
I_I	Input HIGH Current	$V_{CC} = \text{MAX.}, V_{IN} = 7.0\text{V}$				0.1	mA
I_{OZ}	Off-State (High-Impedance) Output Current	$V_{CC} = \text{MAX.}$		$V_O = 0.4\text{V}$		-20	μA
				$V_O = 2.4\text{V}$		20	
I_{SC}	Output Short Circuit Current (Note 3)	$V_{CC} = \text{MAX.}$		-30		-85	mA
I_{CC}	Power Supply Current (Note 4)	$V_{CC} = \text{MAX.}$			24	40	mA

- Notes: 1. For conditions shown as MIN. or MAX., use the appropriate value specified under Electrical Characteristics for the applicable device type.
 2. Typical limits are at $V_{CC} = 5.0\text{V}$, 25°C ambient and maximum loading.
 3. Not more than one output should be shorted at a time. Duration of the short circuit test should not exceed one second.
 4. Inputs grounded; outputs open.

2

Am25LS • Am54LS/74LS**MAXIMUM RATINGS** (Above which the useful life may be impaired)

Storage Temperature	-65°C to +150°C
Temperature (Ambient) Under Bias	-55°C to +125°C
Supply Voltage to Ground Potential Continuous	-0.5V to +7.0V
DC Voltage Applied to Outputs for High Output State	-0.5V to + V_{CC} max.
DC Input Voltage	-0.5V to +7.0V
DC Output Current, Into Outputs	30mA
DC Input Current	-30mA to +5.0mA

ELECTRICAL CHARACTERISTICS

The Following Conditions Apply Unless Otherwise Specified:

COM'L	$T_A = 0^\circ\text{C to } +70^\circ\text{C}$	$V_{CC} = 5.0\text{V} \pm 5\%$	MIN. = 4.75 V	MAX. = 5.25 V
MIL	$T_A = -55^\circ\text{C to } +125^\circ\text{C}$	$V_{CC} = 5.0\text{V} \pm 10\%$	MIN. = 4.50 V	MAX. = 5.50 V

DC CHARACTERISTICS OVER OPERATING RANGE

Parameters	Description	Test Conditions (Note 1)		Min.	Typ.		Max.	Units
					(Note 2)			
V_{OH}	Output HIGH Voltage	$V_{CC} = \text{MIN.}$ $V_{IN} = V_{IH} \text{ or } V_{IL}$	$I_{OH} = -1.0\text{ mA}$	MIL	2.4	3.4		Volts
			$I_{OH} = -2.6\text{ mA}$	COM'L	2.4	3.4		
V_{OL}	Output LOW Voltage	$V_{CC} = \text{MIN.}$ $V_{IN} = V_{IH} \text{ or } V_{IL}$	All, $I_{OL} = 12\text{ mA}$			0.25	0.4	Volts
			74LS only, $I_{OL} = 24\text{ mA}$			0.35	0.5	
V_{IH}	Input HIGH Level	Guaranteed input logical HIGH voltage for all inputs			2.0			Volts
V_{IL}	Input LOW Level	Guaranteed input logical LOW voltage for all inputs		MIL			0.7	Volts
				COM'L			0.8	
V_I	Input Clamp Voltage	$V_{CC} = \text{MIN.}, I_{IN} = -18\text{ mA}$					-1.5	Volts
I_{IL}	Input LOW Current	$V_{CC} = \text{MAX.}, V_{IN} = 0.4\text{ V}$					-0.4	mA
I_{IH}	Input HIGH Current	$V_{CC} = \text{MAX.}, V_{IN} = 2.7\text{ V}$					20	μA
I_I	Input HIGH Current	$V_{CC} = \text{MAX.}, V_{IN} = 7.0\text{ V}$					0.1	mA
I_O	Off-State (High-Impedance) Output Current	$V_{CC} = \text{MAX.}$		$V_O = 0.4\text{ V}$			-20	μA
				$V_O = 2.4\text{ V}$			20	
I_{SC}	Output Short Circuit Current (Note 3)	$V_{CC} = \text{MAX.}$			-30		-130	mA
I_{CC}	Power Supply Current (Note 4)	$V_{CC} = \text{MAX.}$				24	40	mA

- Notes: 1. For conditions shown as MIN. or MAX., use the appropriate value specified under Electrical Characteristics for the applicable device type.
 2. Typical limits are at $V_{CC} = 5.0\text{ V}$, 25°C ambient and maximum loading.
 3. Not more than one output should be shorted at a time. Duration of the short circuit test should not exceed one second.
 4. Inputs grounded; outputs open.

FUNCTION TABLES

Am25LS/54LS/74LS373

Inputs			Internal	Outputs	Function
\overline{OE}	G	D_i	Q_i	Y_i	
H	X	X	X	Z	Hi-Z
L	H	L	H	L	Transparent
L	H	H	L	H	
L	L	X	NC	NC	Latched

Am25LS/54LS/74LS533

Inputs			Internal	Outputs	Function
\overline{OE}	G	D_i	Q_i	Y_i	
H	X	X	X	Z	Hi-Z
L	H	L	H	H	Transparent
L	H	H	L	L	
L	L	X	NC	NC	Latched

H = HIGH
L = LOW
X = Don't Care

NC = No Change
Z = High Impedance

DEFINITION OF FUNCTIONAL TERMS

Am25LS/54LS/74LS373

- D_i The latch data inputs.
 G The latch enable input. The latches are transparent when G is HIGH. Input data is latched on the HIGH-to-LOW transition.
 Y_i The three-state latch outputs.
 \overline{OE} The output enable control. When \overline{OE} is LOW, the outputs Y_i are enabled. When \overline{OE} is HIGH, the outputs Y_i are in the high-impedance (off) state.

Am25LS/54LS/74LS533

- \overline{D}_i The latch inverting data inputs.
 G The latch enable input. The latches are transparent when G is HIGH. Input data is latched on the HIGH-to-LOW transition.
 Y_i The three-state latch outputs.
 \overline{OE} The output enable control. When \overline{OE} is LOW, the inverted outputs Y_i are enabled. When \overline{OE} is HIGH, the outputs Y_i are in the high-impedance (off) state.

Am25LS/54LS/74LS373

SWITCHING CHARACTERISTICS

 $(T_A = +25^\circ\text{C}, V_{CC} = 5.0\text{V})$

Parameters	Description	Am25LS			Am54LS/74LS			Units	Test Conditions
		Min.	Typ.	Max.	Min.	Typ.	Max.		
t_{PLH}	Enable to Output		20	30		20	30	ns	$C_L = 45\text{pF}$ $R_L = 667\Omega$
t_{PHL}			18	30		18	30		
t_{PLH}	Data Input to Output		10	18		12	18		
t_{PHL}			12	18		12	18		
$t_s(H)$	HIGH Data to Enable	0			0				
$t_s(L)$	LOW Data to Enable	0			0				
$t_h(H)$	HIGH Data to Enable	10			10				
$t_h(L)$	LOW Data to Enable	10			10				
t_{pw}	Enable Pulse Width	15			15				
t_{ZH}	\overline{OE} to Y_i			28			28	ns	$C_L = 5\text{pF}$ $R_L = 667\Omega$
t_{ZL}				36			36		
t_{HZ}	\overline{OE} to Y_i			20			20		
t_{LZ}				25			25		

2

Am25LS373 ONLY
SWITCHING CHARACTERISTICS
OVER OPERATING RANGE

Parameters	Description	Am25LS COM'L		Am25LS MIL		Units	Test Conditions
		Min.	Max.	Min.	Max.		
		$T_A = 0^\circ\text{C to } +70^\circ\text{C}$ $V_{CC} = 5.0\text{V} \pm 5\%$		$T_A = -55^\circ\text{C to } +125^\circ\text{C}$ $V_{CC} = 5.0\text{V} \pm 10\%$			
t_{PLH}	Enable to Output		35		40	ns	$C_L = 45\text{pF}$ $R_L = 667\Omega$
t_{PHL}				35			
t_{PLH}	Data Input to Output		19		20	ns	
t_{PHL}				20			
$t_s(H)$	HIGH Data to Enable	0		0		ns	
$t_s(L)$	LOW Data to Enable	0		0			
$t_h(H)$	HIGH Data to Enable	11		12		ns	
$t_h(L)$	LOW Data to Enable	15		17			
t_{pw}	Enable Pulse Width	17		20		ns	
t_{ZH}	\overline{OE} to Y_i		28		28	ns	$C_L = 5\text{pF}$ $R_L = 667\Omega$
t_{ZL}				36			
t_{HZ}	\overline{OE} to Y_i		33		36	ns	
t_{LZ}				33			

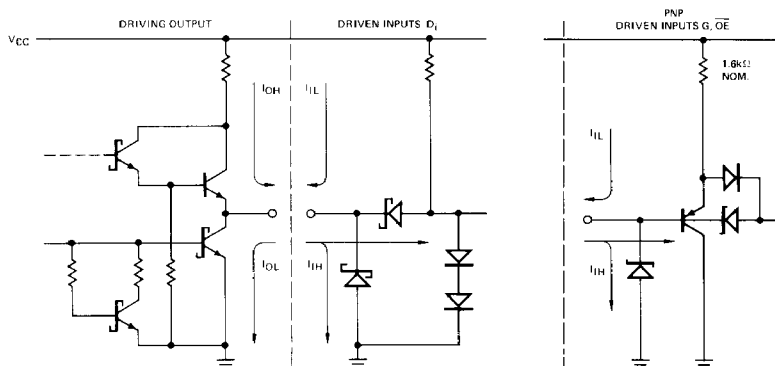
Am25LS • Am54LS/74LS
LOW-POWER SCHOTTKY INPUT/OUTPUT
CURRENT INTERFACE CONDITIONS

Note: Actual current flow direction shown.

BLI-044

Am25LS/54LS/74LS373/533

Am25LS/54LS/74LS533
SWITCHING CHARACTERISTICS

(T_A = +25°C, V_{CC} = 5.0V)

Parameters	Description	Am25LS/54LS/74LS			Units	Test Conditions
		Min	Typ	Max		
t _{PLH}	Enable to Output		20	30	ns	C _L = 45pF R _L = 667Ω
t _{PHL}			18	30		
t _{PLH}	Data Input to Output		13	20	ns	
t _{PHL}			15	23		
t _s (H)	HIGH Data to Enable	3			ns	
t _s (L)	LOW Data to Enable	0				
t _h (H)	HIGH Data to Enable	13			ns	
t _h (L)	LOW Data to Enable	7				
t _{pw}	Enable Pulse Width	15			ns	
t _{ZH}	OE to Y _i			28	ns	
t _{ZL}				36		
t _{HZ}	OE to Y _i			20	ns	C _L = 5pF R _L = 667Ω
t _{LZ}				25		

Am25LS533 ONLY
SWITCHING CHARACTERISTICS
OVER OPERATING RANGE

Parameters	Description	Am25LS COM'L		Am25LS MIL		Units	Test Conditions
		T _A = 0°C to +70°C V _{CC} = 5.0V ±5%		T _A = -55°C to +125°C V _{CC} = 5.0V ±10%			
		Min.	Max.	Min.	Max.		
t _{PLH}	Enable to Output		35		40	ns	C _L = 45pF R _L = 667Ω
t _{PHL}			35		40		
t _{PLH}	Data Input to Output		20		21	ns	
t _{PHL}			25		30		
t _s (H)	HIGH Data to Enable	5		5		ns	
t _s (L)	LOW Data to Enable	0		0			
t _h (H)	HIGH Data to Enable	14		15		ns	
t _h (L)	LOW Data to Enable	9		10			
t _{pw}	Enable Pulse Width	17		20		ns	
t _{ZH}	OE to Y _i		28		28	ns	
t _{ZL}			36		36		
t _{HZ}	OE to Y _i		33		36	ns	C _L = 5pF R _L = 667Ω
t _{LZ}			33		36		

ORDERING INFORMATION

Package Type	Temperature Range	Am25LS373 Order Number	Am54LS/74LS373 Order Number	Am25LS533 Order Number	Am54LS/74LS533 Order Number
Molded DIP	0°C to +70°C	AM25LS373PC	SN74LS373N	AM25LS533PC	SN74LS533N
Hermetic DIP	0°C to +70°C	AM25LS373DC	SN74LS373J	AM25LS533DC	SN74LS533J
Dice	0°C to +70°C	AM25LS373XC	SN74LS373X	AM25LS533XC	SN74LS533X
Hermetic DIP	-55°C to +125°C	AM25LS373DM	SN54LS373J	AM25LS533DM	SN54LS533J
Hermetic Flat Pak	-55°C to +125°C	AM25LS373FM	SN54LS373W	AM25LS533FM	SN54LS533W
Dice	-55°C to +125°C	AM25LS373XM	SN54LS373X	AM25LS533XM	SN54LS533X

Metallization and Pad Layouts

Am25LS/54LS/74LS373

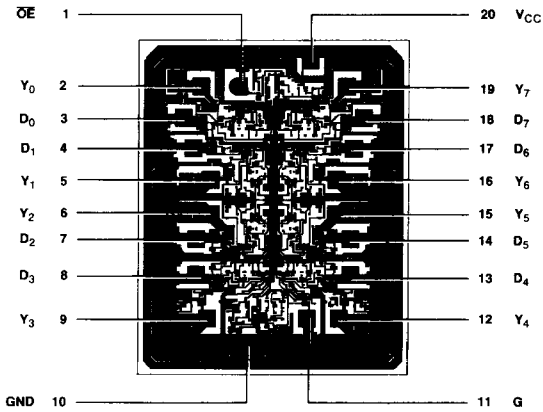

Am25LS/54LS/74LS533

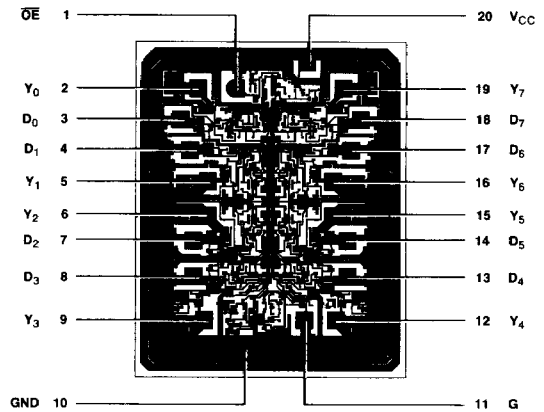

DIE SIZE 0.073" X 0.089"

APPLICATION

