

## DS2003/DS9667/DS2004 High Current/Voltage Darlington Drivers

### General Description

The DS2003/DS9667/DS2004 are comprised of seven high voltage, high current NPN Darlington transistor pairs. All units feature common emitter, open collector outputs. To maximize their effectiveness, these units contain suppression diodes for inductive loads and appropriate emitter base resistors for leakage.

The DS2003/DS9667 has a series base resistor to each Darlington pair, thus allowing operation directly with TTL or CMOS operating at supply voltages of 5.0V.

The DS2004 has an appropriate input resistor to allow direct operation from CMOS or PMOS outputs operating from supply voltages of 6.0V to 15V.

The DS2003/DS9667/DS2004 offer solutions to a great many interface needs, including solenoids, relays, lamps, small motors, and LEDs. Applications requiring sink currents beyond the capability of a single output may be accommodated by paralleling the outputs.

### Features

- Seven high gain Darlington pairs
- High output voltage ( $V_{CE} = 50V$ )
- High output current ( $I_C = 350\text{ mA}$ )
- TTL, PMOS, CMOS compatible
- Suppression diodes for inductive loads
- Extended temperature range

### Connection Diagram

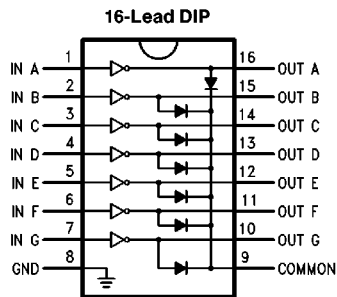

Top View

TL/F/9647-1

### Order Numbers

	J Package Number J16A	N Package Number N16E	M Package Number M16A
DS2003 DS9667	DS2003MJ DS2003TJ DS2003CJ DS9667MJ DS9667TJ DS9667CJ	DS2003TN DS2003CN DS9667TN DS9667CN	DS2003TM DS2003CM
DS2004	DS2004MJ DS2004TJ DS2004CJ	DS2004TN DS2004CN	DS2004TM DS2004CM

## Absolute Maximum Ratings (Note 1)

If Military/Aerospace specified devices are required, please contact the National Semiconductor Sales Office/Distributors for availability and specifications.

Storage Temperature Range	
Ceramic DIP	-65°C to +175°C
Molded DIP	-65°C to +150°C
Operating Temperature Range	
DS2003M/DS9667M	-55°C to +125°C
DS2004M	-55°C to +125°C
DS2003T/DS9667T	-40°C to +105°C
DS2004T	-40°C to +105°C
DS2003C/DS9667C	0°C to +85°C
DS2004C	0°C to +85°C

Lead Temperature	
Ceramic DIP (Soldering, 60 seconds)	300°C
Molded DIP (Soldering, 10 seconds)	265°C
Maximum Power Dissipation* at 25°C	
Cavity Package	2016 mW
Molded Package	1838 mW
S.O. Package	926 mW
*Derate cavity package 16.13 mW/°C above 25°C; derate molded DIP package 14.7 mW/°C above 25°C. Derate S.O. package 7.4 mW/°C.	
Input Voltage	30V
Output Voltage	55V
Emitter-Base Voltage	6.0V
Continuous Collector Current	500 mA
Continuous Base Current	25 mA

## Electrical Characteristics $T_A = 25^\circ\text{C}$ , unless otherwise specified (Note 2)

Symbol	Parameter	Conditions	Min	Typ	Max	Units
$I_{CEX}$	Output Leakage Current	$T_A = 25^\circ\text{C}, V_{CE} = 50\text{V}$ (Figure 1a)			20	$\mu\text{A}$
		$T_A = 85^\circ\text{C}, V_{CE} = 50\text{V}$ (Figure 1a) for Commercial Grade			100	
		$T_A = 25^\circ\text{C}, V_{CE} = 50\text{V}, V_I = 1.0\text{V}$ (Figure 1b) DS2004			500	
$V_{CE(Sat)}$	Collector-Emitter Saturation Voltage	$I_C = 350\text{ mA}, I_B = 500\ \mu\text{A}$ (Figure 2) (Note 3)		1.25	1.6	V
		$I_C = 200\text{ mA}, I_B = 350\ \mu\text{A}$ (Figure 2)		1.1	1.3	
		$I_C = 100\text{ mA}, I_B = 250\ \mu\text{A}$ (Figure 2)		0.9	1.1	
$I_{I(ON)}$	Input Current	$V_I = 3.85\text{V}$ (Figure 3) DS2003/DS9667		0.93	1.35	mA
		$V_I = 5.0\text{V}$ (Figure 3) DS2004		0.35	0.5	
		$V_I = 12\text{V}$ (Figure 3)		1.0	1.45	
$I_{I(OFF)}$	Input Current (Note 4)	$T_A = 85^\circ\text{C}$ for Commercial $I_C = 500\ \mu\text{A}$ (Figure 4)	50	100		$\mu\text{A}$
$V_{I(ON)}$	Input Voltage (Note 5)	$V_{CE} = 2.0\text{V}, I_C = 200\text{ mA}$ (Figure 5) DS2003/DS9667			2.4	V
		$V_{CE} = 2.0\text{V}, I_C = 250\text{ mA}$ (Figure 5)			2.7	
		$V_{CE} = 2.0\text{V}, I_C = 300\text{ mA}$ (Figure 5)			3.0	
		$V_{CE} = 2.0\text{V}, I_C = 125\text{ mA}$ (Figure 5) DS2004			5.0	
		$V_{CE} = 2.0\text{V}, I_C = 200\text{ mA}$ (Figure 5)			6.0	
		$V_{CE} = 2.0\text{V}, I_C = 275\text{ mA}$ (Figure 5)			7.0	
		$V_{CE} = 2.0\text{V}, I_C = 350\text{ mA}$ (Figure 5)			8.0	
$C_I$	Input Capacitance			15	30	pF
$t_{PLH}$	Turn-On Delay	$0.5 V_I$ to $0.5 V_O$			1.0	$\mu\text{s}$
$t_{PHL}$	Turn-Off Delay	$0.5 V_I$ to $0.5 V_O$			1.0	$\mu\text{s}$
$I_R$	Clamp Diode Leakage Current	$V_R = 50\text{V}$ (Figure 6)	$T_A = 25^\circ\text{C}$		50	$\mu\text{A}$
			$T_A = 85^\circ\text{C}$		100	$\mu\text{A}$
$V_F$	Clamp Diode Forward Voltage	$I_F = 350\text{ mA}$ (Figure 7)		1.7	2.0	V

**Note 1:** "Absolute Maximum Ratings" are those values beyond which the safety of the device cannot be guaranteed. They are not meant to imply that the devices should be operated at these limits. The tables of "Electrical Characteristics" provide conditions for actual device operation.

**Note 2:** All limits apply to the complete Darlington series except as specified for a single device type.

**Note 3:** Under normal operating conditions these units will sustain 350 mA per output with  $V_{CE(Sat)} = 1.6\text{V}$  at  $70^\circ\text{C}$  with a pulse width of 20 ms and a duty cycle of 30%.

**Note 4:** The  $I_{I(OFF)}$  current limit guaranteed against partial turn-on of the output.

**Note 5:** The  $V_{I(ON)}$  voltage limit guarantees a minimum output sink current per the specified test conditions.

# Typical Performance Characteristics

**Collector Current vs Saturation Voltage**

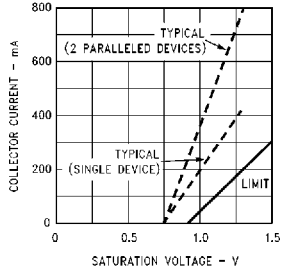

**Collector Current vs Input Current**

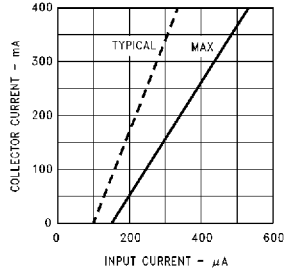

**DS2003/DS9667  
Input Current vs Input Voltage**

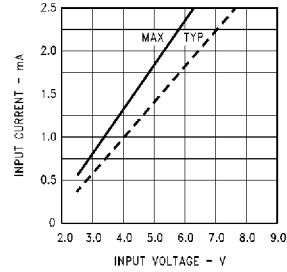

**DS2004  
Input Current vs Input Voltage**

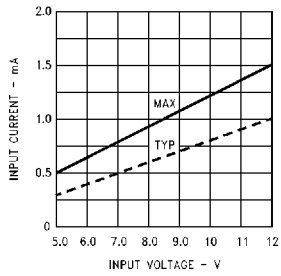

**Peak Collector Current vs Duty Cycle and Number of Outputs (Molded Package)**

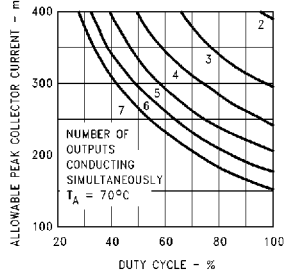

**Peak Collector Current vs Duty Cycle and Number of Outputs (Ceramic Package)**

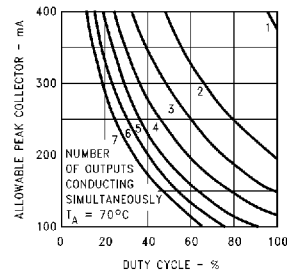

TL/F/9647-6

## Equivalent Circuits

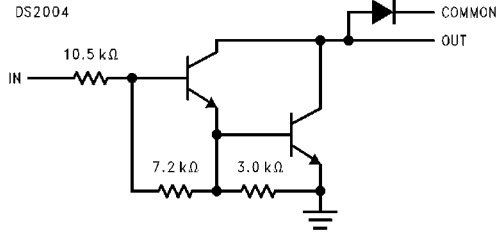
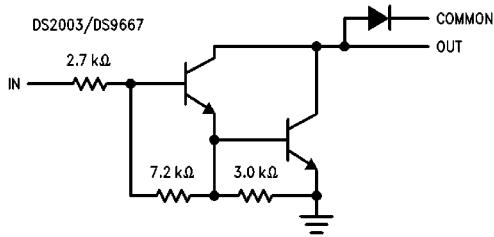

## Test Circuits

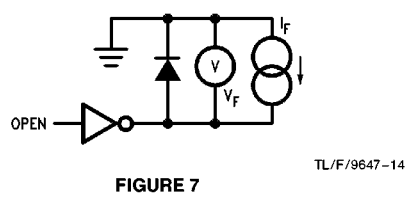
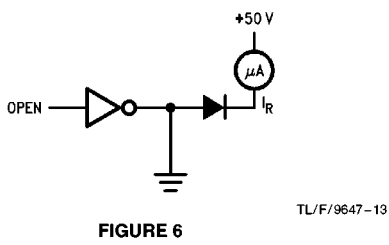
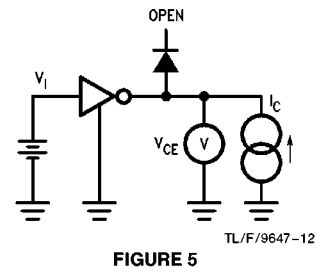
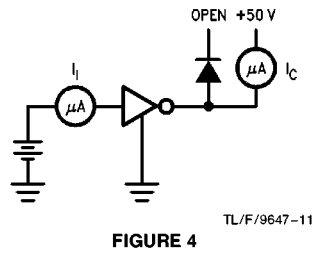
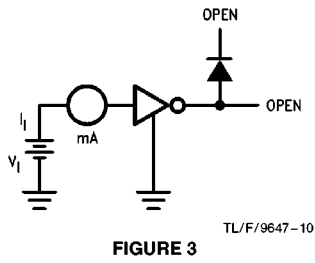
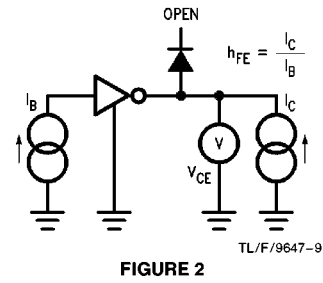
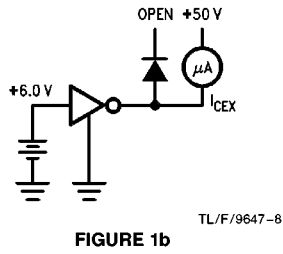
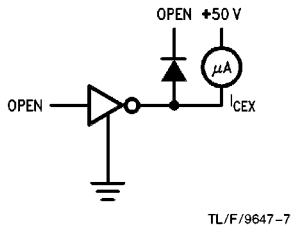

## Typical Applications

Buffer for Higher Current Loads

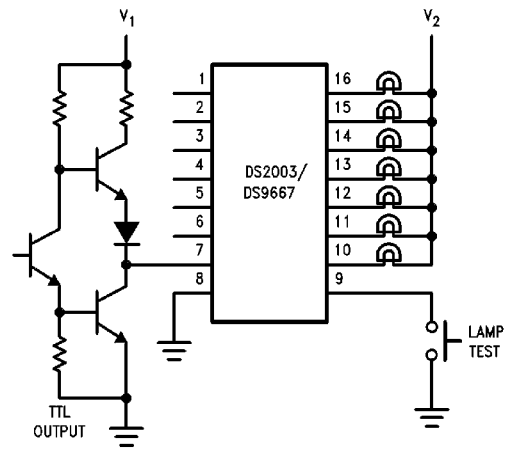

TL/F/9647-16

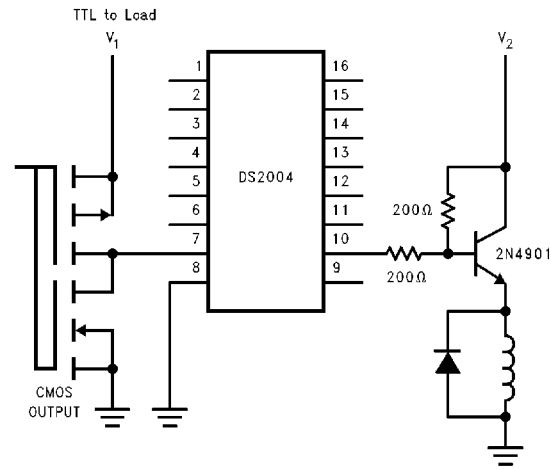

TL/F/9647-17

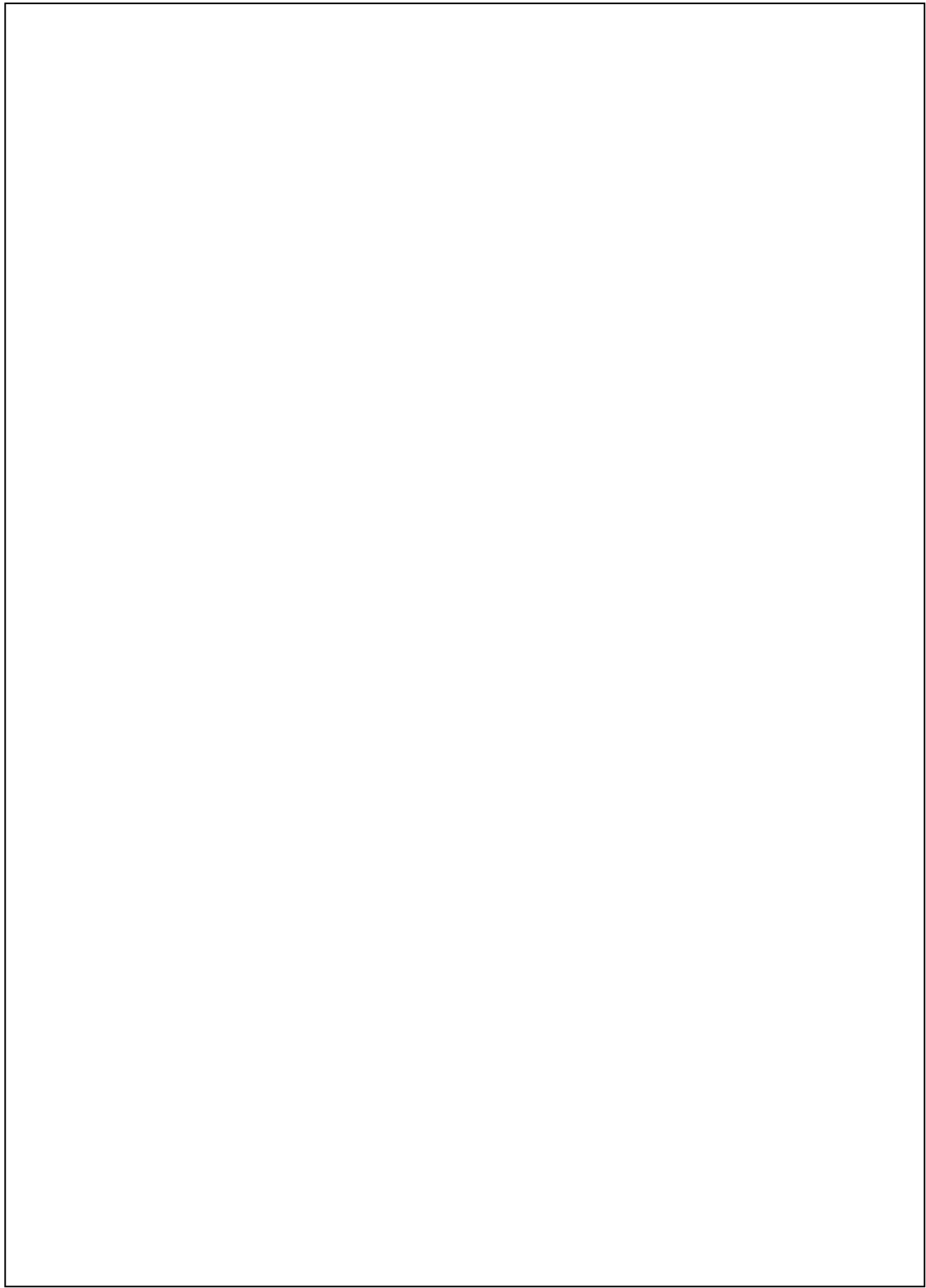

**Physical Dimensions** inches (millimeters) unless otherwise noted

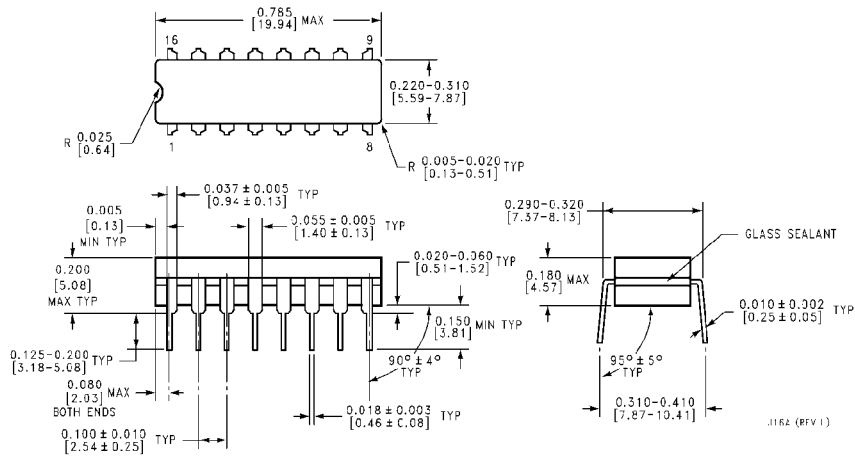

**Ceramic Dual-In-Line Package (J)**  
**Order Number DS2003CJ, DS9667CJ, DS2003MJ, D9667MJ,**  
**DS2003TJ, DS9667TJ, DS2004CJ, DS2004MJ or DS2004TJ**  
**NS Package Number J16A**

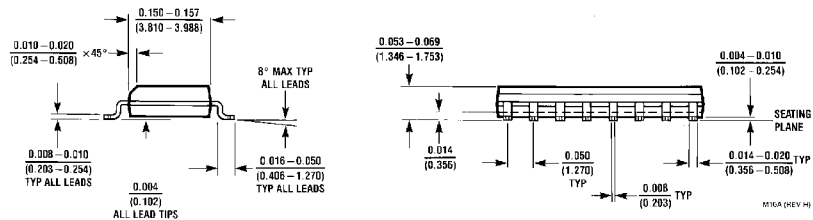
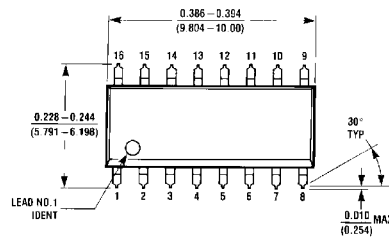

**Surface Mount Package (M)**  
**Order Number DS2003CM, DS9667CM, DS2003TM, DS9667TM, DS2004CM or DS2004TM**  
**NS Package Number M16A**

**Physical Dimensions** inches (millimeters) unless otherwise noted (Continued)

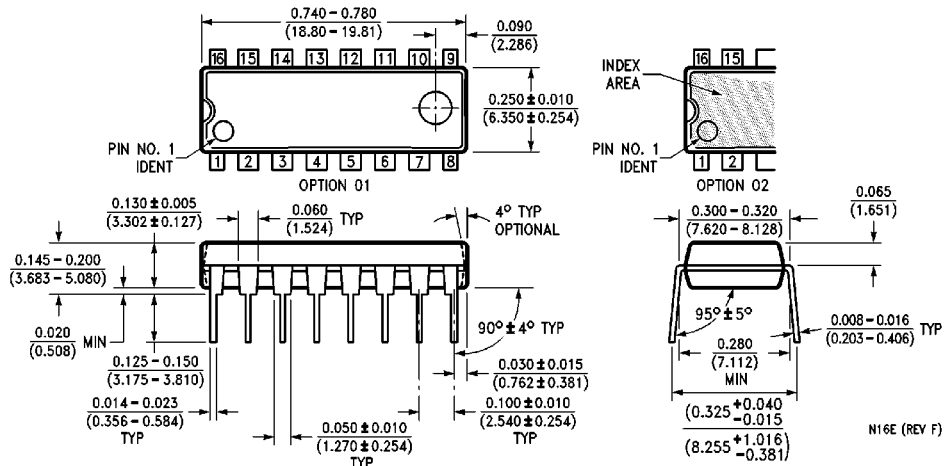

**Molded Dual-In-Line Package (N)**

Order Number DS2003CN, DS9667CN, DS2003TN, DS9667TN, DS2004CN or DS2004TN  
NS Package Number N16E

**LIFE SUPPORT POLICY**

NATIONAL'S PRODUCTS ARE NOT AUTHORIZED FOR USE AS CRITICAL COMPONENTS IN LIFE SUPPORT DEVICES OR SYSTEMS WITHOUT THE EXPRESS WRITTEN APPROVAL OF THE PRESIDENT OF NATIONAL SEMICONDUCTOR CORPORATION. As used herein:

1. Life support devices or systems are devices or systems which, (a) are intended for surgical implant into the body, or (b) support or sustain life, and whose failure to perform, when properly used in accordance with instructions for use provided in the labeling, can be reasonably expected to result in a significant injury to the user.
2. A critical component is any component of a life support device or system whose failure to perform can be reasonably expected to cause the failure of the life support device or system, or to affect its safety or effectiveness.



**National Semiconductor Corporation**  
1111 West Bardin Road  
Arlington, TX 76017  
Tel: 1(800) 272-9959  
Fax: 1(800) 737-7018

<http://www.national.com>

**National Semiconductor Europe**

Fax: +49 (0) 180-530 85 86  
Email: [europe.support@nsc.com](mailto:europe.support@nsc.com)  
Deutsch Tel: +49 (0) 180-530 85 85  
English Tel: +49 (0) 180-532 78 32  
Français Tel: +49 (0) 180-532 93 58  
Italiano Tel: +49 (0) 180-534 16 80

**National Semiconductor Hong Kong Ltd.**

13th Floor, Straight Block,  
Ocean Centre, 5 Canton Rd.  
Tsimshatsui, Kowloon  
Hong Kong  
Tel: (852) 2737-1600  
Fax: (852) 2736-9960

**National Semiconductor Japan Ltd.**

Tel: 81-043-299-2308  
Fax: 81-043-299-2408

National does not assume any responsibility for use of any circuitry described, no circuit patent licenses are implied and National reserves the right at any time without notice to change said circuitry and specifications.