

***THIS DOCUMENT IS FOR MAINTENANCE
PURPOSES ONLY AND IS NOT
RECOMMENDED FOR NEW DESIGNS***

SL1521

300MHz WIDEBAND LOG AMPLIFIER

The SL1521A and C are wideband amplifiers intended for use in successive detection logarithmic IF strips operating at centre frequencies of up to 200MHz. It is a plug in replacement for the SL521 series of RF amplifiers. The midband voltage gain of the SL1521 is typically 12dB. The SL1521A and C differ mainly in the tolerance of voltage gain.

APPLICATIONS

- Radar IF strips
- Wideband Amplification

ABSOLUTE MAXIMUM RATINGS (Non-simultaneous)

Storage temperature range	-55°C to +150°C
Operating temperature range	-55°C to +125°C
Maximum chip operating resistance	150°C
Chip to ambient thermal resistance	250°C/W

Test circuits: see Fig.8

ORDERING INFORMATION

- SL1521 A CM
- SL1521 AB CM
- SL1521 C CM
- SL1521 CB CM

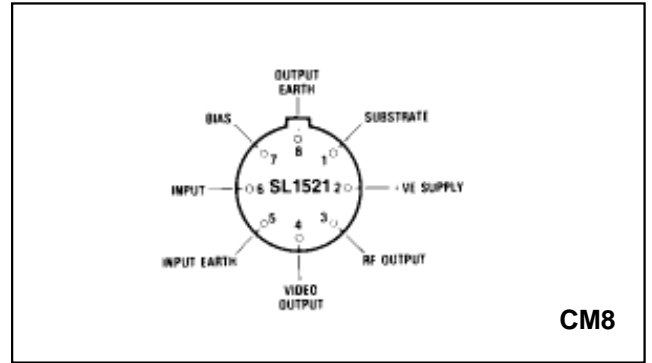

Fig.1 Pin connections

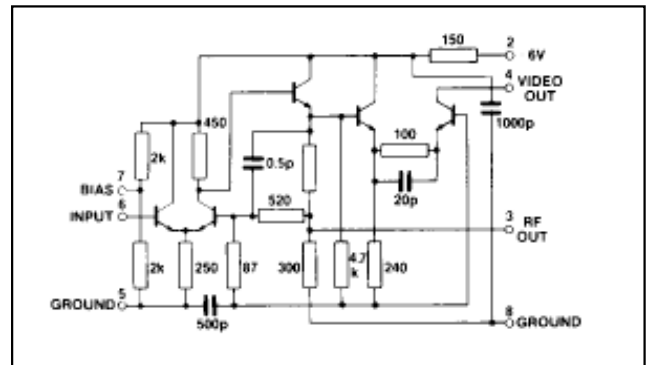

Fig.2 Circuit diagram

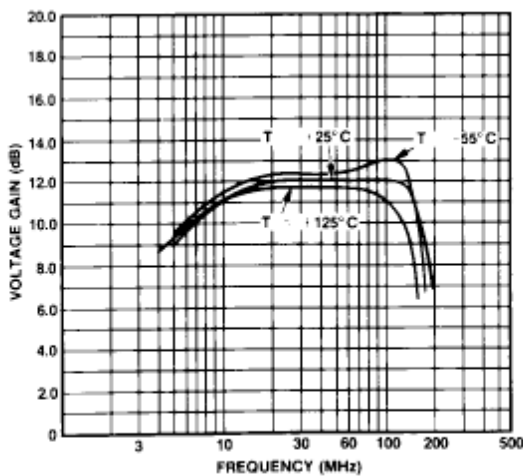

Fig.3 Voltage gain v. frequency

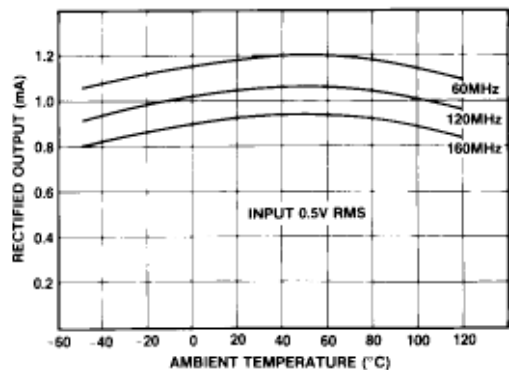

Fig.4 Maximum rectified output current v. temperature

SL1521

ELECTRICAL CHARACTERISTICS

Test conditions (unless otherwise stated):

Temperature = +22°C ± 2°C

Supply voltage = +5.2V

DC connection between input and bias pins

Characteristic	Circuits	Value			Units	Conditions
		Min.	Typ.	Max.		
Voltage gain, f = 120MHz	SL1521A	11.5		12.5	dB	} 3mV rms input 50 ohms source 8pF load + 500Ω
	SL1521AC	10.8		13.1	dB	
Voltage gain, f = 160MHz	SL1521A	11.2		12.8	dB	
	SL1521C	10.6		13.4	dB	
Upper cut-off frequency	SL1521A	250	285		MHz	50 ohms source
	SL1521C		285		MHz	
Lower cut-off frequency	All types		6	10	MHz	50 ohms source
Propagation delay	All types		0.6		ns	
Maximum rectified video output current	SL1521A	0.95		1.05	mA	} f = 120MHz 0.5V rms input 8pF load, 500 ohms in parallel
	SL1521C	0.90		1.20	mA	
Variation of gain with supply voltage	All types		1.0		dB/V	
Variation of maximum rectified output current with supply voltage	All types		30		%V	
Maximum input signal before overload	All types		1.5		V rms	See note below f = 120MHz, source resistance optimised
Noise figure			4.5	6.0	dB	
Supply current	All types	10.0	15.0	20.0	mA	resistance optimised
Maximum RF output voltage	All types	1.0			V p-p	f = 120MHz

OPERATING NOTES

The amplifiers are intended for use directly coupled, as shown in Fig 7

The seventh stage in an untuned cascade will be giving virtually full output on noise.

Noise may be reduced by inserting a single tuned circuit in the chain. As there is a large mismatch between stages a simple shunt or series circuit cannot be used. The choice of network is also controlled by the need to avoid distorting the logarithmic law; the network must give unity voltage transfer at resonance. A suitable network is shown in Fig. 8. The value of C1 must be chosen so that at resonance its admittance equals the total loss conductance across the tuned circuit.

A simple capacitor may not be suitable for decoupling the output line if many stages and fast rise times are required. Values of positive supply line decoupling capacitor required for untuned cascades are given below. Smaller values can be used in high frequency tuned cascades.

The amplifiers have been provided with two earth leads to avoid the introduction of common earth lead inductance between input and output circuits. The equipment designer should take care to avoid the subsequent introduction of such inductance.

	Number of stages			
	6 or more	5	4	3
Minimum capacitance	30nF	10nF	3nF	1nF

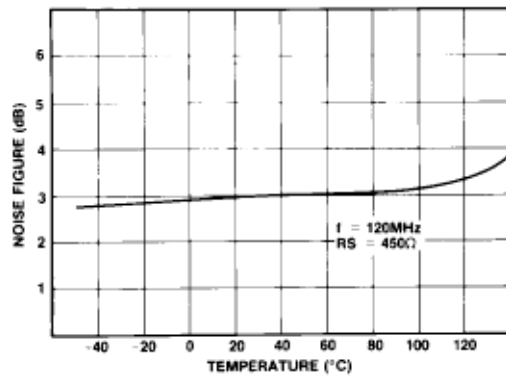

Fig.5 Typical noise figure v. temperature

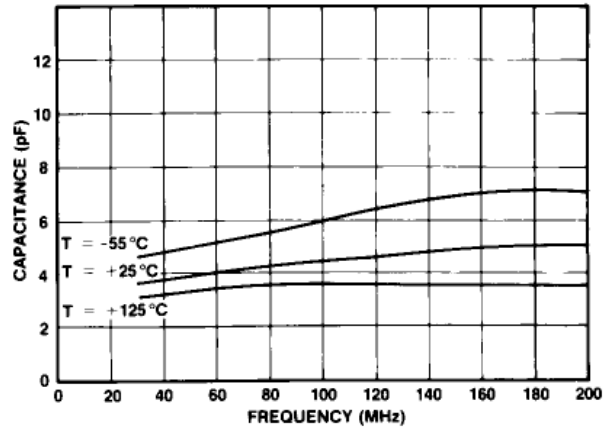

Fig.6 Input admittance with open-circuit output

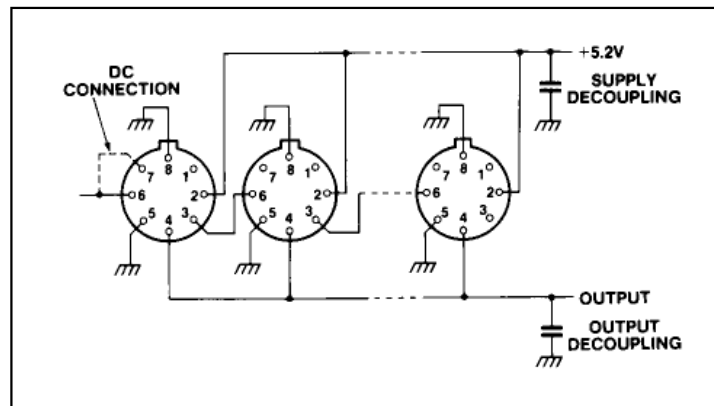

Fig.7 Direct coupled amplifier

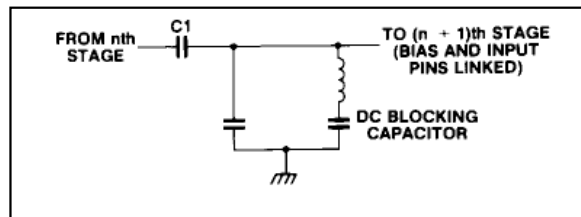

Fig.8 Suitable interstage tuned circuit