

# Series SMA

Precision coaxial connector for microwave applications. The maximum frequency is 24 GHz, recommended frequency range up to 18 GHz. SMA connectors satisfy high quality standards and are characterized by high reliability, high mechanical stability, long life, and optimum electrical properties, especially low VSWR.

The connectors are available in various quality classes for different applications, with the outer conductor manufactured from different materials and therefore with different price levels:

- standard quality gold plated beryllium copper,
- gold plated stainless steel and
- low cost version in nickel-plated brass.

Straight and angled connectors are available for cable with diameters from 1.2 mm to 6.3 mm. In addition, connectors are available in a variety of panel types, for printed circuit boards or for microwave applications. e.g. microstrip or planar waveguide.

Design in accordance with: IEC 169-15  
CECC 22 110  
US MIL-C-39012  
BS9210N0006

Quality tested in accordance with: US MIL-Std 202

Cable mounting: clamp and crimp versions,  
soldered for semi-rigid cables

Special versions: connectors for PCB applications  
(solder, press-fit and SMT), connectors  
for planar structures (e.g. microstrip),  
hermetically sealed versions

# Serie SMA

Miniatur-Koaxialsteckverbinder in Präzisionsausführung für Mikrowellenanwendungen im Frequenzbereich bis 18 GHz (24 GHz). Sie besitzen einen hohen Qualitätsstandard und zeichnen sich durch Zuverlässigkeit, große mechanische Festigkeit, lange Lebensdauer und optimale elektrische Eigenschaften, insbesondere niedriges VSWR, aus.

Für verschiedene Einsatzfälle werden die Steckverbinder mit unterschiedlicher Materialauswahl für die Außenleiterteile und daraus folgender Qualitätsstaffelung und verschiedener Preisabstufung angeboten:

- die Standardausführung in vergoldetem Kupfer-Beryllium,
- eine Ausführung in vergoldetem Edelstahl und
- eine low-cost-Ausführung in Messing vernickelt.

Lieferbar sind Stecker in gerader und Winkel-Ausführung für Kabel mit Durchmesser von 1,2 mm bis 6,3 mm. Ferner sind Stecker für Gehäusemontage, gedruckte Schaltungen oder für Mikrowellenanwendungen, z.B. Microstrip oder planare Strukturen erhältlich.

Anschlußdimensionen nach: IEC 169-15  
CECC 22 110  
US MIL-C-39012  
BS9210N0006

Qualitätsprüfung nach: US MIL-STD 202

Kabelmontage: Klemm- und Crimpverbindung,  
Lötverbindung für semi-rigid Kabel

Spezialausführungen: Elemente für Leiterplatten (Löt- und  
Einpreßtechnik) Bauformen für planare  
Strukturen (z.B. Mikrostrip)  
hermetische Ausführungen

## Mechanical Characteristics

## Anschlußmaße

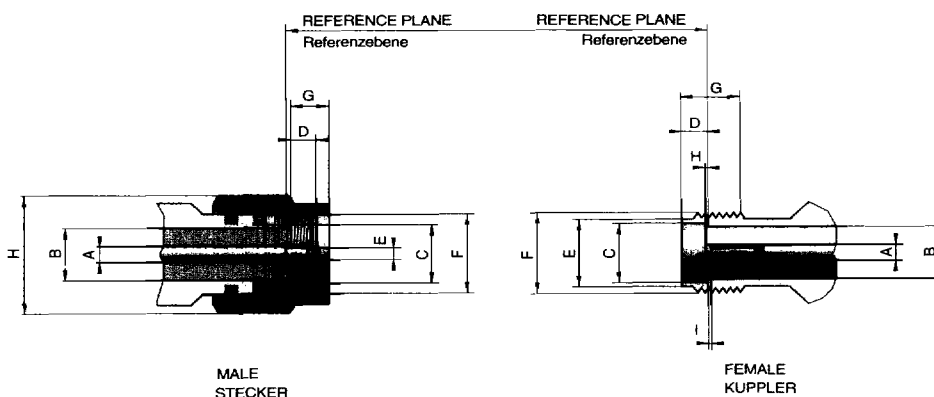

SMA (50 Ohm) Serie 32					
	MALE STECKER		FEMALE KUPPLER		
	min.	max.	min.	max.	
A	1.245	1.295	1.245	1.295 1)2)	A
B		4.178		4.178 1)	B
C		4.59	4.60	4.67	C
D		2.54	1.88	1.98	D
E	0.902	0.940	5.28	5.49	E
F	1/4-36 UNS-2B		1/4-36 UNS-2B		F
G	3.43		4.32		G
H	HEX 5/16"		0.05		H
I			0.05	0.25	I

1) Contact diameters refer to 75 Ohm Durchmesser Innenleiter/Außenleiter müssen 75 Ohm entsprechen  
2) resilient, dim. to meet electrical and mechanical requirements federn zusammenggezogen (Erfüllung elektr./mech. Forderungen)

## Technical Characteristics SMA

## Technische Daten SMA

Electrical characteristics		Elektrische Daten	
Characteristic impedance	50 Ω	Wellenwiderstand	
Frequency range (straight connectors)		Frequenzbereich (gerade Steckverbinder)	
max.	0...24 GHz	max.	
recommended	0...18 GHz	empfohlen	
typ. VSWR (straight connectors)	≤ 1.1 0...18 GHz ≤ 1.2 18...24 GHz	VSWR (gerade Steckverbinder)	
VSWR class 1	1.05 + 0.005 x f (GHz)	VSWR Klasse 1	
VSWR class 2	1.07 + 0.005 x f (GHz)	VSWR Klasse 2	
VSWR class 3	1.10 + 0.010 x f (GHz)	VSWR Klasse 3	
VSWR class 4	1.10 + 0.020 x f (GHz)	VSWR Klasse 4	
VSWR class 5	1.15 + 0.010 x f (GHz)	VSWR Klasse 5	
VSWR class 6	1.15 + 0.020 x f (GHz)	VSWR Klasse 6	
VSWR class 7	1.20 + 0.020 x f (GHz)	VSWR Klasse 7	
Insertion loss (dB)	0.1 dB max. /1GHz typ.	Dämpfung (dB)	
Insulation resistance	≥ 5000 MΩ	Isolationswiderstand	
Center contact resistance	≤ 3.0 mΩ	Übergangswiderstand Innenleiter	
Outer contact resistance	≤ 2.0 mΩ	Übergangswiderstand Außenleiter	
Test voltage	1000 V rms	Prüfspannung	
Working voltage	480 V rms	Betriebsspannung	
Contact current	≤ 2 A DC typ.	Strombelastbarkeit	
Power handling	typ. 100 W / 10 GHz, 25°C; VSWR=1	Leistungsbelastbarkeit	
RF-leakage (dB)	≥ 100	Schirmdämpfung (dB)	
Mechanical characteristics		Mechanische Daten	
Coupling torque	St. Steel/BeCu / Brass	Anzugsdrehmoment	
min.	60 Ncm / 12 Ncm	min.	
max.	170 Ncm / 60 Ncm	max.	
recommended	90 Ncm / 50 Ncm	empfohlen	
Coupling nut retention	≥ 300 N	Haltekraft, Überwurfmutter	
Center contact retention force	≥ 22 N	Innenleiter Haltekraft	
Connecting operations	≥ 500	Anzahl Steckzyklen	
Environmental		Umgebungseinflüsse	
Temperature range	-65°C - +165°C	Temperaturbereich	
Vibration	MIL-STD-202 Meth. 204/B	Vibration	
Shock	MIL-STD-202 Meth. 204/D	Schock	
Humidity	MIL-STD-202 Meth. 106/B	Feuchtigkeit	
Corrosion resistance	MIL-STD-202 Meth. 101	Korrosionsbeständigkeit	
Climatic Class according IEC	IEC 55 / 155 / 21	Klimaklasse nach IEC	
Temperature cycle	MIL-STD-202 Meth. 102/C	Temperatur Zyklen	
Materials		Materialien	
Body	CuBe2 / Stainless steel / Brass	Außenleiter	
Spring loaded contacts	CuBe	federnde Kontaktteile	
Insulator	PTFE	Isolator	
Crimping ferrules	copper alloy	Krimphülse	
Gaskets	Rubber	Dichtungen	
Plating body contact area	Au	Oberfläche Kontaktzone Außenleiter	
Plating center contact area	Au	Oberfläche Kontaktzone Innenleiter	

**CABLE CONNECTORS**

**1. SEMI-RIGID CABLE**

**STRAIGHT PLUG, Solder**

**STECKER, löt**

Part Number	VSWR Class	Cable Group	Assembly Instruction	MIL-Std - C39012	Remarks
<b>without pin, without insulator gold plated</b>					
32 S 101-272 D	1	72	32 A1	792-4001	a = 8.4
32 S 103-272 D	1	72	32 A1		a = 11.5
<b>stainless steel</b>					
32 S 121-272 S	1	72	32 A1	792-3001	a = 8.4
32 S 123-272 S	1	72	32 A1		a = 11.5
<b>economy</b>					
32 S 141-272 N		72	32 A1		a = 8.4
32 S 143-272 N		72	32 A1		a = 11.5



**STRAIGHT PLUG, Solder**

**STECKER, löt**

Part Number	VSWR Class	Cable Group	Assembly Instruction	MIL-Std - C39012	Remarks
<b>soldered center contact gold plated</b>					
32 S 101-270 D3	3	70	32 A11		a = 14.7
32 S 102-271 D3	2	71	32 A6	779-4005	a = 11.2
32 S 102-272 D3	1	72	32 A3	779-4006	a = 11.2
<b>stainless steel</b>					
32 S 121-270 S3	3	70	32 A11		a = 14.7
32 S 122-271 S3	2	71	32 A6	779-3005	a = 11.2
32 S 122-272 S3	1	72	32 A3	779-3006	a = 11.2
32 C 068-271 S3	2	71	32 A6		a = 9.5
32 C 081-272 S3	1	72	32 A3		a = 8.7
<b>economy</b>					
32 S 142-271 N3		71	32 A6		a = 11.2
32 S 142-272 N3		72	32 A3		a = 11.2

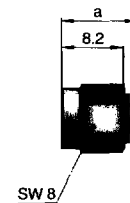

**STRAIGHT PLUG, Clamp**

**STECKER gerade, klemm**

Part Number	VSWR Class	Cable Group	Assembly Instruction	MIL-Std - C39012	Remarks
32 S 106-073 D3	1	73	32 C1		captive center conductor

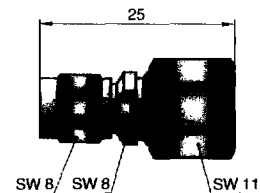

**RIGHT ANGLE PLUG, Solder**

**WINKELSTECKER, löt**

Part Number	VSWR Class	Cable Group	Assembly Instruction	MIL-Std. C39012	Remarks
32 S 206-271 D3	3	71	32 E 1	/80-4007	captivated center conductor
32 S 206-272 D3	3	72	32 E 1	/80-4008	captivated center conductor

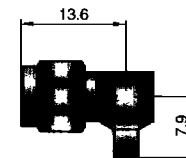

**STRAIGHT JACK, Solder**

**KUPPLER gerade, löt**

Part Number	VSWR Class	Cable Group	Assembly Instruction	MIL-Std. C39012	Remarks
32 K 101-271 D3	3	71	32 A4	/81-4005	
32 K 101-272 D3	3	72	32 A5	/81-4006	

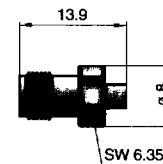

**FLANGE JACK, Solder**

**FLANSCHKUPPLER, löt**

Part Number	VSWR Class	Cable Group	Assembly Instruction	MIL-Std. C39012	Panel Piercing	Remarks
32 K 401-271 D3	3	71	32 A4	/82-4005	B 55	
32 K 401-272 D3	3	72	32 A5	/82-4006	B 55	

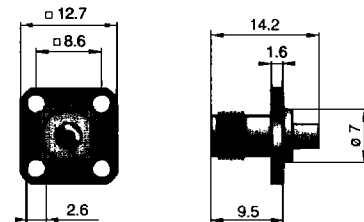

**BULKHEAD JACK, Solder**

**GEHÄUSEKUPPLER, löt**

Part Number	VSWR Class	Cable Group	Assembly Instruction	MIL-Std. C39012	Panel Piercing	Remarks
32 K 601-271 D3	3	71	32 A5	/81-4005	B 56	
32 K 601-272 D3	3	72	32 A5	/81-4006	B 56	

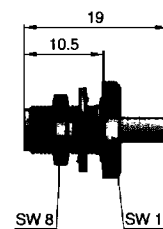

**STRAIGHT JACK, Clamp**

**KUPPLER gerade, klemm**

Part Number	VSWR Class	Cable Group	Assembly Instruction	MIL-Std. C39012	Remarks
32 K 106-073 D3	1	73	32 C1		

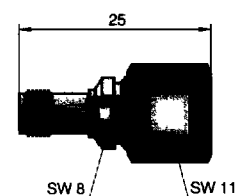

**CABLE CONNECTORS**

**2. FLEXIBLE CABLE**

**STRAIGHT PLUG, Solder-Crimp**

**STECKER, lötl-crimp**

Part Number	VSWR Class	Cable Group	Assembly Instruction	MIL-Std C39012	Crimp-Inserts	Remark
gold plated						
32 S 106-302 D3	6	02	32 B1	/55-4026	11 W 150-102	a = 22.2; b = 11
32 S 106-303 D3	5	03	32 B1		11 W 150-103	a = 22.2; b = 11
32 S 106-306 D3	5	06	32 B1	/55-4029	11 W 150-106	a = 21.7; b = 10.5
32 S 106-307 D3	5	07	32 B1	/55-4028	11 W 150-106	a = 24.7 b = 13.5
stainless steel						
32 S 126-302 D3	6	02	32 B1	/55-3026	11 W 150-102	a = 22.2; b = 11
32 S 126-303 D3	5	03	32 B1		11 W 150-103	a = 22.2; b = 11
32 S 126-306 D3	5	06	32 B1	/55-3029	11 W 150-106	a = 21.7; b = 10.5
32 S 126-307 D3	5	07	32 B1	/55-3028	11 W 150-106	a = 24.7 b = 13.5
economy						
32 S 146-302 N3		02	32 B1		11 W 150-102	a = 22.2; b = 11
32 S 146-306 N3		06	32 B1		11 W 150-106	a = 21.7; b = 10.5
32 S 146-307 N3		07	32 B1		11 W 150-106	a = 24.7 b = 13.5

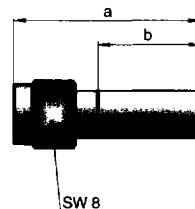

**RIGHT ANGLE PLUG, Solder-Crimp**

**WINKELSTECKER, lötl-crimp**

Part Number	VSWR Class	Cable Group	Assembly Instruction	MIL-Std C39012	Crimp-Inserts	Remark
gold plated						
32 S 206-302 D3	6	02	32 B3	/56-4026	11 W 150-102	a = 15.7; b = 11
32 S 206-303 D3	5	03	32 B3		11 W 150-103	a = 15.7; b = 11
32 S 206-306 D3	5	06	32 B3	/56-4029	11 W 150-106	a = 15.2; b = 10.5
32 S 206-307 D3	5	07	32 B3	/56-4028	11 W 150-106	a = 18.2 b = 13.5
stainless steel						
32 S 226-302 D3	6	02	32 B3	/56-3026	11 W 150-102	a = 15.7; b = 11
32 S 226-303 D3	5	03	32 B3		11 W 150-103	a = 15.7; b = 11
32 S 226-306 D3	5	06	32 B3	/56-3029	11 W 150-106	a = 15.2; b = 10.5
32 S 226-307 D3	5	07	32 B3	/56-3028	11 W 150-106	a = 18.2 b = 13.5
economy						
32 S 246-302 N3		02	32 B3		11 W 150-102	a = 15.7; b = 11
32 S 246-303 N3		03	32 B3		11 W 150-103	a = 15.7; b = 11
32 S 246-306 N3		06	32 B3		11 W 150-106	a = 15.2; b = 10.5
32 S 246-307 N3		07	32 B3		11 W 150-106	a = 18.2 b = 13.5

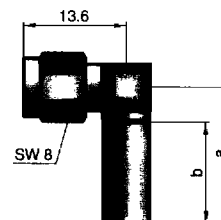

**STRAIGHT PLUG, Clamp**

**STECKER, klemm**

Part Number	VSWR Class	Cable Group	Assembly Instruction	Remark
32 S 106-002 D3	6	02/03	32 D1	
32 S 106-006 D3	5	06/07	32 D1	

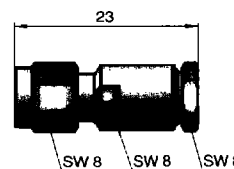

**STRAIGHT JACK, Solder-Crimp**

**KUPPLER, löt-crimp**

Part Number	VSWR Class	Cable Group	Assembly Instruction	MIL-Std. C39012	Crimp-Inserts	Remarks
gold plated						
32 K 106-302 D3	6	02	32 B1	/57-4026	11 W 150-102	a = 23
32 K 106-306 D3	5	06	32 B1	/57-4029	11 W 150-106	a = 22.5
32 K 106-307 D3	5	07	32 B1	/57-4028	11 W 150-106	a = 25.5
stainless steel						
32 K 126-302 S3	6	02	32 B1	/57-3026	11 W 150-102	a = 23
32 K 126-306 S3	5	06	32 B1	/57-3029	11 W 150-106	a = 22.5
32 K 126-307 S3	5	07	32 B1	/57-3028	11 W 150-106	a = 25.5

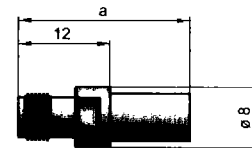

**FLANGE JACK, Solder-Crimp**

**FLANSCHKUPPLER, löt-crimp**

Part Number	VSWR Class	Cable Group	Assembly Instruction	MIL-Std. C39012	Panel Piercing	Crimp-Inserts	Remarks
gold plated							
32 K 406-302 D3	6	02	32 B1	/58-4026	B 55	11 W 150-102	a = 23; b = 11
32 K 406-306 D3	5	06	32 B1	/58-4029	B 55	11 W 150-106	a = 22.5; b = 10.5
32 K 406-307 D3	5	07	32 B1	/58-4028	B 55	11 W 150-106	a = 25.5; b = 13.5
stainless steel							
32 K 426-302 S3	6	02	32 B1	/58-3026	B 55	11 W 150-102	a = 23; b = 11
32 K 426-306 S3	5	06	32 B1	/58-3029	B 55	11 W 150-106	a = 22.5; b = 10.5
32 K 426-307 S3	5	07	32 B1	/58-3028	B 55	11 W 150-106	a = 25.5; b = 13.5

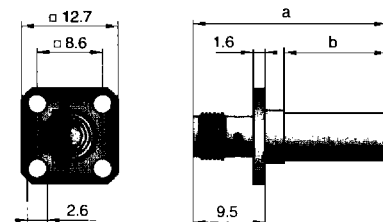

**BULKHEAD JACK, Solder-Crimp**

**GEHÄUSEKUPPLER, löt-crimp**

Part Number	VSWR Class	Cable Group	Assembly Instruction	MIL-Std. C39012	Panel Piercing	Crimp-Inserts	Remarks
gold plated							
32 K 606-302 D3	6	02	C	32 B1	B 57	11 W 150-102	a = 24; b = 11
32 K 606-303 D3	6	03	C	32 B1	B 57	11 W 150-103	a = 24; b = 11
32 K 606-306 D3	6	06	C	32 B1	B 57	11 W 150-106	a = 23.5; b = 10.5
32 K 606-307 D3	6	07	C	32 B1	B 57	11 W 150-106	a = 26.5; b = 13.5
stainless steel							
32 K 626-302 D3	6	02	C	32 B1	B 57	11 W 150-102	a = 24; b = 11
32 K 626-303 D3	6	03	C	32 B1	B 57	11 W 150-103	a = 24; b = 11
32 K 626-306 D3	6	06	C	32 B1	B 57	11 W 150-106	a = 23.5; b = 10.5
32 K 626-307 D3	6	07	C	32 B1	B 57	11 W 150-106	a = 26.5; b = 13.5

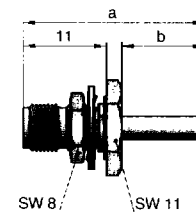

**STRAIGHT JACK, Clamp**

**KUPPLER, klemm**

Part Number	VSWR Class	Cable Group	Assembly Instruction	MIL-Std. C39012	Remarks
32 K 106-002 D3	6	02/03	32 D1		
32 K 106-006 D3	5	06/07	32 D1		

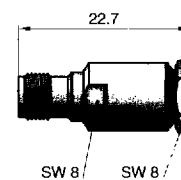

**PANEL AND BULKHEAD CONNECTORS**

**1. SOLDER AND COAXIAL VERSION**

**PANEL PLUG Solder Pot**

**GEHÄUSESTECKER mit Lötstift**

Part Number	VSWR Class	Panel Piercing	Remarks
32 S 401-200 D3	1	B 55	
32 S 421-200 S3	1	B 55	stainless steel

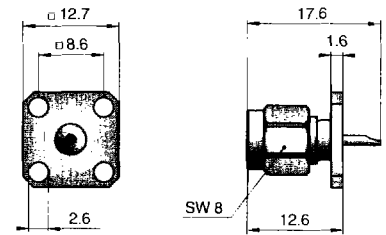

**PANEL PLUG Solder Pot**

**GEHÄUSESTECKER mit Lötstift**

Part Number	VSWR Class	Panel Piercing	Remarks
32 S 701-200 D3	1	B 55	
32 S 721-200 S3	1	B 55	stainless steel

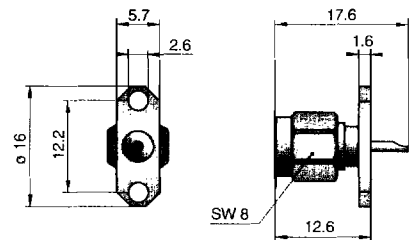

**RIGHT ANGLE PANEL PLUG Solder Pot**

**WINKEL-GEHÄUSESTECKER mit Lötstift**

Part Number	VSWR Class	Panel Piercing	Remarks
32 S 221-200 S3		B 55	stainless steel

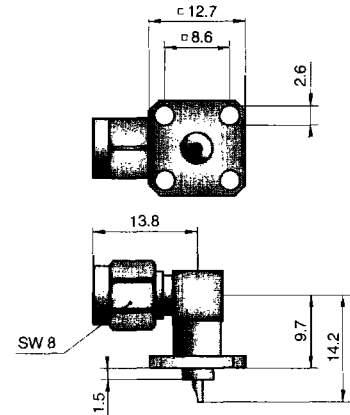

**PANEL PLUG Straight Terminal**

**GEHÄUSESTECKER mit Durchführung**

Part Number	VSWR Class	Panel Piercing	Remarks
32 S 422-500 S3	1	B 55	stainless steel

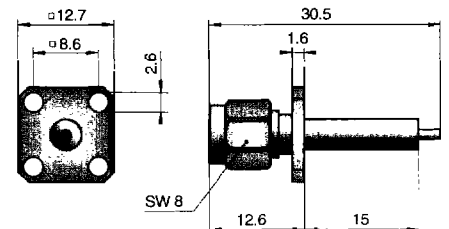

**PANEL PLUG Straight Terminal**

**GEHÄUSESTECKER mit Durchführung**

Part Number	VSWR Class	Panel Piercing	Remarks
32 S 722-500 S3	1	B 55	stainless steel

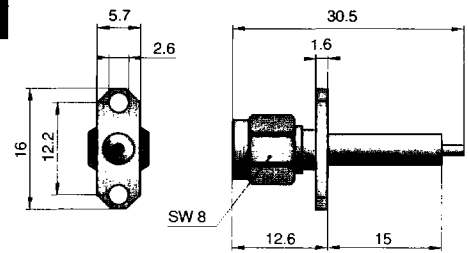

**BULKHEAD JACK Solder Pot**

**GEHÄUSEKUPPLER mit Lötstift**

Part Number	VSWR Class	MIL-Std - C39012	Panel Piercing	Remarks
32 K 521-200 S3	1	/61-3001	B 57	stainless steel, rear mounting

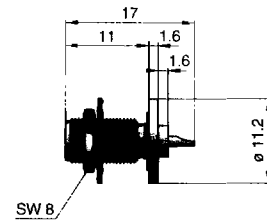

**BULKHEAD JACK Solder Pot**

**GEHÄUSEKUPPLER mit Lötstift**

Part Number	VSWR Class	MIL-Std - C39012	Panel Piercing	Remarks
32 K 622-200 S3	1	/61-3002	B 57	stainless steel, front mounting

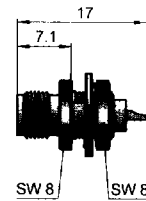

**BULKHEAD JACK Solder Pot**

**GEHÄUSEKUPPLER mit Lötstift**

Part Number	VSWR Class	MIL-Std - C39012	Panel Piercing	Remarks
32 K 603-200 D3	1	/61-4003	B 56	rear mounting
32 K 623-200 S3	1	/61-3003	B56	stainless steel, rear mounting
32 K 643-200 N3			B 56	low cost, rear mounting

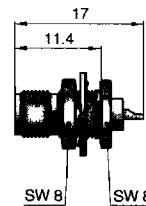

**RIGHT ANGLE FLANGE JACK Solder Pot**    **GEHÄUSE-WINKELKUPPLER mit Lötstift**

Part Number	Panel Piercing	Remarks
32 K 221-200 S3	B 55	stainless steel

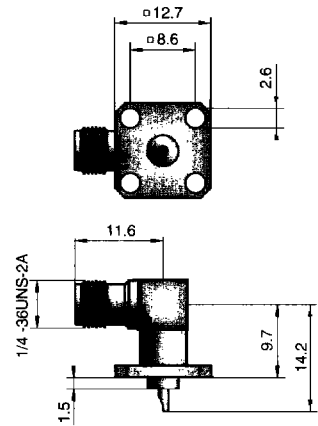

**RIGHT ANGLE BULKHEAD JACK Solder Pot**    **GEHÄUSE-WINKELKUPPLER mit Lötstift**

Part Number	Panel Piercing	Remarks
32 K 222-200 S3	B 56	stainless steel

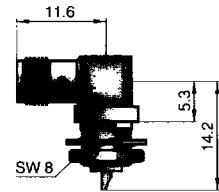

**PANEL JACK Solder Pot**    **GEHÄUSEKUPPLER mit Lötstift**

Part Number	VSWR Class	MIL-Std. C39012	Panel Piercing	Remarks
32 K 401-200 D3	1	/60-4001	B 55	
32 K 421-200 S3	1	/60-3001	B 55	stainless steel
32 K 40A-200 E3			B 55	low cost

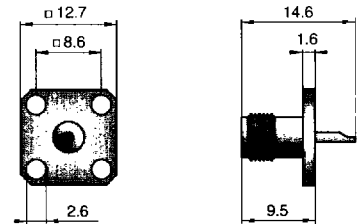

**PANEL JACK Solder Pot**    **GEHÄUSEKUPPLER mit Lötstift**

Part Number	VSWR Class	MIL-Std. C39012	Panel Piercing	Remarks
32 K 701-200 D3	1	/60-4002	B 55	
32 K 721-200 S3	1	/60-3002	B 55	stainless steel
32 K 741-200 N3			B 55	low cost

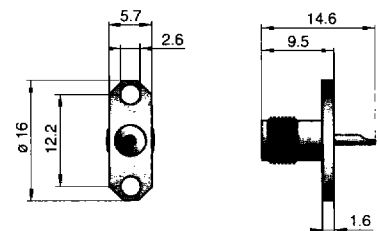

**PANEL JACK Straight Terminal**

**GEHÄUSEDURCHFÜHRUNGS-KUPPLER**

Part Number	VSWR Class	Panel Piercing	Remarks
32 K 421-500 S3	1	B 55	stainless steel

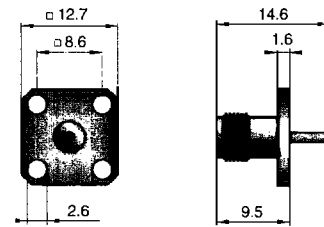

**PANEL JACK Straight Terminal**

**GEHÄUSEDURCHFÜHRUNGS-KUPPLER**

Part Number	VSWR Class	Panel Piercing	Remarks
32 K 402-500 D3	1	B 55	captivated center contact
32 K 422-500 S3	1	B 55	captivated center contact, stainless steel

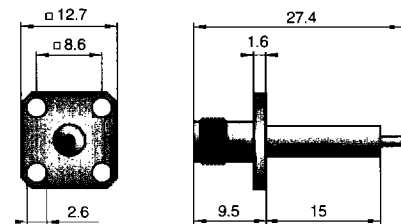

**PANEL JACK Straight Terminal**

**GEHÄUSEDURCHFÜHRUNGS-KUPPLER**

Part Number	VSWR Class	Panel Piercing	Remarks
32 K 702-500 D3	1	B 55	captivated center contact
32 K 722-500 S3	1	B 55	captivated center contact, stainless steel

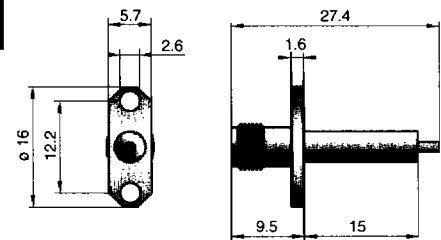

**BULKHEAD JACK Straight Terminal**

**GEHÄUSEDURCHFÜHRUNGS-KUPPLER**

Part Number	VSWR Class	Panel Piercing	Remarks
32 K 121-500 S3	1	1/4-36 UNS-2A	
32 K 141-500 N3		1/4-36 UNS-2A	

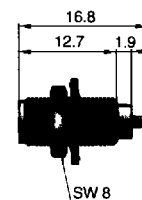

7

**PANEL AND BULKHEAD CONNECTORS**

**1. STRIPLINE AND MICROSTRIP LAUNCHERS**

Transitions SMA to stripline, microstrip etc. have mechanical sizes according to MIL M83517

**PANEL PLUG Stripline**

**GEHÄUSESTECKER, Stripline**

Part Number	VSWR Class	MIL Std	Panel Piercing	Remarks
32 S 421-600 S3	1	M 83517/2	B 55	stainless steel

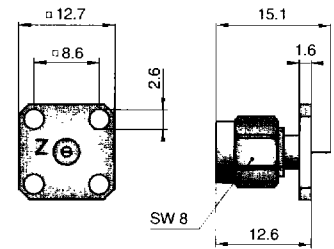

**PANEL PLUG Stripline**

**GEHÄUSESTECKER, Stripline**

Part Number	VSWR Class	MIL Std	Panel Piercing	Remarks
32 S 721-600 S3	1	M 83517/2	B 55	stainless steel

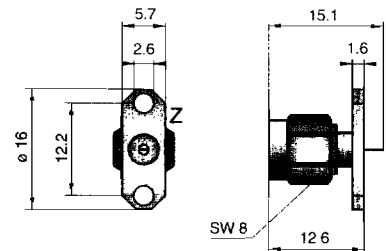

**PANEL PLUG Stripline**

**GEHÄUSESTECKER, Stripline**

Part Number	VSWR Class	MIL Std	Panel Piercing	Remarks
32 S 424-600 S3	1	M 83517/4	B 55	stainless steel

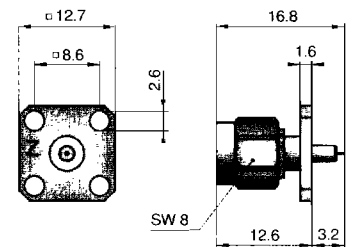

**PANEL PLUG Stripline**

**GEHÄUSESTECKER, Stripline**

Part Number	MIL-Std	Panel Piercing	Remarks
32 S 724-600 S3	M 83517/4	B 55	stainless steel

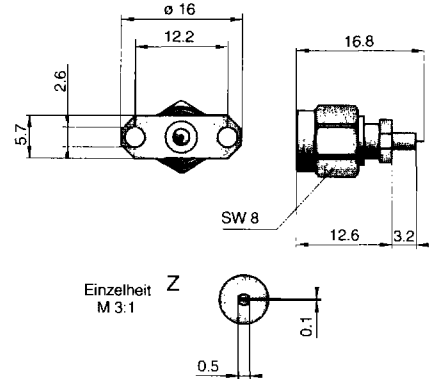

**PANEL JACK, Stripline**

**GEHÄUSEKUPPLER, Stripline**

Part Number	MIL-Std	Panel Piercing	Remarks
32 K 421-600 S3	M 83517/1	B 55	stainless steel
32 K 441-600 N3		B 55	low cost

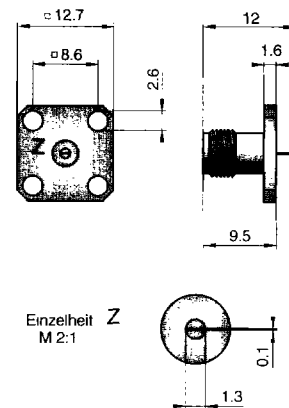

**PANEL JACK, Stripline**

**GEHÄUSEKUPPLER, Stripline**

Part Number	MIL-Std	Panel Piercing	Remarks
32 K 721-600 S3	M 83517/1	B 55	stainless steel

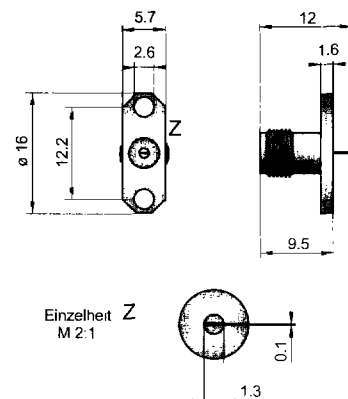

7

**PANEL JACK, Stripline**

**GEHÄUSEKUPPLER, Stripline**

Part Number	VSWR Class	Panel Piercing	Remarks
32 K 424-600 S3	1	B 55	stainless steel

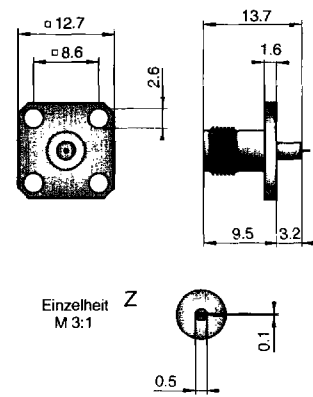

**PANEL JACK, Stripline**

**GEHÄUSEKUPPLER, Stripline**

Part Number	VSWR Class	Panel Piercing	Remarks
32 K 724-600 S3	1	B 55	stainless steel

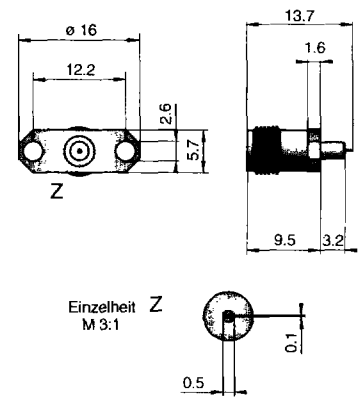

**PANEL PLUG, Microstrip**

**GEHÄUSESTECKER Microstrip**

Part Number	Panel Piercing	Remarks
32 S 421-700 S3	B 55	stainless steel, s = 0.3
32 S 422-700 S3	B 55	stainless steel, s = 0.5
32 S 423-700 S3	B 55	stainless steel, s = 0.7

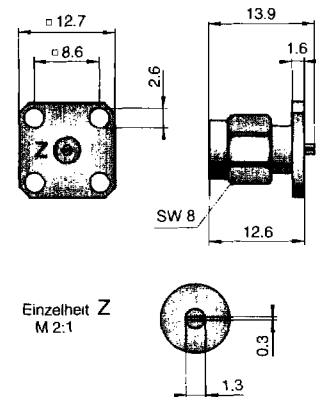

**PANEL JACK, Microstrip**

**GEHÄUSEKUPPLER, Microstrip**

Part Number	Panel Piercing	Remarks
32 K 421-700 S3	B 55	stainless steel, s = 0.3
32 K 422-700 S3	B 55	stainless steel, s = 0.5
32 K 423-700 S3	B 55	stainless steel, s = 0.7

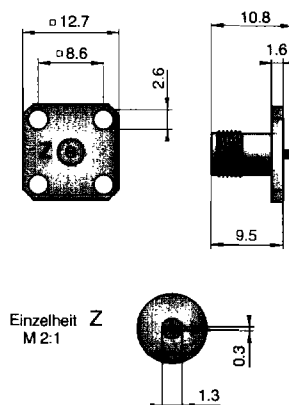

**PANEL PLUG, Stripline and Microstrip GEHÄUSESTECKER, Stripline und Microstrip**

Part Number	MIL-Std	Panel Piercing	Remarks
32 S 422-800 S3	M 83517/11	B 55	stainless steel

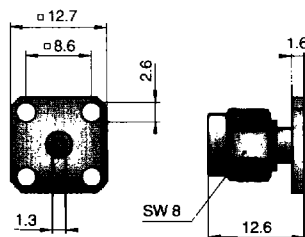

**PANEL PLUG, Stripline and Microstrip GEHÄUSESTECKER, Stripline und Microstrip**

Part Number	Panel Piercing	Remarks
32 S 722-800 S3	B 55	stainless steel

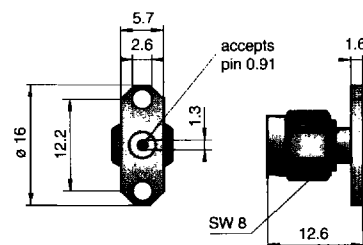

**PANEL JACK, Stripline and Microstrip GEHÄUSEKUPPLER, Stripline und Microstrip**

Part Number	VSWR Class	MIL-Std	Panel Piercing	Remark
32 K 424-800 S3	1	M 83517/10	B 55	stainless steel

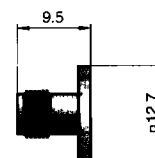

7

**PANEL JACK, Stripline and Microstrip** *GEHÄUSEKUPPLER, Stripline und Microstrip*

Part Number	MIL-Std	Panel Piercing	Remarks
32 K 724-800 S3	M 83517/10	B 55	stainless steel

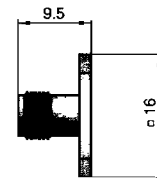

**TRANSITION PINS**

**ÜBERGANGSSTIFTE**

Part Number	VSWR Class	Cat	MIL-Std	Remarks
32 Z 103-600	1	A	/11-33007	fig. A

fig. A

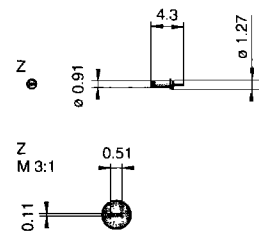

**TRANSITION PINS**

**ÜBERGANGSSTIFTE**

Part Number	VSWR Class	Cat	MIL-Std	Remarks
32 Z 101-700	1	B	/11-33009	fig. B

fig. B

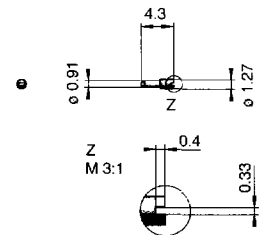

**TRANSITION PINS**

**ÜBERGANGSSTIFTE**

Part Number	VSWR Class	Cat	MIL-Std	Remarks
32 Z 101-500	1	C	/11-33012	fig. C

fig. C

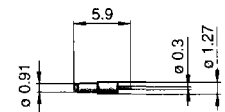

**TRANSITION PINS**

**ÜBERGANGSSTIFTE**

Part Number	VSWR Class	Cat	MIL-Std	Remarks
32 Z 106-500	1	D	/11-33014	fig. D

fig. D

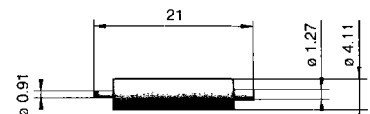

**END LAUNCH JACK STRIPLINE Direct Mount**

Part Number	VSWR Class	MIL-Std. M 83517/9	Remarks
32 K 901-600 D3	1	-31001	a = 1.5, b = 0.64
32 K 902-600 D3	1	-31002	a = 3.1, b = 1.27
32 K 903-600 D3	1	-31003	a = 6.3, b = 1.27

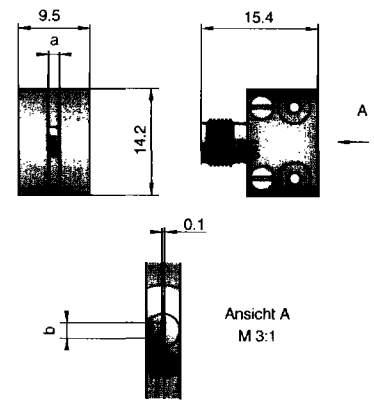

**PANEL AND BULKHEAD CONNECTORS**

**3. HERMETIC SEALED CONNECTOR**

Rosenberger SMA hermetic are sealed with a glass feedthru matched to 50 Ω. Leakage rate < 10<sup>-8</sup> cc/sec. Pressure max. 2 N/mm<sup>2</sup>

**BULKHEAD JACK, Spark Plug**

**GEHÄUSEDURCHFÜHRUNG, Spark Plug**

Part Number	Panel Piercing	Remarks
32 K 101-5H0 D3	1/4-36 UNS-2A	

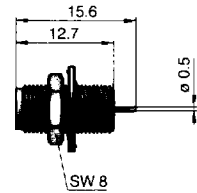

**BULKHEAD JACK, Solder Mount**

**GEHÄUSEDURCHFÜHRUNG zum Einlöten**

Part Number	O	Remarks
32 K 102-5H0 D3	5.2	a = 2.4
32 K 103-5H0 D3	5.2	a = 3.2
32 K 104-5H0 D3	5.2	a = 4.8

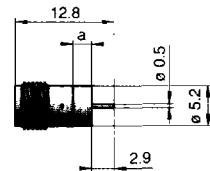

**BULKHEAD JACK ADAPTOR**

**GEHÄUSEVERBINDER**

Part Number	VSWR Class	Remarks
32 K 101 -KH0 D3	DC - 18 GHz VSWR max. 1.3	panel thickness max. 4.8 mm

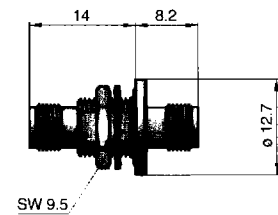

**BULKHEAD PLUG, Panel Solder Mount**

**GEHÄUSEDURCHFÜHRUNG zum Einlöten**

Part Number	Remarks
32 S 102-5H0 D3	a = 2.4
32 S 103-5H0 D3	a = 3.2
32 S 104-5H0 D3	a = 4.8

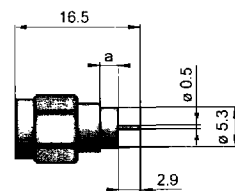

CONNECTORS FOR PC-BOARDS

STRAIGHT JACK

KUPPLER gerade

Part Number	MIL Std	Panel Piercing	Remarks
32 K 101-400 D3	/93-4001	B 30	
32 K 10A-400 E3		B 30	low cost

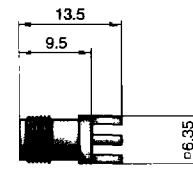

STRAIGHT PRESS-FIT JACK

PRESS-FIT KUPPLER gerade

Part Number	Panel Piercing	Remarks
32 K 101-40P D3	B 79	

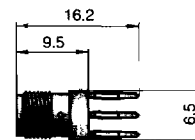

RIGHT ANGLE JACK

WINKELKUPPLER

Part Number	MIL Std	Panel Piercing	Remarks
32 K 201-400 D3	/94-4001	B 30	
32 K 241-400 N3		B 30	low cost

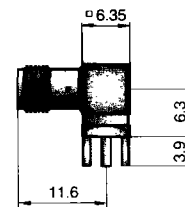

RIGHT ANGLE JACK

WINKELKUPPLER

Part Number	Panel Piercing	Remarks
32 K 246-400 D3	B 30	

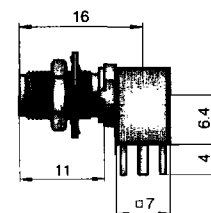

**ADAPTORS**

**STRAIGHT ADAPTOR**

**VERBINDER gerade**

Part Number	VSWR Class	Remarks
32 K 101-K00 D3	1	
32 K 121-K00 S3	1	stainless steel

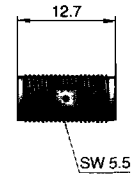

**STRAIGHT ADAPTOR**

**VERBINDER gerade**

Part Number	VSWR Class	Remarks
32 S 103-S00 D3	1	
32 S 123-S00 S3	1	stainless steel

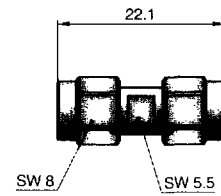

**STRAIGHT ADAPTOR**

**VERBINDER gerade**

Part Number	VSWR Class	Remarks
32 S 105-K00 D3	1	
32 S 125-K00 S3	1	stainless steel

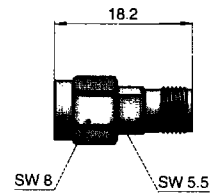

**RIGHT ANGLE ADAPTOR**

**WINKELVERBINDER**

Part Number	VSWR Class	Remarks
32 S 201-K00 D3	DC - 6 GHz VSWR max. 1.25	
32 S 221-K00 S3	DC - 6 GHz VSWR max. 1.25	stainless steel

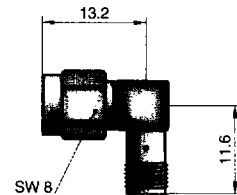

**RIGHT ANGLE ADAPTOR**

**WINKELVERBINDER**

Part Number	VSWR Class	Remarks
32 K 201-K00 D3	DC - 6 GHz VSWR max. 1.25	
32 K 221-K00 S3	DC - 6 GHz VSWR max. 1.25	stainless steel

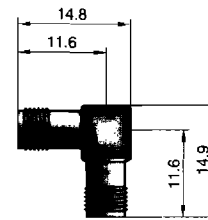

**T-ADAPTOR**

**T-VERBINDER**

Part Number	VSWR Class	Remarks
32 S 301-K00 D3	DC - 6 GHz VSWR max. 1.25	
32 S 321-K00 S3	DC - 6 GHz VSWR max. 1.25	stainless steel

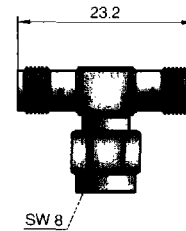

**T-ADAPTOR**

**T-VERBINDER**

Part Number	VSWR Class	Remarks
32 K 301-K00 D3	DC - 6 GHz VSWR max. 1.25	
32 K 321-K00 S3	DC - 6 GHz VSWR max. 1.25	stainless steel

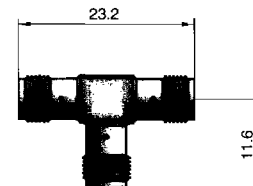

**BULKHEAD ADAPTOR**

**GEHÄUSEVERBINDER**

Part Number	VSWR Class	Remarks
32 K 601-K00 D3	DC - 6 GHz VSWR max. 1.25	panel thickness max. 6.4 mm
32 K 621-K00 S3	DC - 6 GHz VSWR max. 1.25	panel thickness max. 6.4 mm, stainless steel

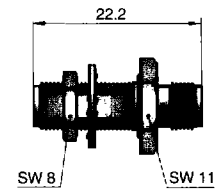

7

**ACCESSORIES**

**TERMINATION, PLUG**

**ABSCHLUSSWIDERSTAND, STECKER**

Part Number	VSWR Class	Remarks
32 S 150-010 S3	2	18 GHz
32 S 15R-0.5 D3		4 GHz, economic

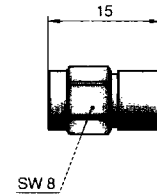

**TERMINATION, JACK**

**ABSCHLUSSWIDERSTAND, KUPPLER**

Part Number	VSWR Class	Remarks
32 K 150-010 S3	2	18 GHz
32 K 15R-0.5 D3		4 GHz, economic

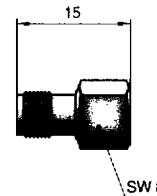

**PROTECTION CAP with Chain**

**SCHUTZKAPPE mit Kette**

Part Number	VSWR Class	Remarks
32 Z 112-000 D		with seal

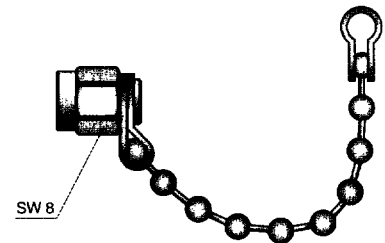

**SHORT**

**KURZSCHLUSS**

Part Number	VSWR Class	Remark
32 Z 111-000 D3		plug
32 Z 114-000 D3		jack

