

OPIA401 through OPIA409, OPIA414 SMD, SOP and SSOP Packages

Features:

- 2,500 or 3,750 Vrms electrical isolation
- Choice of a Single and Dual LED
- Phototransistor or Photo Darlington Sensor
- Low-cost plastic Dual-In-Line (DIP) package

Agency Approvals:

- UL Certification No: E58730
- VDE No: 40026577(OPIA401-404), 40026553(OPIA405-409)

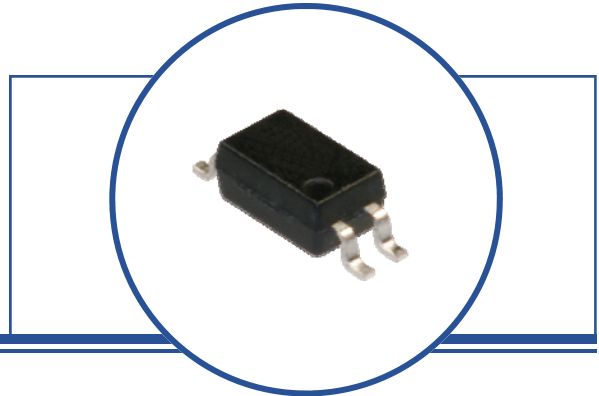

Description:

The OPIA series optocouplers are designed for applications that use an analog output (Phototransistor or Photodarlington) in a surface mount package. A wide selection of configurations are available. With typical isolation voltage of 2,500 or 3,750 Volts(RMS), these products meet typical power system isolation requirements.

Theory of operation: The LED transmitter is used to illuminate the Photo sensor providing electrical isolation between two power systems while maintaining the ability to transmit information from one power system to the other. In many applications, analog signal levels may be required to be transmitted between two power systems while maintaining isolation between the power systems up to 3,750 Volts(RMS). A variety of LED and photo sensor configurations are available depending on the system requirements.

The Current Transfer Ratio (CTR) is determined using the output current and input current for analog photo sensors. CTR ratios can range from as low as 5 to over 9,000 depending on the device.

$$CTR = \frac{\text{Photosensor - Current}}{\text{LED - Current}} = \frac{20mA}{10mA} * 100 = 200$$

All SMD products are shipped in a shipping tube with "TR" identified on the end of the part number.

Example: OPI401ATRE is a 4-Pin SMD shipped in tape and reel (TR)

Applications:

- High voltage isolation: 2,500 or 3,750 Volts(RMS)
- PCBoard power system isolation
- Industrial equipment power isolation
- Medical equipment power isolation
- Office equipment



RoHS

OPTEK reserves the right to make changes at any time in order to improve design and to supply the best product possible.

OPIA401 through OPIA409, OPIA414 SMD, SOP and SSOP Packages



Package Outline Dimensions and Schematics: Top-View

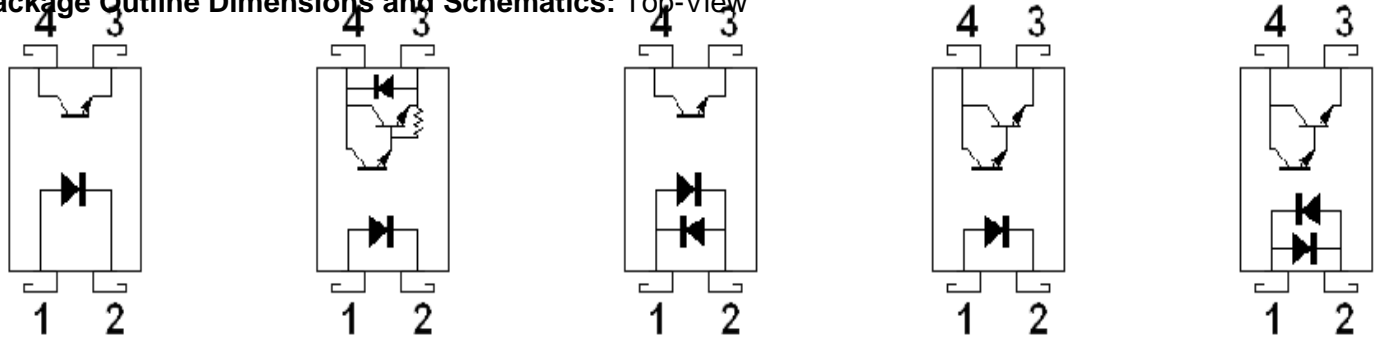

OPIA404
OPIA405
OPIA414

OPIA401
OPIA409

OPIA402
OPIA407

OPIA403
OPIA406

OPIA408

Package Style C
(SSOP)

Package Style B
(SOP)

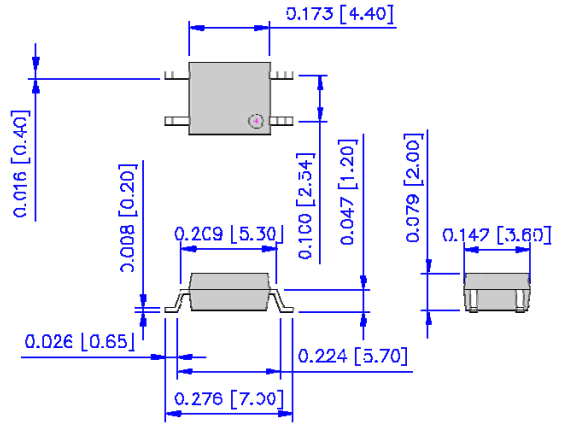
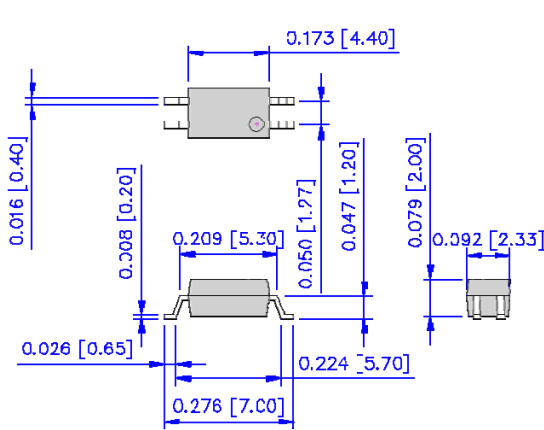

Part Number	Pin #			
	1	2	3	4
OPIA401B	A	K	E	C
OPIA402B	A-K	K-A	E	C
OPIA403B	A	K	E	C
OPIA404B	A	K	E	C
OPIA405C	A		E	C
OPIA406C	A	K	E	C
OPIA407C	A-K	K-A	E	C
OPIA408C	A	K	E	C
OPIA409C	A	K	E	C
OPIA414B	A	K	E	C

Package Style A
(SMD)

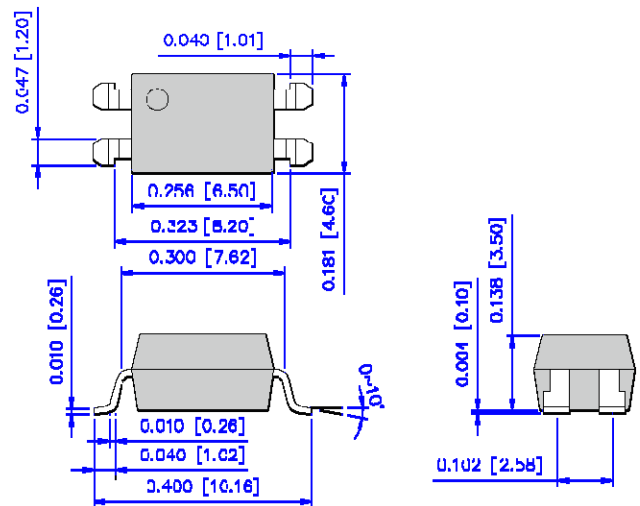

OPTEK reserves the right to make changes at any time in order to improve design and to supply the best product possible.

OPIA401 through OPIA409, OPIA414 SMD, SOP and SSOP Packages



Analog Output Devices Ordering Information

Part Number	Isolation Voltage Max. (Vrms)	CTR Min/Typ/Max	Typ. Tr / Tf (µs) R _L = 100 ohms	Package	Configuration
OPIA401B	3,750	1,000 / - / -	100 / 20	4-Pin SOP	A K—C E (Dar)
OPIA402B	3,750	20 / - 400	4 / 3	4-Pin SOP	A K, K A—C E
OPIA403B	3,750	600 / 1,600 / 7,500	60 / 53	4-Pin SOP	A K—C E (Dar)
OPIA404B	3,750	50 / - / 600	5 / 4	4-Pin SOP	A K—C E
OPIA405CxxA	2,500	80 / - / 160	3 / 5	4-Pin SSOP	A K—C E
OPIA405CxxB	2,500	130 / - / 260	3 / 5	4-Pin SSOP	A K—C E
OPIA405CxxC	2,500	200 / - / 400	3 / 5	4-Pin SSOP	A K—C E
OPIA405CxxD	2,500	300 / - / 600	3 / 5	4-Pin SSOP	A K—C E
OPIA405CxxE	2,500	50 / - / 600	3 / 5	4-Pin SSOP	AK—CE
OPIA406C	2,500	200 / 2,000 / -	200 / 200	4-Pin SSOP	A K—C E (Dar)
OPIA407C	2,500	80 / - / 600	3 / 5	4-Pin SSOP	A K, K A—C E
OPIA408C	2,500	200 / 2,000 / -	200 / 200	4-Pin SSOP	A K—C E (Dar)
OPIA409C	2,500	400 / 2,000 -	40 / 10	4-Pin SSOP	A K—C E (Dar)
OPIA414B	3,750	100 / - / 600	4 / 3	4-Pin SOP	A K—C E
Configuration: Definition of Terms LED Identification—Sensor Identification					
Configuration Information	LED	A = Anode	K = Cathode		
	Sensor	B = Base	C = Collector	E = Emitter	(Dar) = Photodarlington
Packaging	Part Number Suffix: TU = Shipped in Tubes TR = Tape & Reel				Example: OPIA405CTUE

OPTEK reserves the right to make changes at any time in order to improve design and to supply the best product possible.

OPIA401 through OPIA409, OPIA414

SMD, SOP and SSOP Packages



Absolute Maximum Ratings ($T_A = 25^\circ\text{C}$ unless otherwise noted)

Storage Temperature OPIA404, OPIA414 OPIA401, OPIA402, OPIA403 OPIA405, OPIA406, OPIA407, OPIA408, OPIA409	-55° C to +125° C -40°C to +125° C -55°C to +150° C
Operating Temperature All except the part numbers noted below OPIA404 OPIA414	-30° C to +100° C -55° C to +115° C -30° C to +115° C
Isolation voltage (1 minute) OPIA400 OPIA401, OPIA402, OPIA403, OPIA404, OPIA414 OPIA405, OPIA406, OPIA407, OPIA408, OPIA409	5,000 Vrms 3,750 Vrms 2,500 Vrms
Total Package Power Dissipation OPIA401, OPIA402, OPIA403, OPIA404, OPIA414 OPIA405 OPIA406, OPIA407, OPIA408, OPIA409	170 mW 160 mW -
Lead Soldering Temperature (1/16" (1.6 mm) from case for 5 seconds with soldering iron)	260° C

Input Diode

Continuous Forward Current All except the part number noted below OPIA414	50 mA 10 mA
Peak Forward current (1 μs pulse width, 300 pps) All except the part number noted below OPIA414	1 A 200 mA
Reverse Voltage OPIA401, OPIA403, OPIA404, OPIA405, OPIA406, OPIA409, OPIA414 OPIA402, OPIA407, OPIA408, OPIA409, OPIA410, OPIA412	6 V -
Power Dissipation OPIA401, OPIA402, OPIA403, OPIA404 OPIA405, OPIA406, OPIA407, OPIA408, OPIA409 OPIA414	70 mW 60 mW 15 mW

Output Phototransistor

Collector-Emitter Voltage OPIA402, OPIA404 OPIA401, OPIA409 OPIA403 OPIA406, OPIA408 OPIA405, OPIA407, OPIA414	60 V 300 V 35 V 40 V 80 V
Emitter-Collector Voltage OPIA405, OPIA406, OPIA407, OPIA408 OPIA401 OPIA402, OPIA403, OPIA404 OPIA409 OPIA414	6 V 0.1 V 5 V 0.3 V 7 V
Collector Current OPIA402, OPIA404, OPIA405, OPIA407, OPIA414 OPIA401, OPIA403 OPIA406, OPIA408 OPIA409	50 mA 150 mA 90 mA 60 mA
Power Dissipation All except the part numbers noted below OPIA405, OPIA406, OPIA407, OPIA408, OPI409	150 mW 120 mW

OPTEK reserves the right to make changes at any time in order to improve design and to supply the best product possible.

OPIA401 through OPIA409, OPIA414 SMD, SOP and SSOP Packages



Electrical Characteristics

SYMBOL	PARAMETER	MIN	TYP	MAX	UNITS	TEST CONDITIONS
--------	-----------	-----	-----	-----	-------	-----------------

Input Diode

V_F	Forward Voltage All except those noted below OPIA404 OPIA405, OPIA406, OPIA407, OPIA408 OPIA401, OPIA409, OPIA414	- - - -	1.2 1.6 1.1 1.2	1.4 1.75 1.4 1.4	V	$I_F = 20\text{ mA}$ $I_F = 10\text{ mA}$ $I_F = 5\text{ mA}$ $I_F = 10\text{ mA}$ I
V_{FM}	Peak Forward Voltage OPIA403 OPIA405 OPIA401, OPIA404, OPIA414, OPIA406, OPIA407, OPIA408, OPIA409	- - -	- - -	3.5 3.0 -	V	$I_{FM} = 500\text{ mA}$
I_R	Reverse Current All except those noted below OPIA404, OPIA407, OPIA408, OPIA414 OPIA405, OPIA406, OPIA409	- - -	- - -	10 - 5	μA	$V_R = 4\text{ V}$ - $V_R = 5\text{ V}$
C_t	Terminal Capacitance All except those noted below OPIA402, OPIA404, OPIA414 OPIA408, OPIA409	- - -	30 30 60	- 250 -	pf	$V = 0.0\text{ V}, f = 1\text{K Hz}$ $V = 0.0\text{ V}, f = 1\text{K Hz}$ $V = 0.0\text{ V}, f = 1\text{M Hz}$

Output Phototransistor

I_{CEO}	Collector dark Current OPIA400, OPIA402, OPIA404 OPIA405, OPIA407 OPIA414	- - -	- - -	100 100 100	nA	$I_F = 0\text{ mA}, V_{CE} = 20\text{ V}$ $I_F = 0\text{ mA}, V_{CE} = 80\text{ V}$ $I_F = 0\text{ mA}, V_{CE} = 50\text{ V}$
$V_{CE(SAT)}$	Collector-emitter Saturation Voltage OPIA405, OPIA407 OPIA402, OPIA404, OPIA410 OPIA414	- - -	0.1 0.1 0.1	0.3 0.3 0.2	V	$I_F = 10\text{ mA}, I_C = 2\text{ mA}$ $I_F = 20\text{ mA}, I_C = 1\text{ mA}$ $I_F = 10\text{ mA}, I_C = 1\text{ mA}$
f_c	Cutt-Off frequency All except those noted below	-	-	-	K Hz	$V_{CC} = 5\text{ V}, I_C = 2\text{ mA}, R_L = 100\ \Omega$
t_R	Rise Time OPIA402, OPIA414 OPIA405, OPIA407 OPIA404	- - -	4 3 5	18 18 20	μs	$V_{CC} = 2\text{ V}, I_C = 2\text{ mA}, R_L = 100\ \Omega$ $V_{CC} = 5\text{ V}, I_C = 2\text{ mA}, R_L = 100\ \Omega$ $V_{CC} = 2\text{ V}, I_C = 2\text{ mA}, R_L = 100\ \Omega$
t_F	Fall Time OPIA402, OPIA414 OPIA405, OPIA407 OPIA404	- - -	3 5 4	18 18 20	μs	$V_{CC} = 2\text{ V}, I_C = 2\text{ mA}, R_L = 100\ \Omega$ $V_{CC} = 5\text{ V}, I_C = 2\text{ mA}, R_L = 100\ \Omega$ $V_{CC} = 2\text{ V}, I_C = 2\text{ mA}, R_L = 100\ \Omega$

Continued on Next Page

OPTEK reserves the right to make changes at any time in order to improve design and to supply the best product possible.

OPIA401 through OPIA409, OPIA414

SMD, SOP and SSOP Packages



Electrical Characteristics (OPIA400 Series) - Continued from Previous Page

SYMBOL	PARAMETER	MIN	TYP	MAX	UNITS	TEST CONDITIONS
Output PhotoDarlington						
I_{CEO}	Collector dark Current OPIA401 OPIA403 OPIA406, OPIA408 OPIA409	- - - -	- - - -	1.0 1.0 0.4 0.4	μ A	$I_F = 0$ mA, $V_{CE} = 200$ V $I_F = 0$ mA, $V_{CE} = 10$ V $I_F = 0$ mA, $V_{CE} = 40$ V $I_F = 0$ mA, $V_{CE} = 300$ V
$V_{CE(SAT)}$	Collector-emitter Saturation Voltage OPIA403 OPIA406, OPIA408, OPIA409 OPIA401	- - -	- - 0.8	1.0 1.0 1.5	V	$I_F = 20$ mA, $I_C = 1$ mA $I_F = 1$ mA, $I_C = 2$ mA $I_F = 20$ mA, $I_C = 100$ mA
f_c	Cut-Off frequency OPIA401, OPIA406, OPIA408, OPIA409 OPIA403	- 1.0	- 7.0	- -	K Hz	- $V_{CC} = 5$ V, $I_C = 2$ mA, $R_L = 100$ Ω
t_r	Rise Time OPIA401 OPIA403 OPIA406, OPIA408 OPIA409	- - - -	100 60 200 40	300 300 - -	μ s	$V_{CC} = 2$ V, $I_C = 20$ mA, $R_L = 100$ Ω $V_{CC} = 2$ V, $I_C = 2$ mA, $R_L = 100$ Ω $V_{CC} = 5$ V, $I_C = 2$ mA, $R_L = 100$ Ω $V_{CC} = 5$ V, $I_C = 10$ mA, $R_L = 100$ Ω
t_f	Fall Time OPIA401 OPIA403 OPIA406, OPIA408 OPIA409	- - - -	20 53 200 10	100 250 - -	μ s	$V_{CC} = 2$ V, $I_C = 20$ mA, $R_L = 100$ Ω $V_{CC} = 2$ V, $I_C = 2$ mA, $R_L = 100$ Ω $V_{CC} = 5$ V, $I_C = 2$ mA, $R_L = 100$ Ω $V_{CC} = 5$ V, $I_C = 10$ mA, $R_L = 100$ Ω

Coupled Characteristics

CTR	Current Transfer Ratio OPIA404 OPIA401 OPIA402 OPIA403 OPIA405(See Table, page 3) OPIA406, OPIA408 OPIA407 OPIA409 OPIA414	50 1,000 20 600 50 20 0.3 400 100	- - - - - 2,000 1.0 2,000 -	600 - 400 7,500 600 - 3.0 - 600	%	$I_F = 5.00$ mA, $V_{CE} = 5.0$ V $I_F = 1.00$ mA, $V_{CE} = 2.0$ V $I_F = 1.00$ mA, $V_{CE} = 5.0$ V $I_F = 1.00$ mA, $V_{CE} = 2.0$ V $I_F = 5.00$ mA, $V_{CE} = 5.0$ V $I_F = 1.00$ mA, $V_{CE} = 2.0$ V $I_F = 5.00$ mA, $V_{CE} = 5.0$ V $I_F = 1.00$ mA, $V_{CE} = 2.0$ V $I_F = 1.00$ mA, $V_{CE} = 5.0$ V
C_f	Floating Capacitance OPIA405, OPIA406, OPIA407, OPIA408, OPIA409	- -	0.6 0.4	1.0 -	pF	$V = 0.0$ V, $f = 1$ M Hz
R_{ISO}	Isolation resistance	5×10^{10}	10^{11}	-	ohm	C500V, 40% to 60%RH

OPTEK reserves the right to make changes at any time in order to improve design and to supply the best product possible.

OPIA401

Fig.1 Forward Current vs. Ambient Temperature

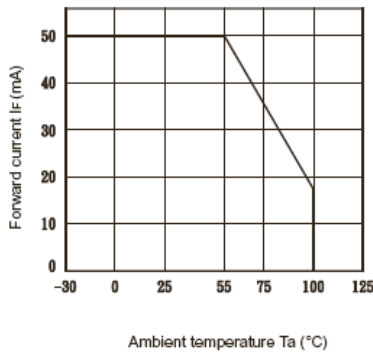

Fig.2 Collector Power Dissipation vs. Ambient Temperature

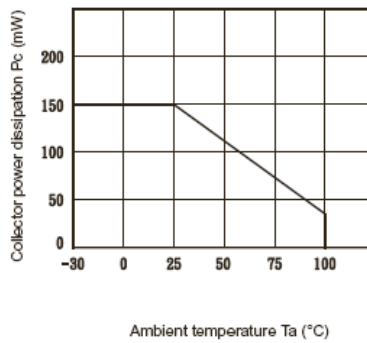

Fig.3 Peak Forward Current vs. Duty Ratio

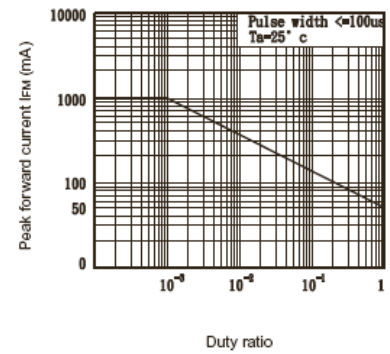

Fig.4 Forward Current vs. Forward Voltage

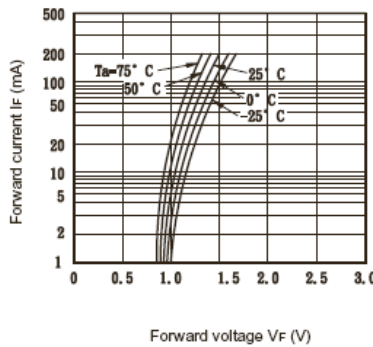

Fig.5 Current Transfer Ratio vs. Forward Current

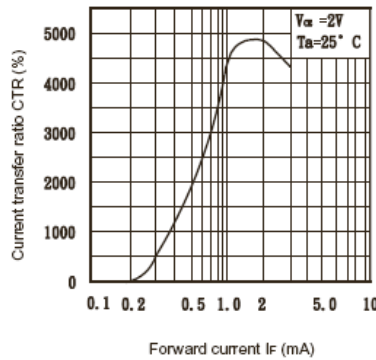

Fig.6 Collector Current vs. Collector-emitter Voltage

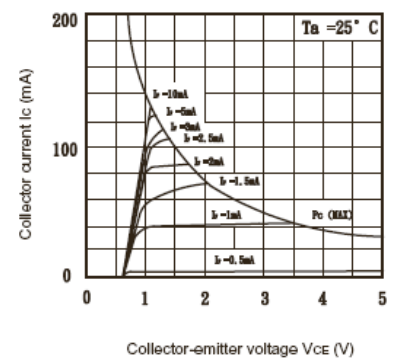

Fig.7 Relative Current Transfer Ratio vs. Ambient Temperature

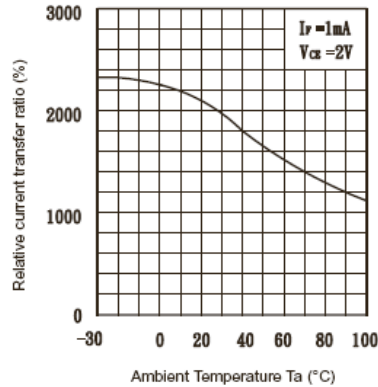

Fig.8 Collector-emitter Saturation Voltage vs. Ambient Temperature

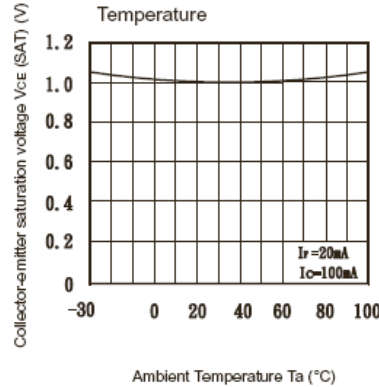
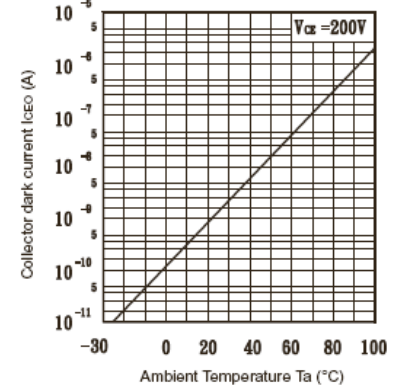

Fig.9 Collector Dark Current vs. Ambient Temperature



OPTeK reserves the right to make changes at any time in order to improve design and to supply the best product possible.

OPIA401

Fig.10 Response Time vs. Load Resistance

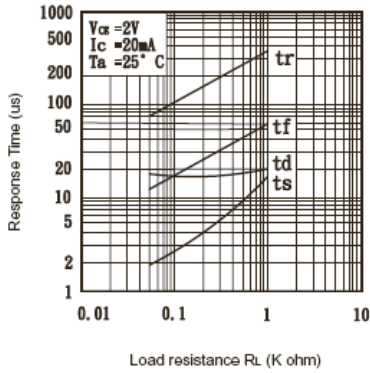

Fig.11 Frequency Response

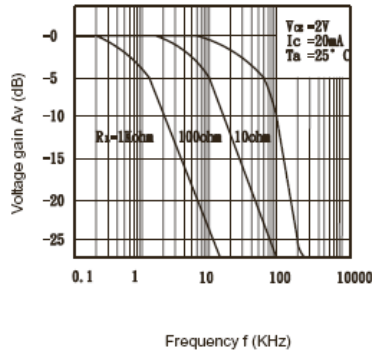
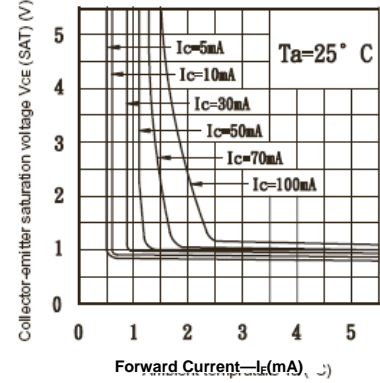

Fig.12 Collector-emitter Saturation Voltage vs. Forward current



OPTEK reserves the right to make changes at any time in order to improve design and to supply the best product possible.

OPIA402

Fig.1 Forward Current vs. Ambient Temperature

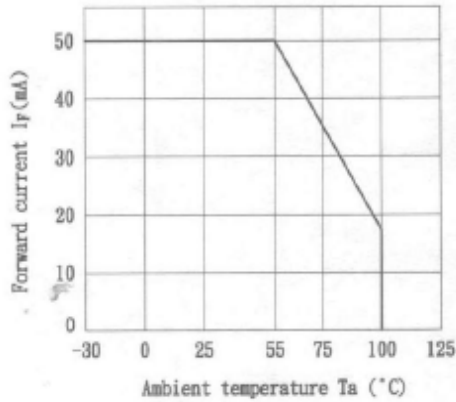

Fig.2 Diode Power Dissipation vs. Ambient Temperature

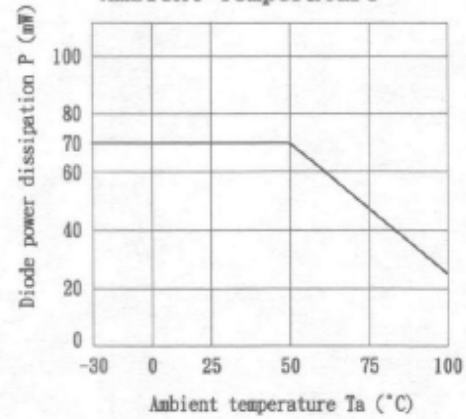

Fig.3 Collector Power Dissipation vs. Ambient Temperature

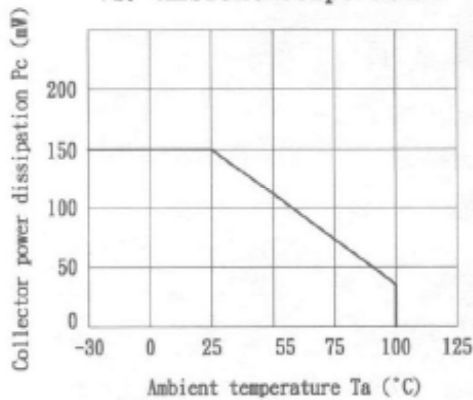

Fig.4 Total Power Dissipation vs. Ambient Temperature

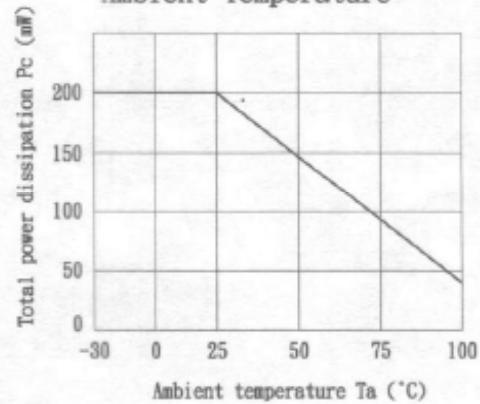

Fig.5 Peak Forward Current vs. Duty Ratio

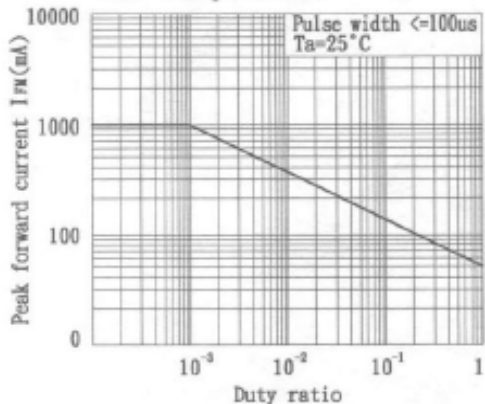
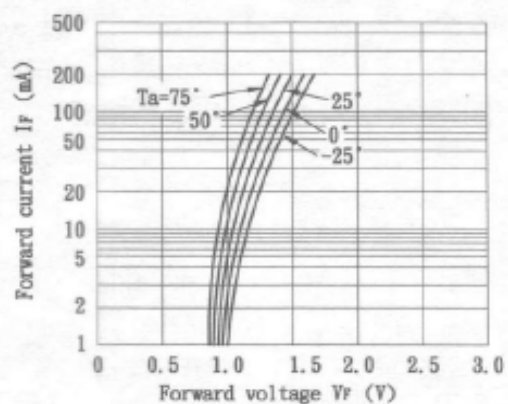

Fig.6 Forward Current vs. Forward Voltage



OPTEK reserves the right to make changes at any time in order to improve design and to supply the best product possible.

OPIA402

Fig. 7 Current Transfer Ratio vs. Forward Current

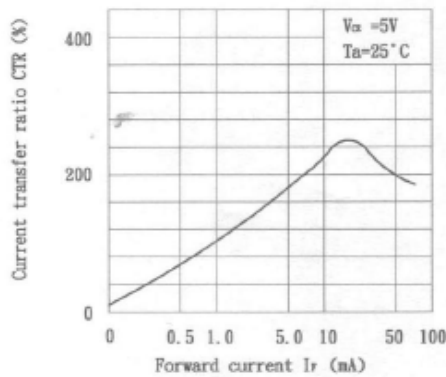

Fig. 8 Collector Current vs. Collector-emitter Voltage

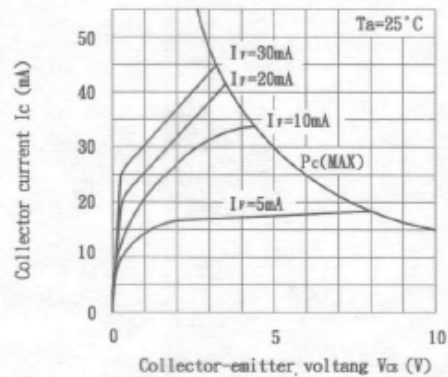

Fig. 9 Relative Current Transfer Ratio vs. Ambient Temperature

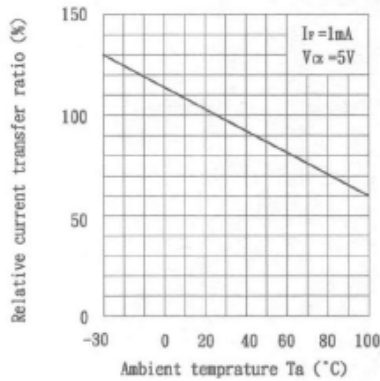

Fig. 10 Collector-emitter Saturation Voltage vs. Ambient Temperature

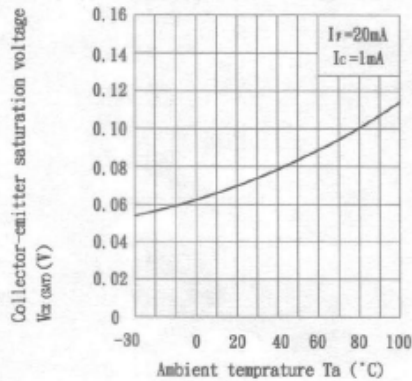

Fig. 11 Collector Dark Current vs. Ambient Temperature

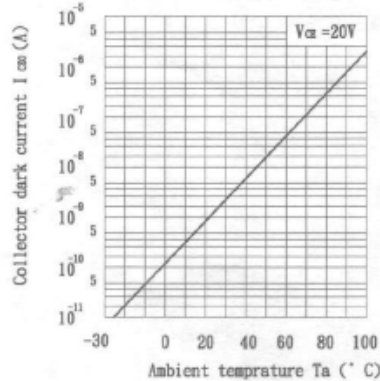
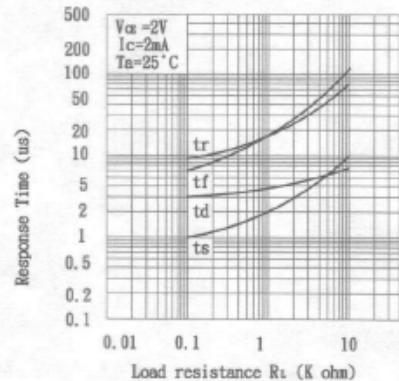

Fig. 12 Response Time vs. Load Resistance



OPTEK reserves the right to make changes at any time in order to improve design and to supply the best product possible.

OPIA403

Fig.1 Forward Current vs. Ambient Temperature

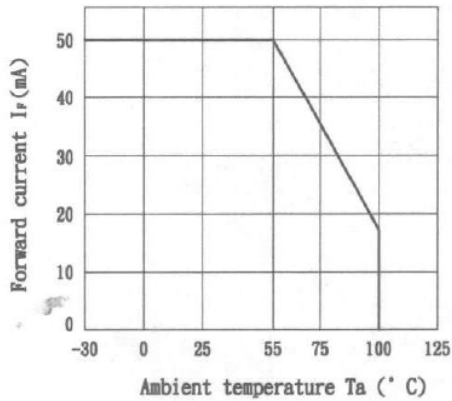

Fig.2 Collector Power Dissipation vs. Ambient Temperature

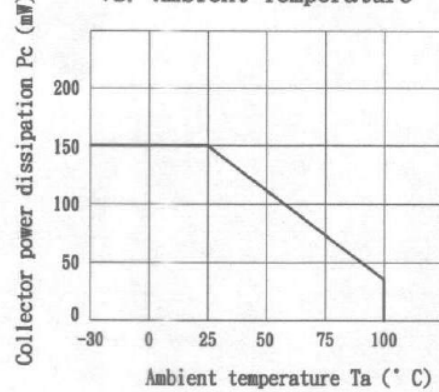

Fig.3 Peak Forward Current vs. Duty Ratio

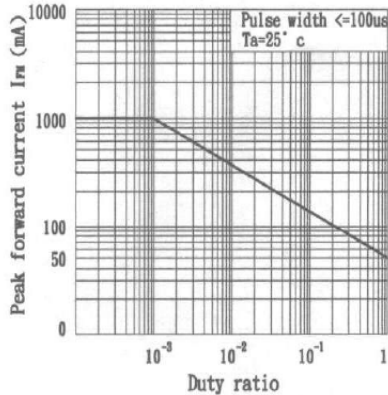

Fig.4 Forward Current vs. Forward Voltage

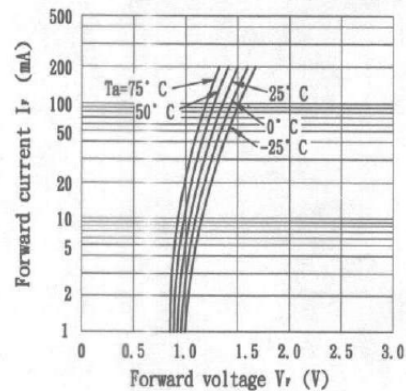

Fig.5 Current Transfer Ratio vs. Forward Current

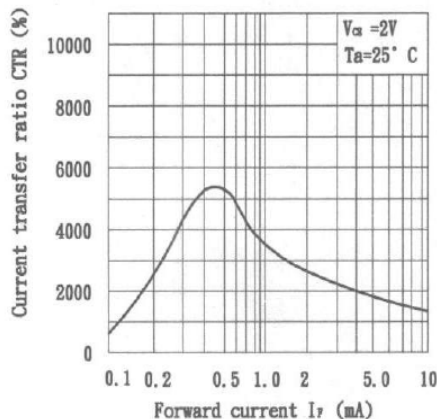
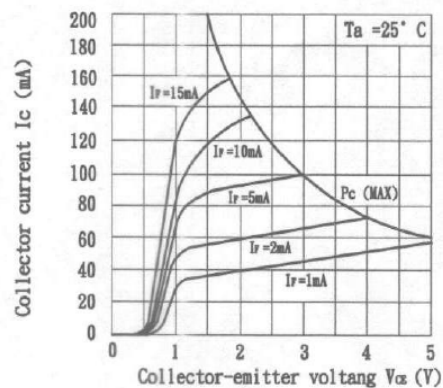

Fig.6 Collector Current vs. Collector-emitter Voltage



OPTEK reserves the right to make changes at any time in order to improve design and to supply the best product possible.

OPIA403

Fig.7 Relative Current Transfer Ratio vs. Ambient Temperature

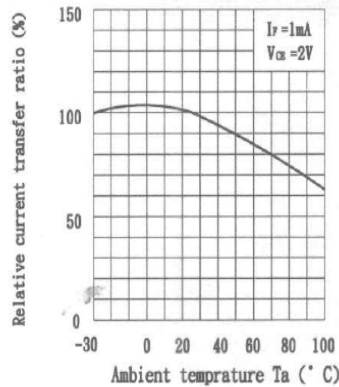

Fig.8 Collector-emitter Saturation Voltage vs. Ambient Temperature

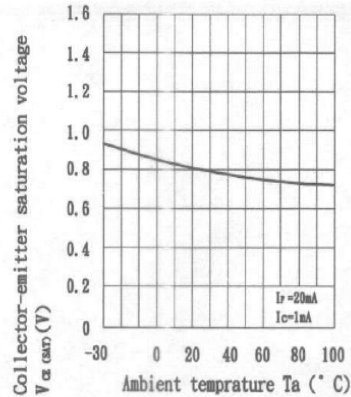

Fig.9 Collector Dark Current vs. Ambient Temperature

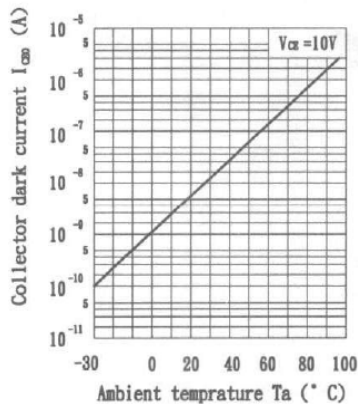

Fig.10 Response Time vs. Load Resistance

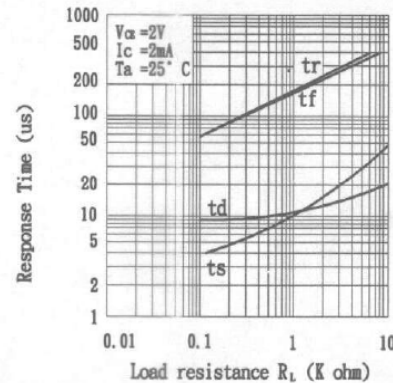
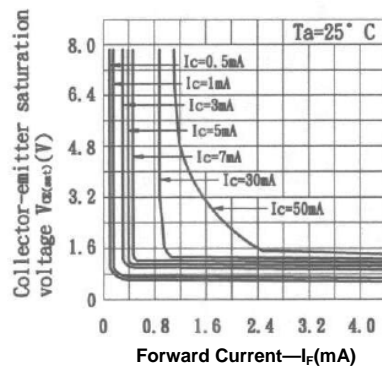

Fig.11 Collector-emitter Saturation Voltage vs. Forward Current



OPTEK reserves the right to make changes at any time in order to improve design and to supply the best product possible.

OPIA404

Fig.1 Forward Current vs. Ambient Temperature

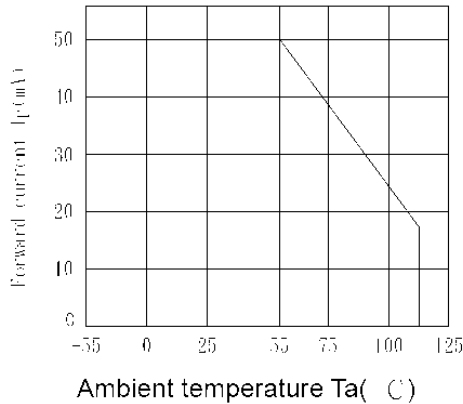

Fig.2 Diode Power Dissipation vs. Ambient Temperature

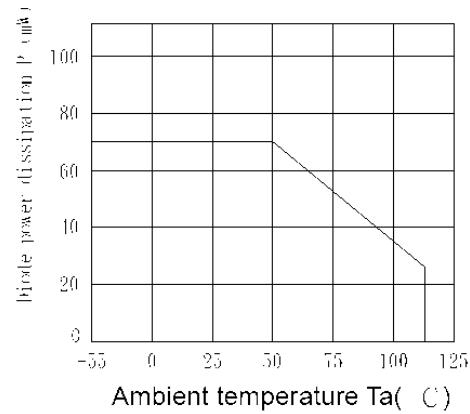

Fig.3 Collector Power Dissipation vs. Ambient Temperature

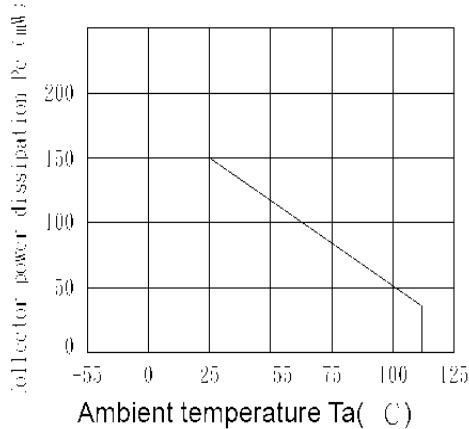

Fig.4 Total Power Dissipation vs. Ambient Temperature

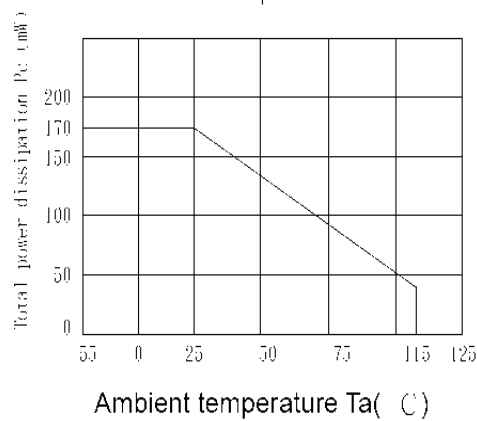

Fig.5 Peak Forward Current vs. Duty Ratio

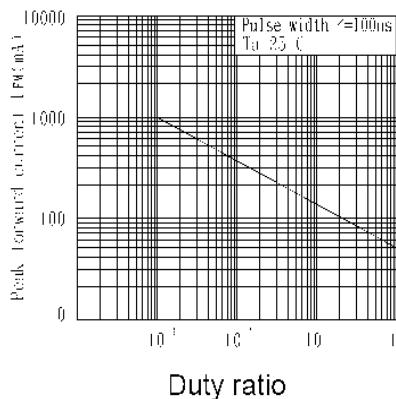
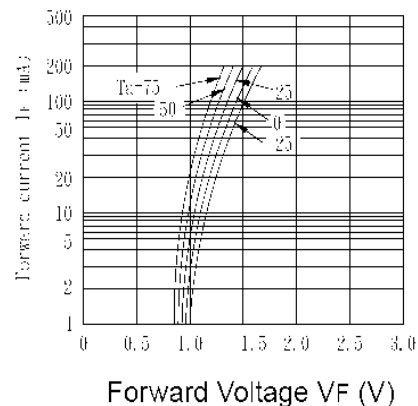

Fig.6 Forward Current vs. Forward Voltage



OPTEK reserves the right to make changes at any time in order to improve design and to supply the best product possible.

OPIA404

Fig.9 Collector Current vs. Collector-Emitter Voltage

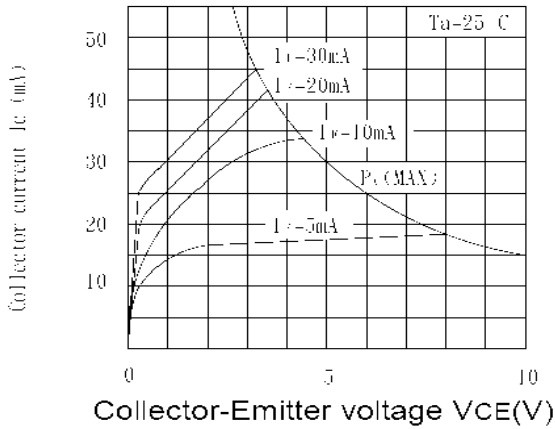

Fig.10 Relative Current Transfer Ratio vs. Ambient Temperature

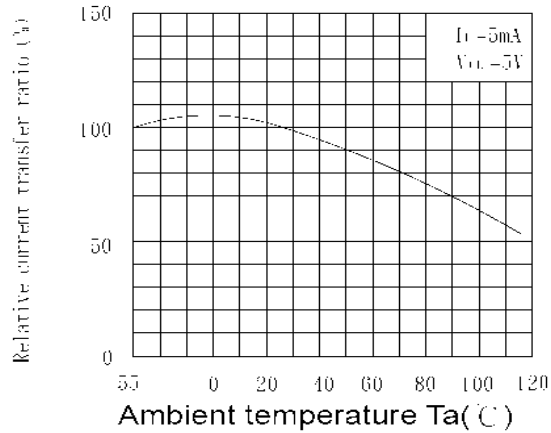

Fig.7 Forward Current vs. Forward Voltage

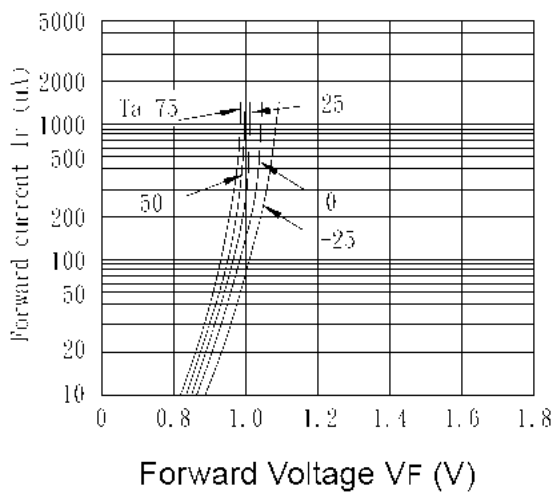
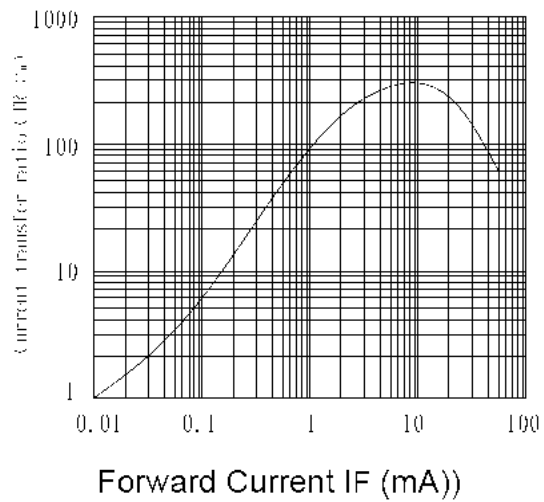

Fig.8 Current Transfer Ratio vs. Forward Current



OPTEK reserves the right to make changes at any time in order to improve design and to supply the best product possible.

OPIA405

Fig. 1 Current Transfer Ratio vs. Forward Current

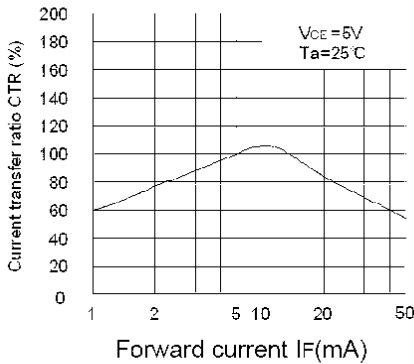

Fig.2 Collector Power Dissipation vs. Ambient Temperature

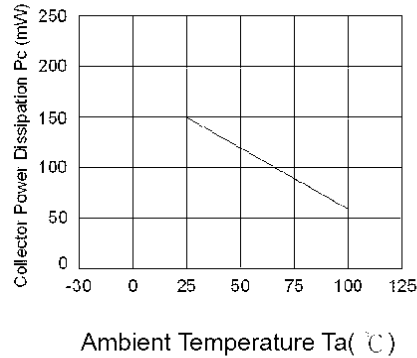

Fig.3 Collector Dark Current vs. Ambient Temperature

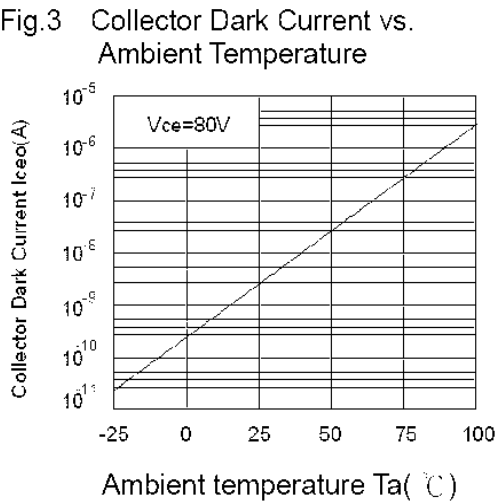

Fig.4 Forward Current vs. Ambient Temperature

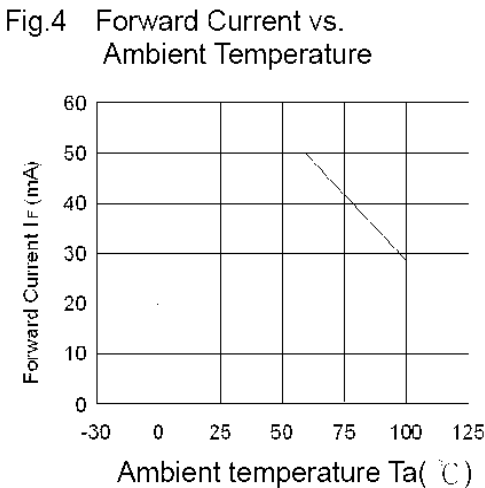

Fig.5 Forward Current vs. Forward Voltage

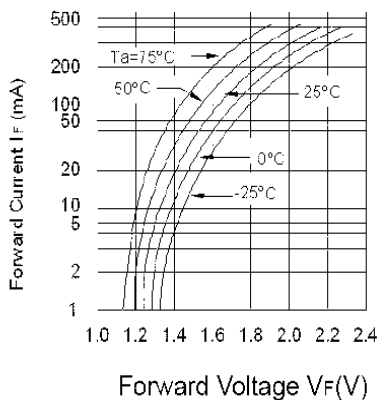
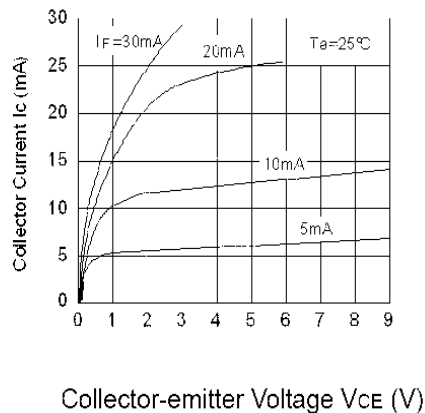

Fig.6 Collector Current vs. Collector-emitter Voltage



OPTEK reserves the right to make changes at any time in order to improve design and to supply the best product possible.

OPIA405

Fig.7 Collector-emitter Saturation Voltage vs. Ambient Temperature

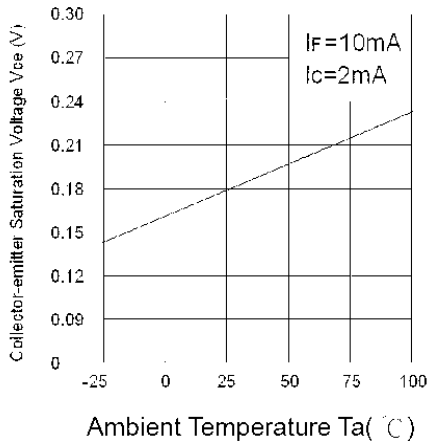

Fig.8 Collector-emitter Saturation Voltage vs. Forward Current

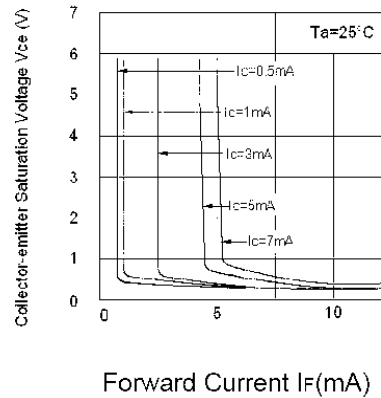

Fig.9 Response Time vs. Load Resistance Fig.10 Response Time vs. Load Resistance

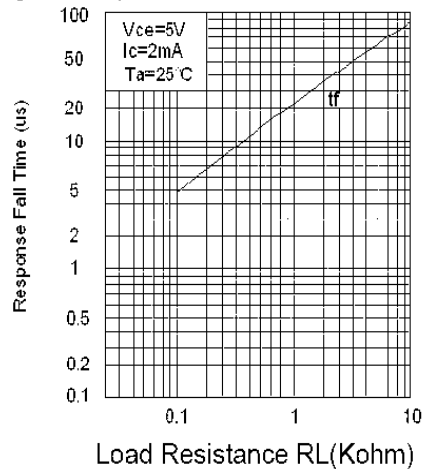
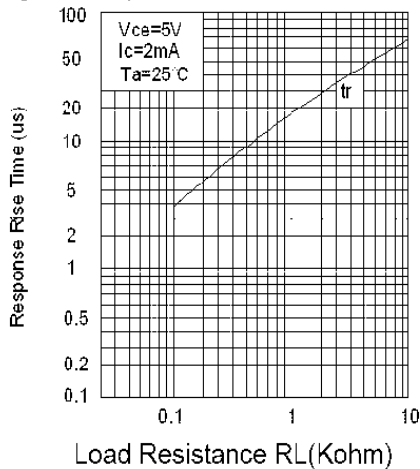
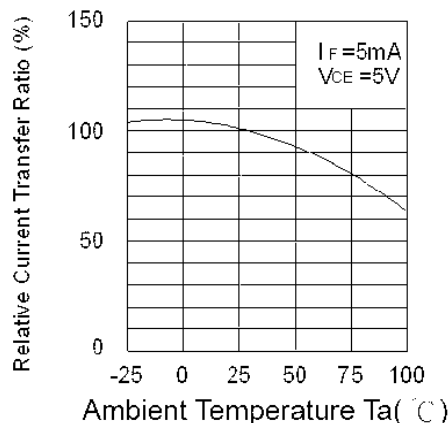

Fig.11 Relative Current Transfer Ratio vs. Ambient Temperature



OPTeK reserves the right to make changes at any time in order to improve design and to supply the best product possible.

OPIA406

Fig.1 Forward Current vs. Ambient Temperature

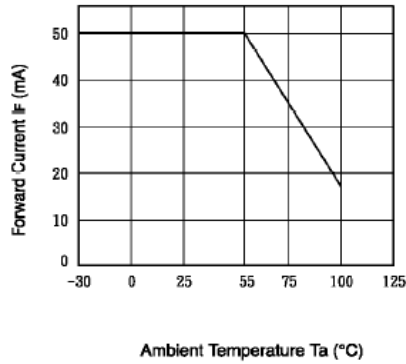

Fig.2 Collector Power Dissipation vs. Ambient Temperature

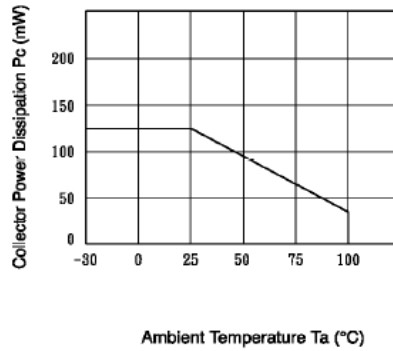

Fig.3 Peak Forward Current vs. Duty Ratio

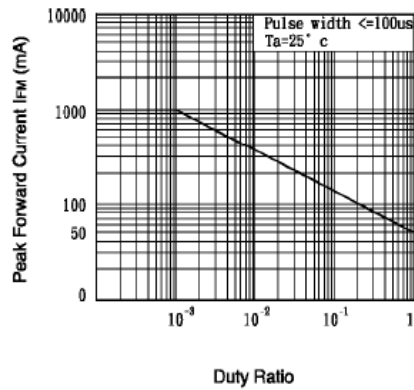

Fig.4 Forward Current vs. Ambient Temperature

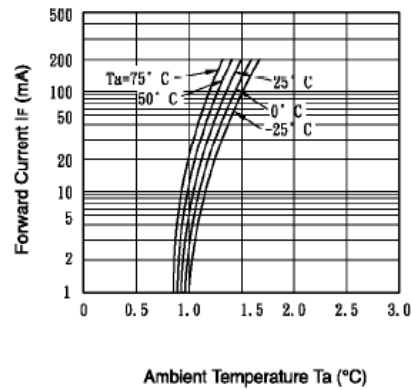
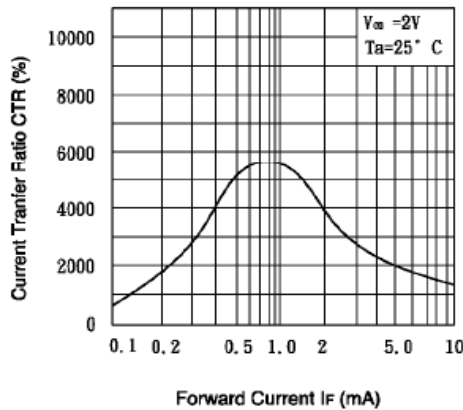

Fig.5 Current Transfer Ratio vs. Forward Current



OPTEK reserves the right to make changes at any time in order to improve design and to supply the best product possible.

OPIA406

Fig.6 Collector Current vs. Collector-emitter Voltage

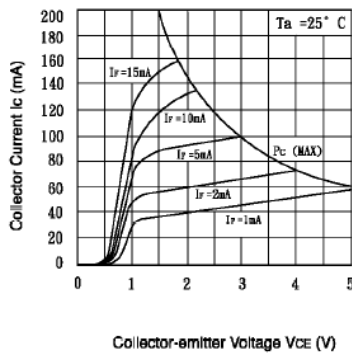

Fig.7 Relative Current Transfer Ratio vs. Ambient Temperature

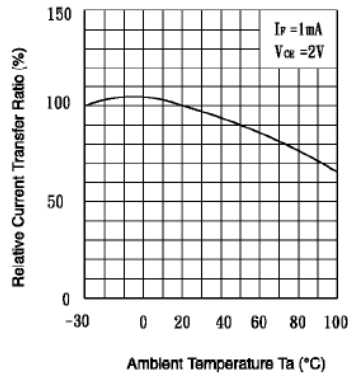

Fig.8 Collector-emitter Saturation Voltage vs. Ambient Temperature

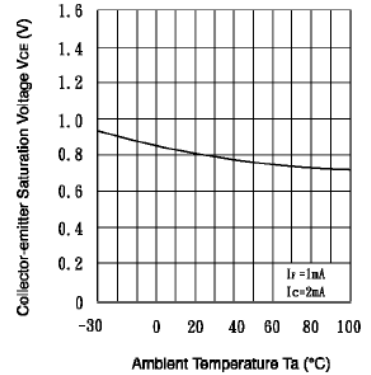

Fig.9 Collector Dark Current vs. Ambient Temperature

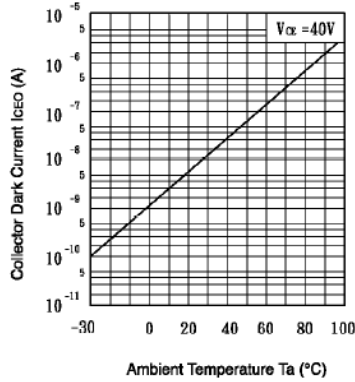

Fig.10 Response Time vs. Load Resistance

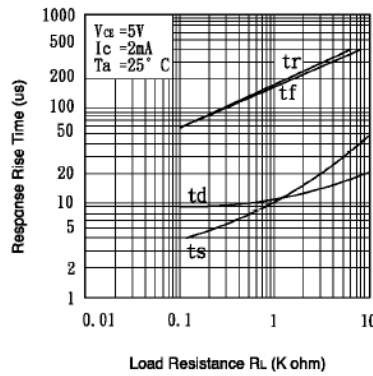
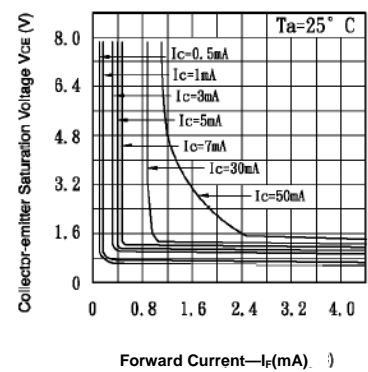

Fig.11 Collector-emitter Saturation Voltage vs. Forward Current



OPTEK reserves the right to make changes at any time in order to improve design and to supply the best product possible.

OPIA407

Fig.1 Current Transfer Ratio vs. Forward Current

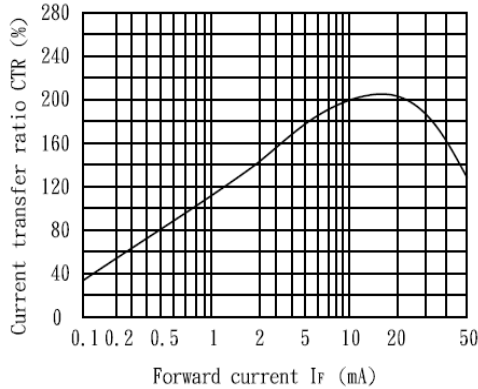

Fig.2 Collector Power Dissipation vs. Ambient Temperature

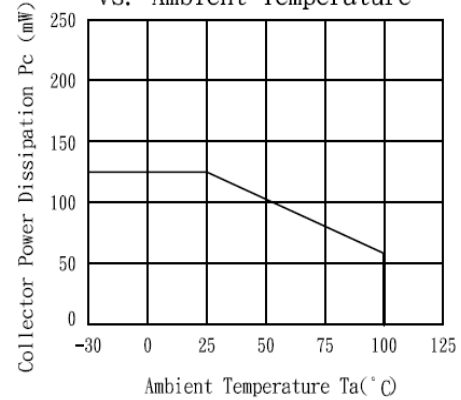

Fig.3 Collector Dark Current vs. Ambient Temperature

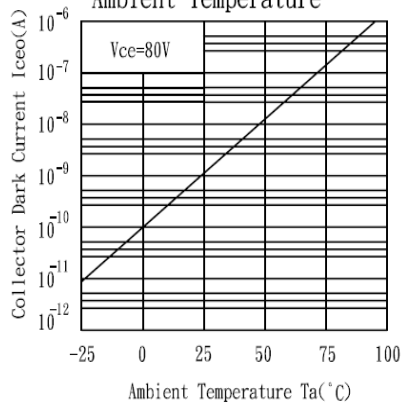

Fig.4 Forward Current vs. Ambient Temperature

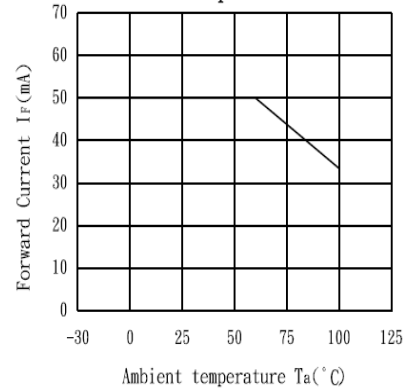

Fig.5 Forward Current vs. Forward Voltage

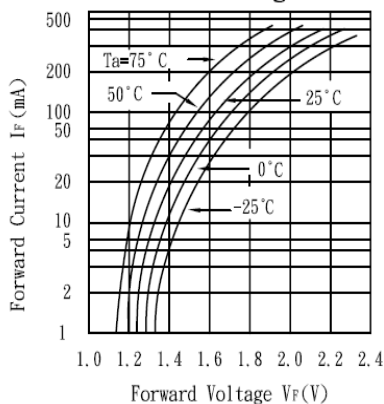
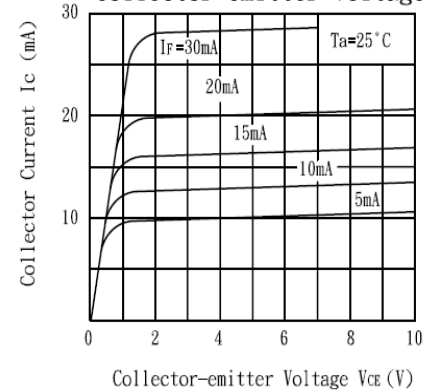

Fig.6 Collector Current vs. Collector-emitter Voltage



OPTeK reserves the right to make changes at any time in order to improve design and to supply the best product possible.

OPIA407

Fig. 7 Collector-emitter Saturation Voltage vs. Ambient Temperature

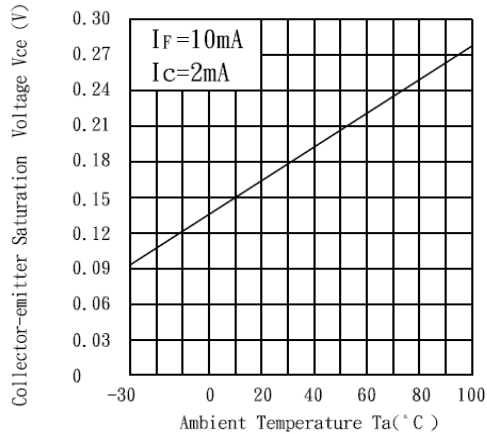

Fig. 8 Collector-emitter Saturation Voltage vs. Forward Current

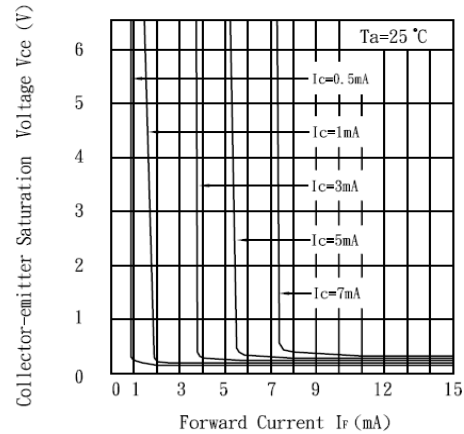

Fig. 9 Response Time vs. Load Resistance

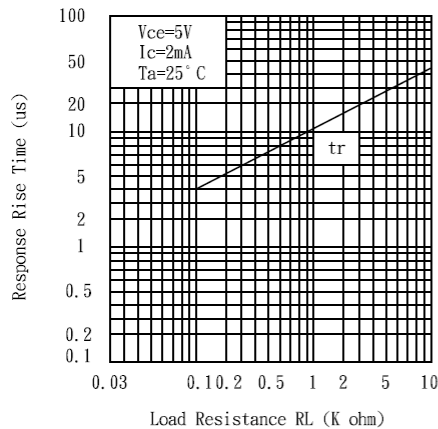

Fig. 10 Response Time vs. Load Resistance

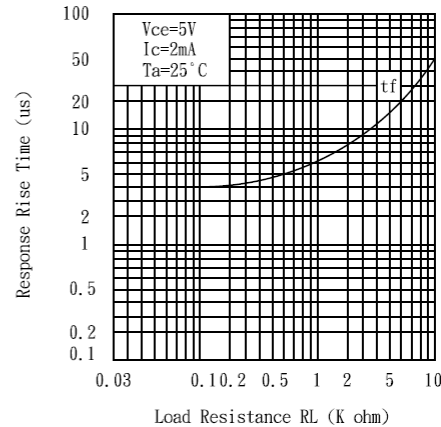
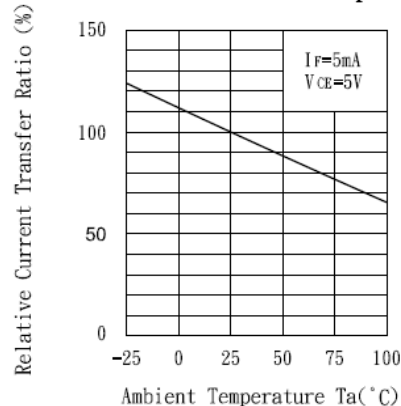
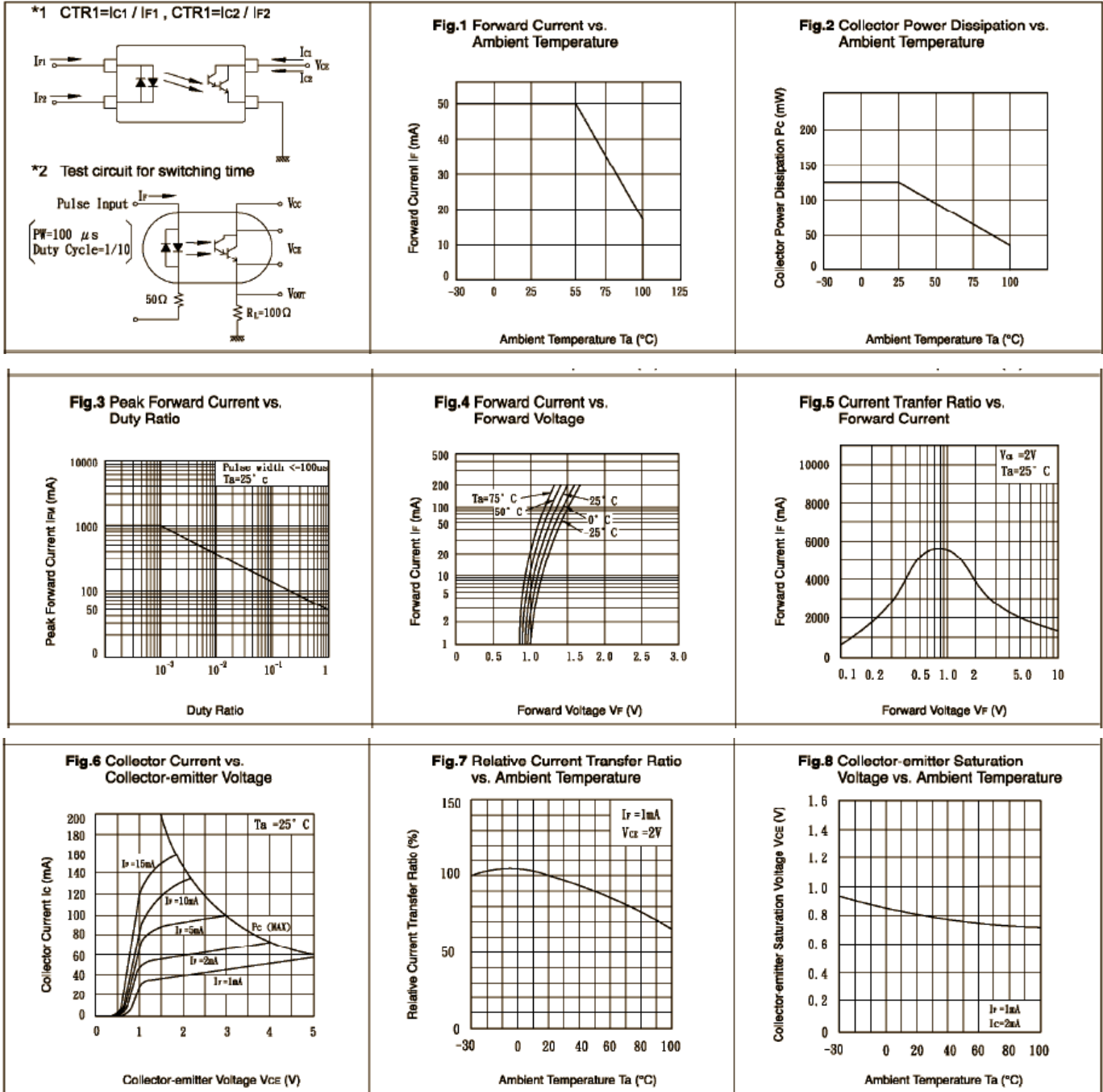

Fig. 11 Relative Current Transfer Ratio vs. Ambient Temperature



OPTEK reserves the right to make changes at any time in order to improve design and to supply the best product possible.

OPIA408



OPTeK reserves the right to make changes at any time in order to improve design and to supply the best product possible.

OPIA408

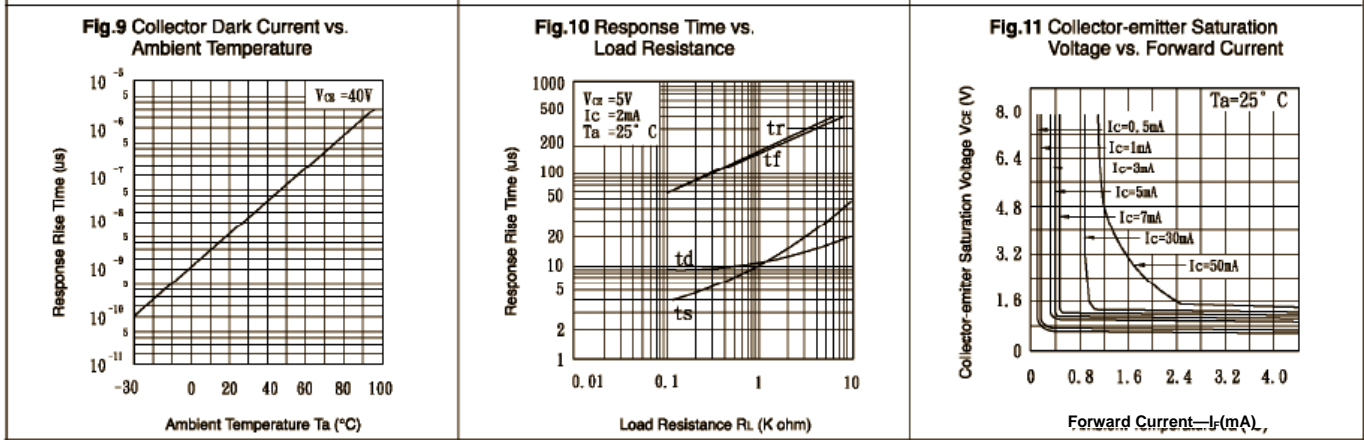

OPTEK reserves the right to make changes at any time in order to improve design and to supply the best product possible.

OPIA409

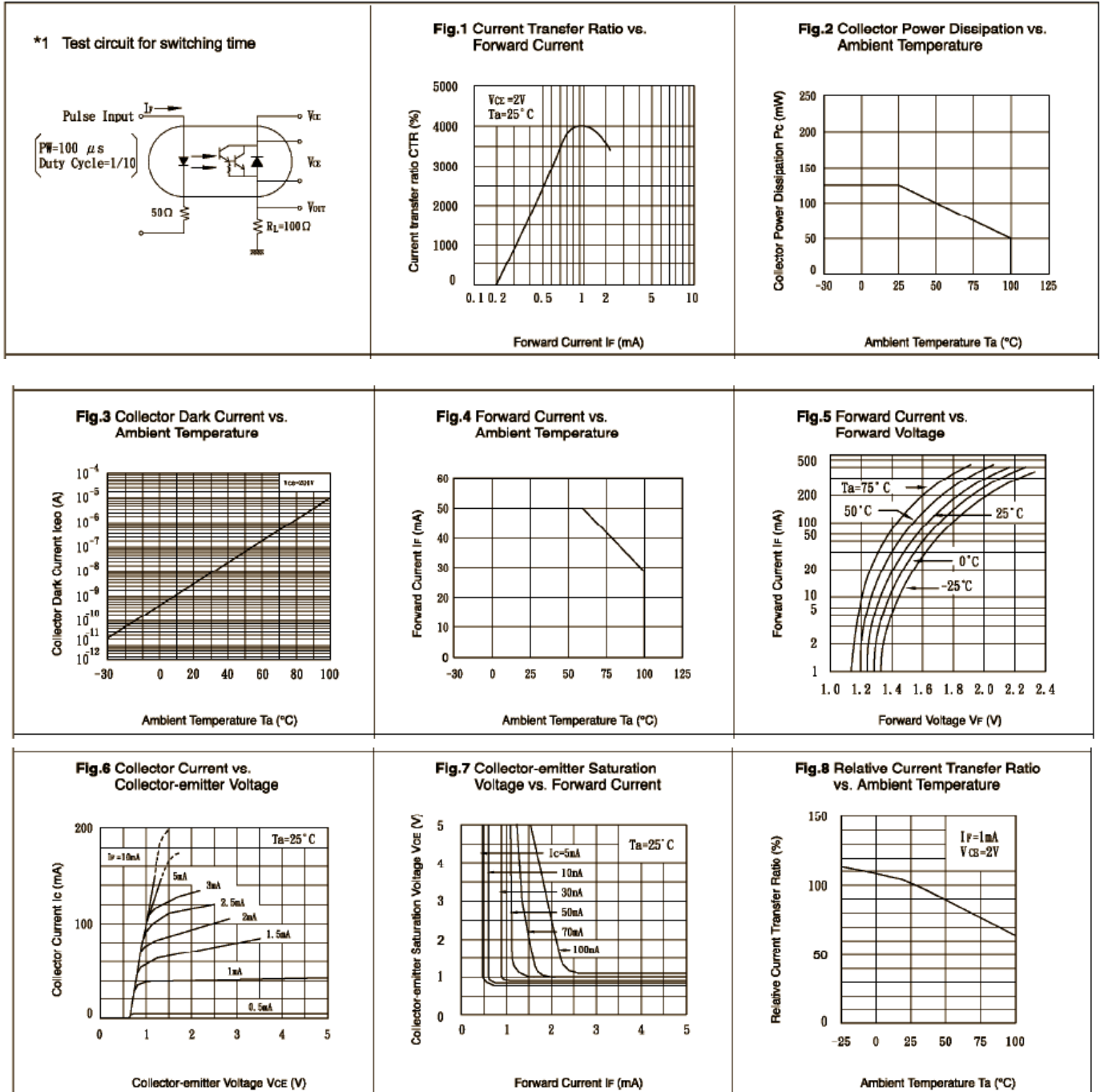

OPTeK reserves the right to make changes at any time in order to improve design and to supply the best product possible.

OPIA409

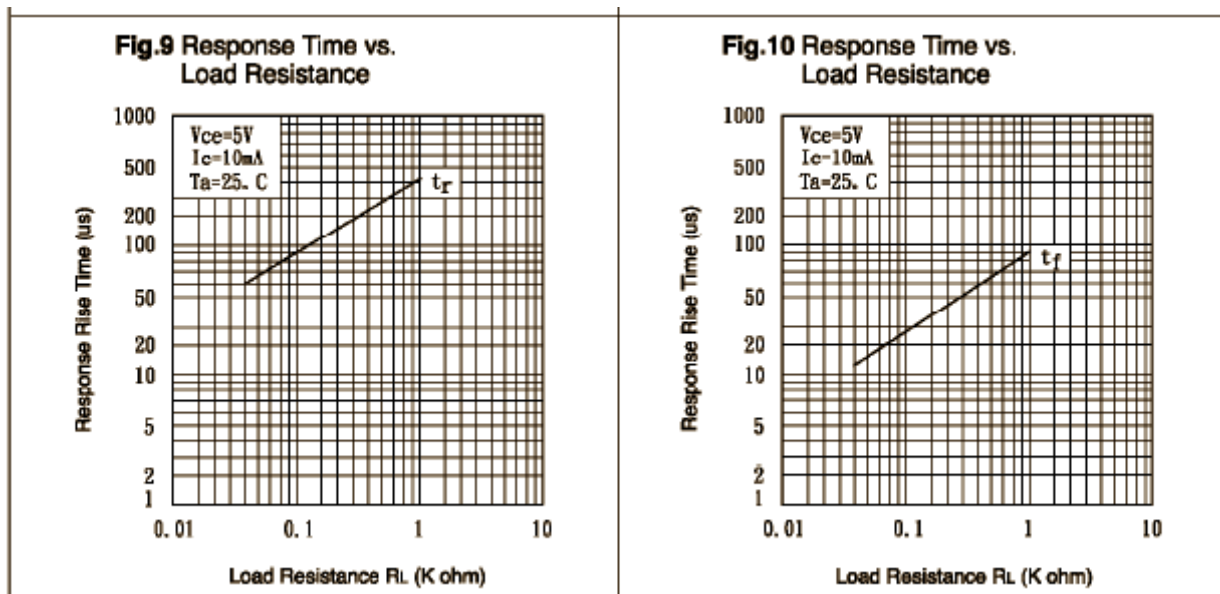

OPTEK reserves the right to make changes at any time in order to improve design and to supply the best product possible.

OPIA414

Fig.1 Current Transfer Ratio vs. Forward Current

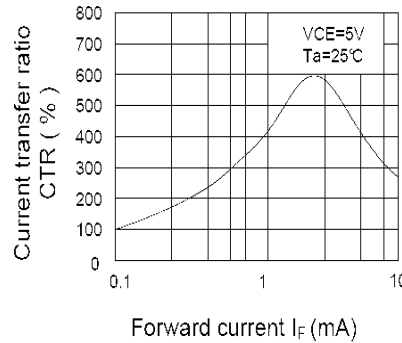

Fig.2 Collector Power Dissipation vs. Ambient Temperature

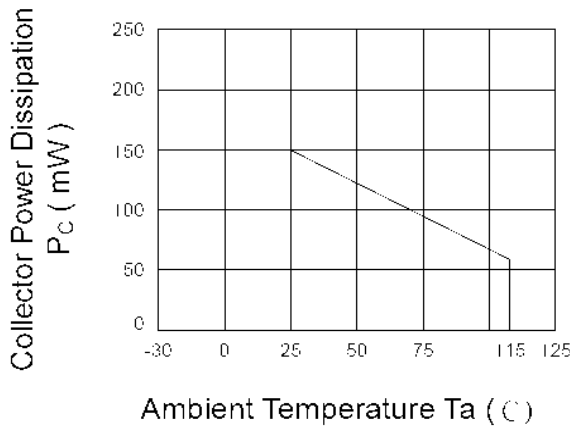

Fig.3 Collector Dark Current vs. Ambient Temperature

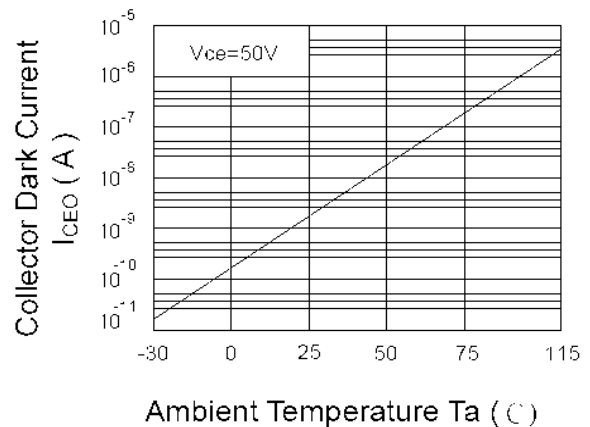

Fig.4 Forward Current vs. Ambient Temperature

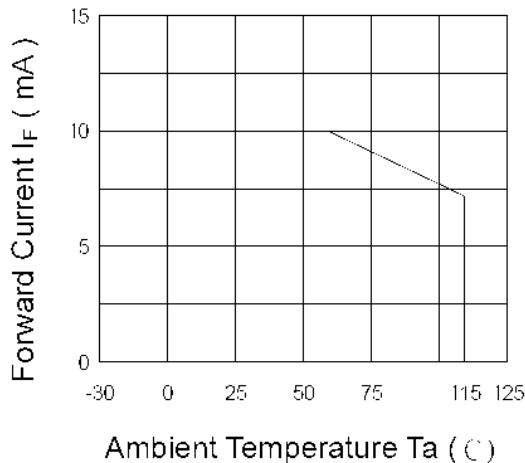
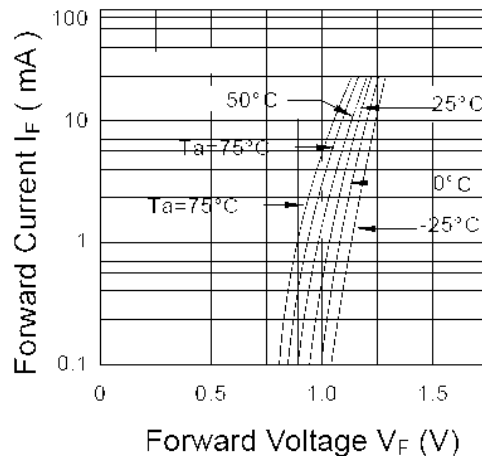

Fig.5 Forward Current vs. Forward Voltage



OPTEK reserves the right to make changes at any time in order to improve design and to supply the best product possible.

OPIA414

Fig.6 Collector Current vs. Collector-Emitter Voltage

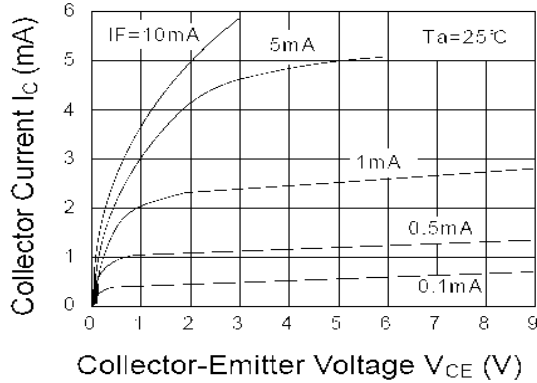

Fig.7 Relative Current Transfer Ratio vs. Ambient Temperature

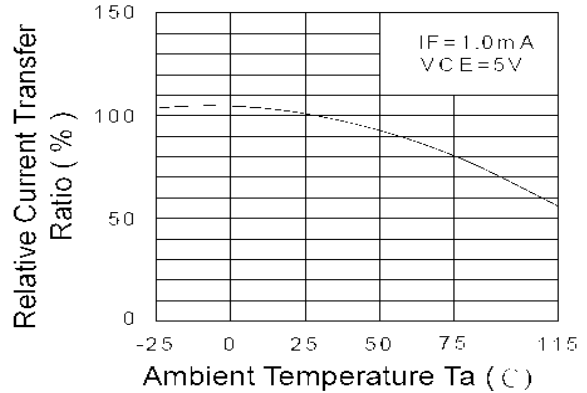

Fig.8 Collector-Emitter Saturation Voltage vs. Ambient Temperature

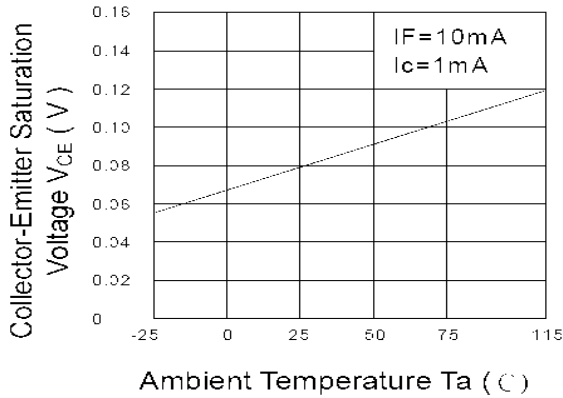

Fig.9 Collector-Emitter Saturation Voltage vs. Forward Current

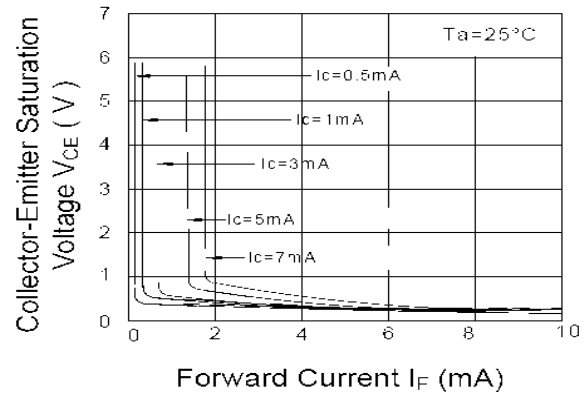

Fig.10 Response Time vs. Load Resistance

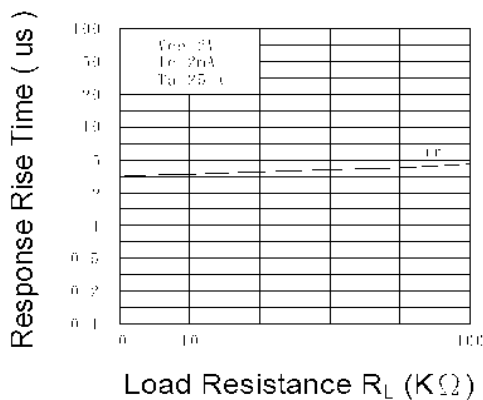
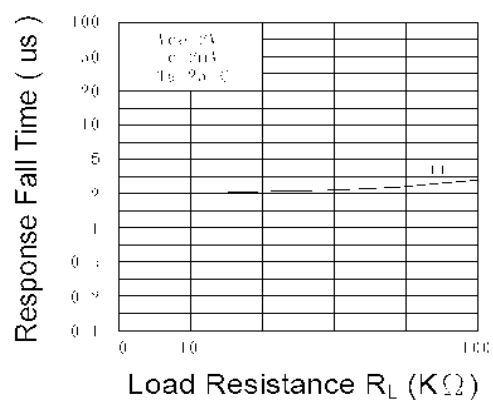

Fig.11 Response Time vs. Load Resistance



OPTEK reserves the right to make changes at any time in order to improve design and to supply the best product possible.

Quality / Reliability Requirements

Parameter	Failure Criteria	Conditions
HTRB D I _{C(OFF)}	± 10%	11 samples after 500Hrs
	0 Fail	@ VCE = 5.0VDC, Ta = 70°C
HTFB D I _{C(ON)}	± 10%	50 samples after 96Hrs
	0 Fail	@ Max P _D , Ta = 25°C
MTTF @ 90% confidence	150,000 Min.	@ 25°C, 25mADC
Moisture Sensitivity Level	MSL 1	per JDEC std J-STD-020B
Lead Solderability	0 Fail	per Method 208 of MIL-STD-202.
Glass Transition of body	125°C Min.	DSC test method
Temperature Humidity-Bias	± 20%	85°C, 85%RH, 500Hrs, 80% min I _{ceo}
Temperature Cycle	± 20%	per Method 1010.7 of MIL-STD-883E
High Temperature Storage	± 20%	85°C, 500Hrs
Autoclave	0 Fail	T _A = 121°C, Pressure = 15psi, Humidity = 100%, Time = 96Hrs

Note: This is to be performed when a change occurs to form, fit or function.

Government and Industry Standard Compliance Requirements

European Union’s Reduction of Hazardous Substances (RoHS) Directive 2002/95/EC







Label Identification

DESCRIPTION:

Size: 3” (7.4 cm) X 2.2” (5.5 cm)
Lettering shall be black on white background.
Format shall be as:

Notes:

1. The DATE CODE is a 4-digit code for date of manufacture where YY is the last two digits of the year, and WW is week number of manufacture.
2. The LOT I.D. is the manufacturing location lot identification where Y is the year of manufacture, NNNN is a sequential lot identifier, and DDD is the day of the year of manufacture. – or use equivalent label format.

 Carrollton, TX, USA MADE IN TAIWAN 
OPTEK P/N <u> OPIA407C-TR </u> 
QTY. <u> N/A </u> 
DATE CODE <u> (Y Y W W) </u> 
LOT I.D. <u> (Y - N N N N D D D) </u> 

OPTEK reserves the right to make changes at any time in order to improve design and to supply the best product possible.

OPIA401 through OPIA409, OPIA414 SMD, SOP and SSOP Packages



Tube Packaging Information:

Optek's Optocoupler Part Numbers		Packaging Quantities		Tube		Inner			Small Carton			Medium Carton			Large Carton		
				Qty	Weight	52 x 7 x 7.5 cm		53.5 x 16 x 17.5 cm			53.5 x 30.7 x 17.5 cm			53.5 x 30.7 x 25 cm			
						Qty	Weight	Qty	Weight	Gross Weight	Qty	Weight	Gross Weight	Qty	Weight	Gross Weight	
P/H and SMD	4-PIN OPIA400D/A	100	44	3,000	1.40	12,000	6.0	6.5	24,000	12.0	12.5	36,000	18.0	18.5			
	6-PIN OPIA6XXD/A Series	65	44	1,950	1.50	7,800	6.5	7.0	15,600	12.0	12.5	23,400	18.5	19.0			
	8-PIN OPIA8XXD Series and OPID804D	48	44	1,440	1.44	5,760	6.0	6.5	11,520	12.0	12.5	17,290	18.0	18.5			
M/F SOP	4-PIN and 5-PIN OPIA401B - OPIA404B, OPIA414B, OPIA500B	100	24	6,000	1.60	24,000	6.5	7.0	48,000	13.0	13.5	72,000	19.5	20.0			
SSOP	4-PIN OPIA405C - OPIA409C	170	--	10,200	--												

P/H = Pin-Hole Packages (Referred as D = Dual-In-Line Package)

SMD = Standard Surface Mount Packages (Referred as A = 6.5mil SMD)

M/F or SOP = Mini-Flat Packages or Small Outside Packages (Referred as B = 4.40mil SMD w/ 2.54mil Lead-Spacing)

SSOP = Shrink SOP Packages (Referred as C = 3.60mil SMD with 1.27mil Lead-Spacing)

OPTEK reserves the right to make changes at any time in order to improve design and to supply the best product possible.

OPIA401 through OPIA409, OPIA414 SMD, SOP and SSOP Packages



Tube Packaging Specifications—SMD— (TU):

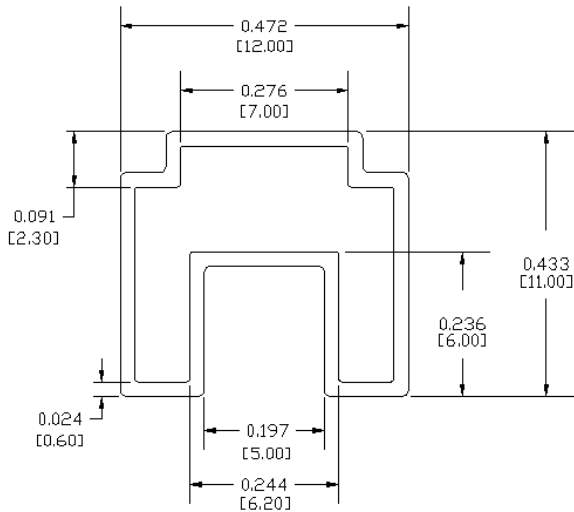

DIMENSIONS ARE IN: INCHES [MILLIMETERS]

TOLERANCE: ± 0.008 INCHES
[± 0.2 MILLIMETERS]

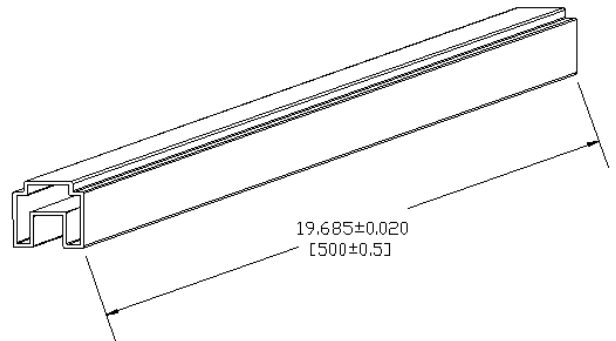

Quantity: 4-pin (SMD): 100pcs/tube

Tube Packaging Specifications— SOP (Mini-flats) and SSOP— (TU):

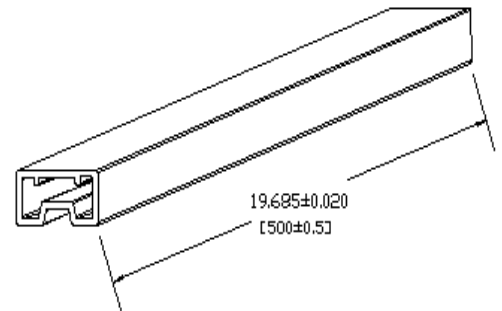
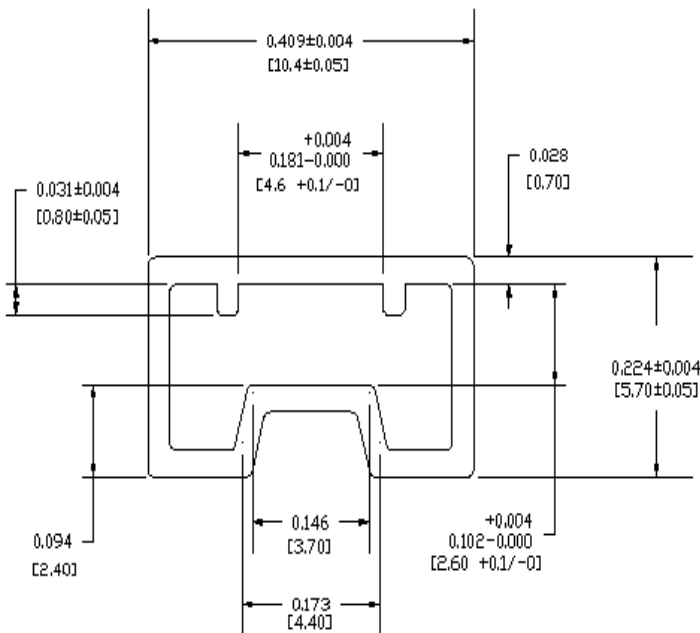

Quantity: 4-pin (SOP): 100pcs/tube
4-pin (SSOP): 170pcs/tube

OPTEK reserves the right to make changes at any time in order to improve design and to supply the best product possible.

Tape and Reel Packaging Specifications— SMD and SOP—(TR):

Tape Feeder:

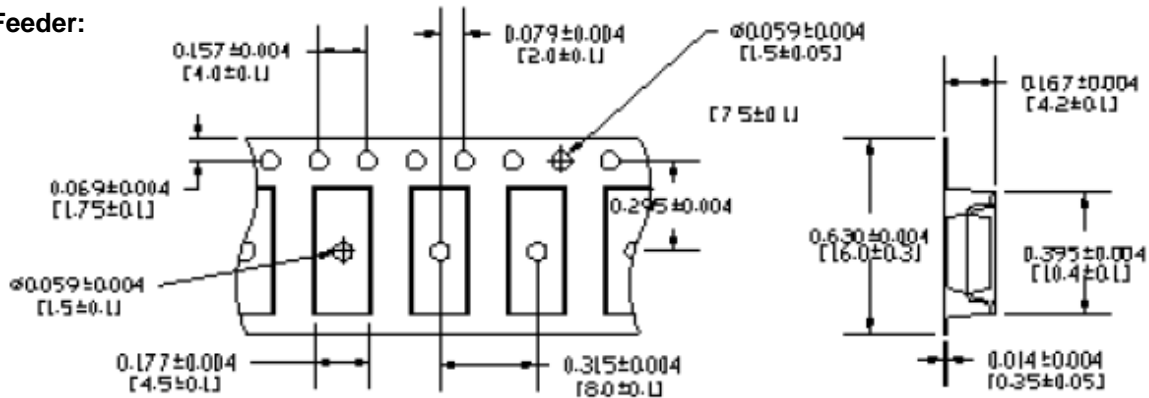

Direction:

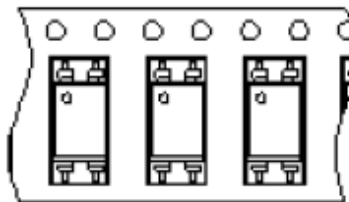

Quantity: 4-pin (SMD): 1000pcs/Reel
4-pin (SOP): 1000pcs/Reel
4-pin (SSOP): 3000pcs/Reel

DIMENSIONS ARE IN: INCHES [MILLIMETERS]

TOLERANCE: ± 0.008 INCHES
[± 0.2 MILLIMETERS]

Reel:

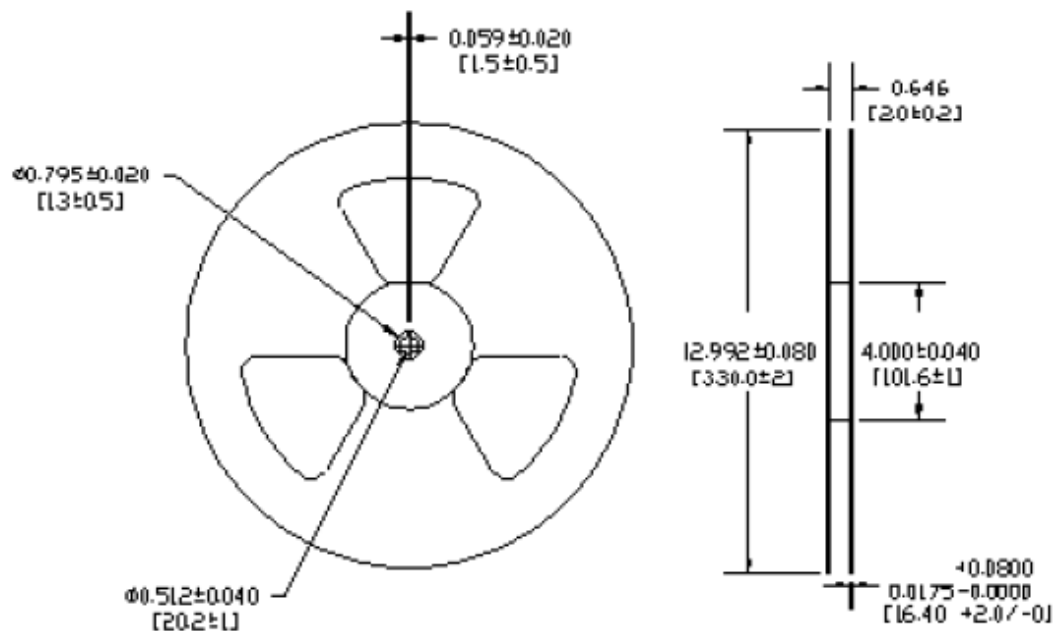

OPTEK reserves the right to make changes at any time in order to improve design and to supply the best product possible.

OPIA401 through OPIA409, OPIA414 SMD, SOP and SSOP Packages



Tape and Reel Packaging Specifications— SSOP—(TR):

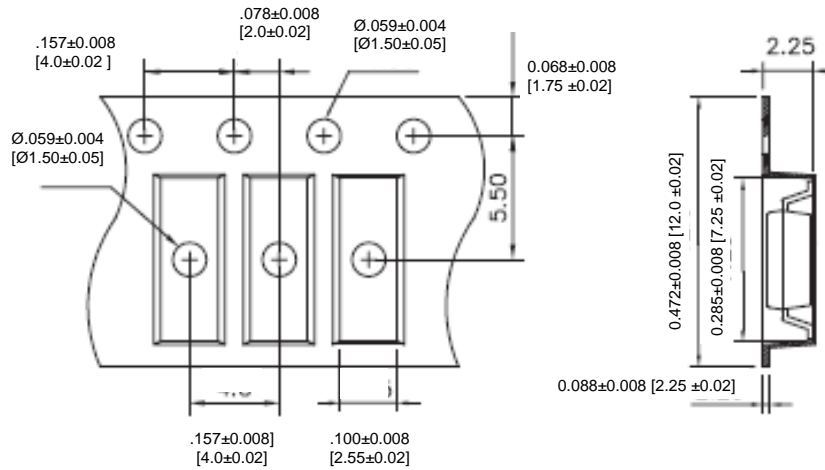

Direction:

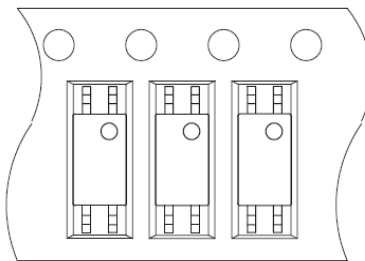

DIMENSIONS ARE IN: INCHES [MILLIMETERS]

**TOLERANCE: ± 0.008 INCHES
[± 0.2 MILLIMETERS]**

Reel:

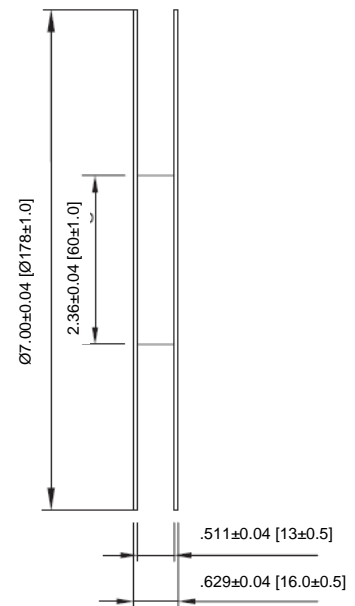
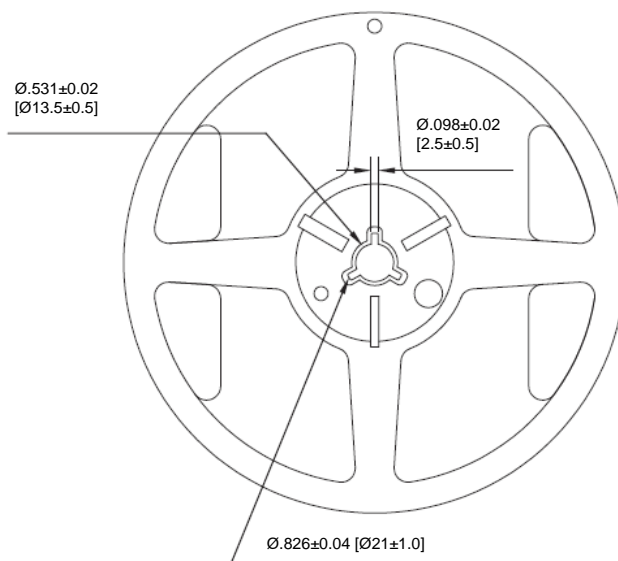

Quantity: 4-pin (SSOP): 2000pcs/Reel

OPTEK reserves the right to make changes at any time in order to improve design and to supply the best product possible.