



**Muffin XL AC - MX2A1 - 028318**  
 (Family) (Model) (Part Number)

### Electrical Specifications

Rated Voltage:	115 VAC
AC Frequency:	60 Hz
Power Supply:	15.0 Watts
Line Current:	0.18 Amps
Locked Rotor Current	0.27 Amps
Nominal Speed:	3100 RPM

### Mechanical Specifications

Dimensions:	4.72in x 1.50in
Weight	21.0 oz
Max Airflow @ 0 in H <sub>2</sub> O	105.0 CFM
Max Pressure @ 0 CFM	0.223 in H <sub>2</sub> O
Noise	47.6 dBA



#### North American Sales Office

Phone: +1 (972) 644 5591  
 sales@comairrotron.com

#### European Sales Office

Phone: +44 7595 221168  
 saleseurope@comairrotron.com

#### Asian Sales Office

Phone: +86 21 623 91966  
 salesasia@comairrotron.com

Print Date: Thursday, March 22, 2012 at 22:55:37 - AC Fan Datasheet - Web Version 1.0 Rev. A



## Mechanical Drawing

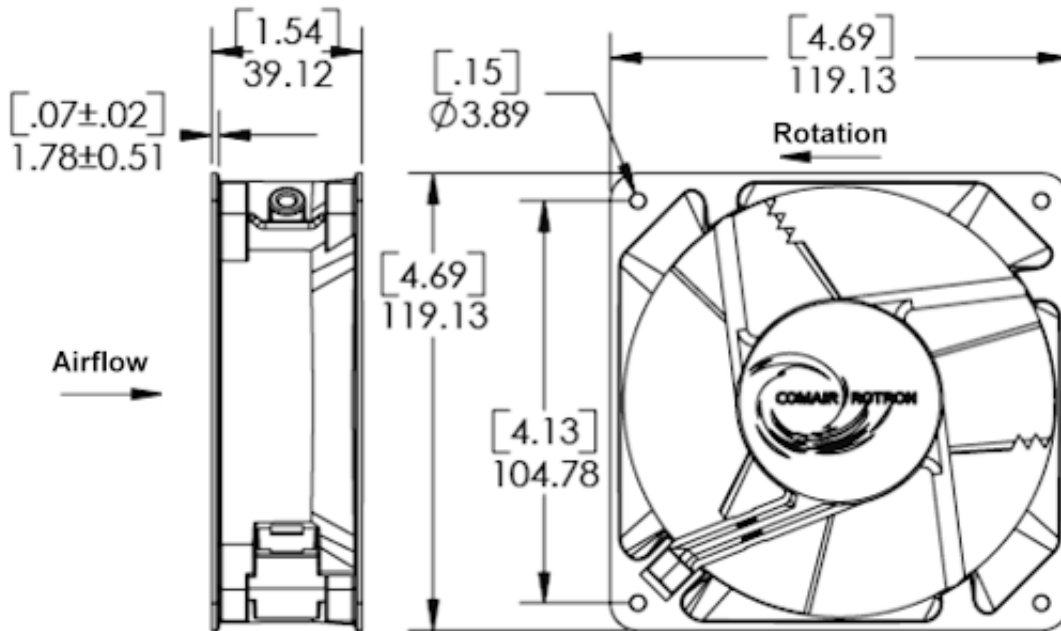

## Options

Part Number	Model Number	Bearing Type	Fan Rotation	Termination	In-Stock <small>(Click 'Yes' for current stock)</small>
<input type="radio"/> 028420	MX2B1	Ball	Normal	0.120 Terminals	No
<input type="radio"/> 030519	MX2B2	Ball	Normal	Leads	No
<input type="radio"/> 028422	MX2B3	Ball	Reverse	0.120 Terminals	No
<input type="radio"/> 030389	MX2B4	Ball	Reverse	Leads	No
<input type="radio"/> 028534	MX2B7	Ball	Reverse	0.187 Terminals	No
<input checked="" type="radio"/> 028318	MX2A1	Sleeve	Normal	0.120 Terminals	No
<input type="radio"/> 030503	MX2A2	Sleeve	Normal	Leads	No
<input type="radio"/> 028316	MX2A3	Sleeve	Reverse	0.120 Terminals	No
<input type="radio"/> 028476	MX2A4	Sleeve	Reverse	Leads	No
<input type="radio"/> 028541	MX2A7	Sleeve	Reverse	0.187 Terminals	No

## Accessories (Click on part number for detailed drawing.)

**428056**  
Plug and Cord

**550440**  
Plug and Cord

**550113**  
Mounting Clip

**551590**  
Filter Assembly

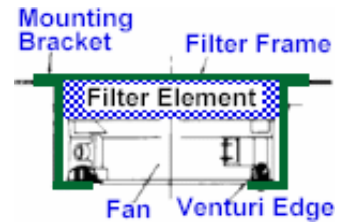
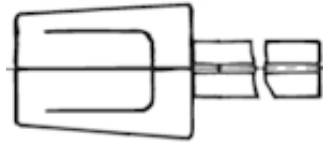
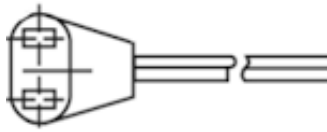

**554148**  
**Filter Guard Assembly**

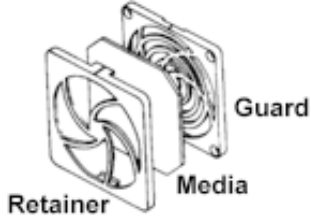

**552934**  
**Finger Guard**



**476042**  
**Finger Guard**

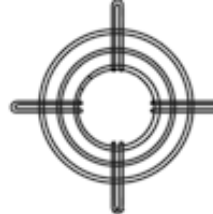

**550481**  
**Finger Guard**

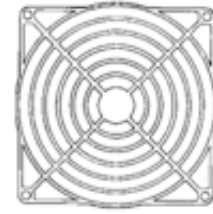

**551147**  
**Finger Guard**



**North American Sales Office**  
Phone: +1 (972) 644 5591  
sales@comairrottron.com

**European Sales Office**  
Phone: +44 7595 221168  
saleseurope@comairrottron.com

**Asian Sales Office**  
Phone: +86 21 623 91966  
salesasia@comairrottron.com

Print Date: Thursday, March 22, 2012 at 22:55:37 - AC Fan Datasheet - Web Version 1.0 Rev. A