



**FEATURES**

- Long lifetime and absolute reliability
- Ideal for use in rough environments
- Resistant anodised aluminium with light fastness factor of 8
- Sea-water resistant
- Tested according to MIL standards
- No maintenance costs, because no mechanical wear parts
- Wide range of materials, colours, shapes and illumination

Type	PSE Standard NO	
<b>Electrical Data</b>		
Switching Voltage max. [VAC/DC]		42 / 60
Switching Current max. [mA]		100
Breaking Capacity max. [W]		1
Lifetime (at Rated Breaking Capacity) [mill.]		20
Insulation Resistance (OFF = not actuated) [MΩ]		> 10
Initial Contact Resistance (ON = actuated) [Ω]		< 20
Capacity [pF]		30
N.O. Closing Impulse Duration (depending on actuating force, time, speed) [ms]		20 - 1000
Contact Configuration		free polarity
Supply Voltage Ring Illumination [VDC]		24
LED Data Point Illumination		see page 39
Switching Function		N.O.
<b>Mechanical Data</b>		
Actuating Force [N]		1 - 3
Actuating Travel [mm]		0.002
Starting Torque [Nm]		2.5
IK Protection Class (Shock Protection) [IK]		IK 02
<b>Climatical Data</b>		
Operating Temperature [°C]		-40 to +85
Storage Temperature [°C]		-40 to +85
IP Protection Class [IP]		IP 69K

In addition to the standard types, additional versions as well as laser lettering are available on request. Starting with catalogue page 36 you will find an overview of the various designs.



PSE M 22 PI

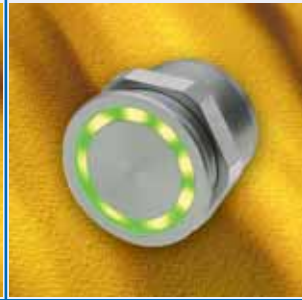

PSE M 22 RI



PSE M 24 RI

**Characteristics**

Mounting Diameter [mm]	22	22	24
Type	PSE Standard NO	PSE Standard NO	PSE Standard NO
Housing Material	Alu. anodised	Alu. anodised	Alu. anodised
Illumination	Point Illumination	Ring Illumination	Ring Illumination
Terminal	Quick Connect Terminal	Wire	Wire
Accessories	All switches are supplied with nut and o-ring seal.		

**Order Number**

Colour of Housing, Colour of Illumination			
Alu natural, red	1241.3020.M	1241.3256	
Alu natural, green	1241.3089.M	1241.3257	
Alu natural, yellow	1241.3047.M		
Alu natural, blue	1241.3244.M		
Alu natural, red / green		1241.3258	1241.3010
red, red	1241.3166.M		
green, green	1241.3167.M		
gold, yellow	1241.3222.M		

**Drawing**

A Illumination Area  
 B Actuating Area  
 C Width Across Flats

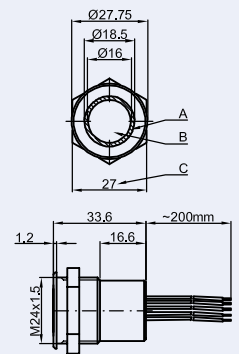
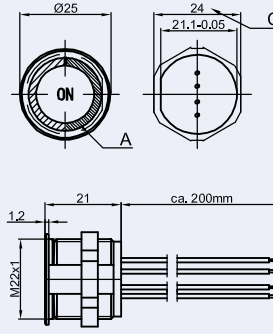
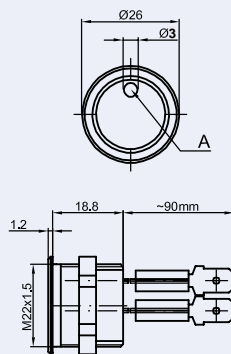

INTEGRATION AS SYSTEM SOLUTION

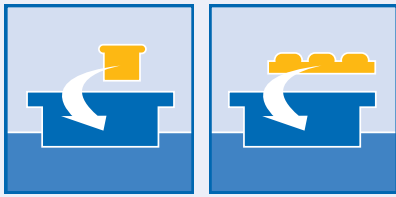

According to customer requirements, Schurter also offers complete function units. The switches or keypads are individually installed in the specific front panel. Schurter additionally offers completely assembled system solutions for integration of further components and electronic modules. An example is the desktop version for Metallic Panel keypads: the input system is installed in a desktop housing with integral trackball for mouse control.

HEATING

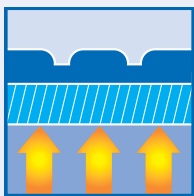

For applications in cold climatic environments, the Metallic Panel keypads can be additionally provided with a heating overlay. For this reason, the keypad is still pleasant to use even at frosty temperatures and the freezing of the switches is prevented.

DATA SHEETS

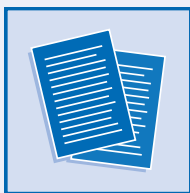

Detailed data sheets are available on demand and on our website: [www.schurter.com](http://www.schurter.com).

LIGHTING TECHNOLOGY

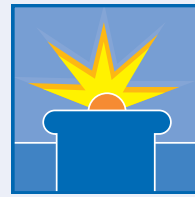

Point illumination

Schurter offers the standard colours red, green, yellow, blue as well as bi-coloured red/green for the point illumination of the switches. Point illuminations in other colours are available on request.

Data of standard LEDs:

Colour	Forward Current $I_F$ [mA]	Forward Voltage $U_F$ [V]
red	40	2,0 (If=10mA)
green	40	2,0 (If=10mA)
yellow	40	2,0 (If=10mA)
blue	20	2,0 (If=10mA)
red/green (piezo switches)	20	2,0 (If=10mA)
red/green (switches with stroke)	25	2,0 / 2,2 (If=20mA)

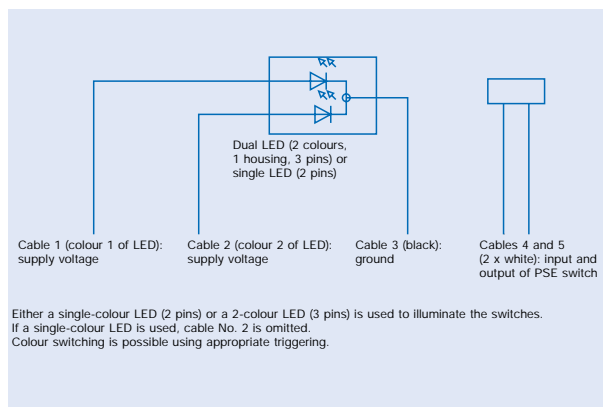

Ring illumination

This design is homogeneous and available in red, green, yellow, blue and bi-coloured red/green as standard colours. Ring illuminations in other colours are also possible.

Data of standard LEDs:

Colour	Current $I_F$ [mA]
red	20
green	20
yellow	20
blue	20

