

Parameter	Rating	Units
Blocking Voltage	60	V_p
Load Current	120	mA_{rms} / mA_{DC}
On-Resistance (max)	16	Ω
LED Current to operate	1	mA

Features

- 1500V_{rms} input/output isolation
- No EMI/RFI generation
- Immune to radiated EM fields
- Small 8-pin SOIC package
- Tape & reel version available
- Flammability rating UL 94 V-0

Applications

- Security
 - Passive infrared detectors (PIR)
 - Data signaling
 - Sensor circuitry
- Instrumentation
- Multiplexers
- Data acquisition
- Electronic switching
- I/O subsystems
- Medical equipment—patient/equipment isolation
- Industrial controls

Pin Configuration

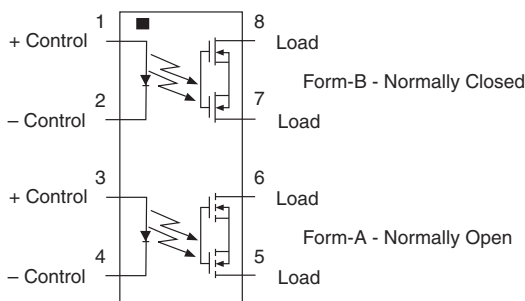

Description

The CPC2317N is a miniature device with one independent normally-open (1-Form-A) solid state relay and one independent normally-closed (1-Form-B) solid state relay in an 8-pin SOIC package. It employs optically coupled MOSFET technology to provide 1500V_{rms} of input to output isolation.

The optically coupled outputs, which use IXYS Integrated Circuits' patented OptoMOS architecture, are controlled by a highly efficient infrared LED.

This device uses IXYS Integrated Circuits' state of the art, double-molded vertical construction packaging to produce one of the world's smallest relays. It is ideal for replacing larger, less-reliable reed and electromechanical relays.

Approvals

- UL Recognized Component: File E76270
- TUV EN 62368-1: Certificate # B 082667 0008

Ordering Information

Part #	Description
CPC2317N	8-Pin SOIC (50/tube)
CPC2317NTR	8-Pin SOIC (2000/reel)

Switching Characteristics of Normally-Open (Form-A) Devices

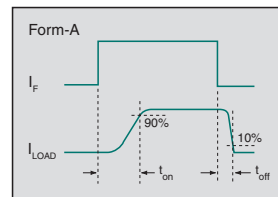

Switching Characteristics of Normally-Closed (Form-B) Devices

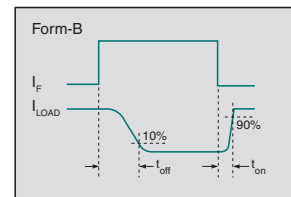

Absolute Maximum Ratings @ 25°C

Parameter	Symbol	Rating	Unit
Blocking Voltage	$V_{L(max)}$	60	V_P
Reverse Input Voltage	V_R	5	V
Input Control Current Peak (10ms)	$I_{F(max)}$	50	mA
		1	A
Total Power Dissipation ¹	P_T	600	mW
Isolation Voltage, Input to Output	V_{ISO}	1500	V_{rms}
Operational Temperature, Ambient	T_A	-40 to +85	°C
Storage Temperature	-	-40 to +125	°C

¹ Derate linearly 5mW / °C

Absolute Maximum Ratings are stress ratings. Stresses in excess of these ratings can cause permanent damage to the device. Functional operation of the device at conditions beyond those indicated in the operational sections of this data sheet is not implied.

Typical values are characteristic of the device at +25°C, and are the result of engineering evaluations. They are provided for information purposes only, and are not part of the manufacturing testing requirements.

Electrical Characteristics @ 25°C

Parameter	Conditions	Symbol	Min	Typ	Max	Units
Output Characteristics						
Load Current						
Normally Open (Form-A) Continuous ¹	$I_F=1mA$	I_L	-	-	120	mA_{rms} / mA_{DC}
Normally Closed (Form-B) Continuous ¹	$I_F=0mA$					
Peak	$t=10ms$	I_{LPK}	-	-	±350	mA_P
On-Resistance ²	$I_L=120mA$	R_{ON}	-	-	16	Ω
Switching Speeds						
Turn-On	$I_F=5mA, V_L=10V$	t_{on}	-	-	3	ms
Turn-Off		t_{off}	-	-	3	
Off-State Leakage Current	$V_L=60V_P$	I_{LEAK}	-	-	1	μA
Output Capacitance						
Normally Open (Form-A)	$I_F=0mA, V_L=50V, f=1MHz$	C_{OUT}	-	5	-	pF
Normally Closed (Form-B)	$I_F=1mA, V_L=50V, f=1MHz$			10	-	
Input Characteristics						
Input Control Current to Activate ³	$I_L=100mA$	I_F	-	0.40	1	mA
Input Control Current to Deactivate	-	I_F	0.1	0.35	-	mA
Input Voltage Drop	$I_F=5mA$	V_F	0.9	1.2	1.4	V
Reverse Input Current	$V_R=5V$	I_R	-	-	10	μA
Common Characteristics						
Capacitance, Input to Output	$V_{IO}=0V, f=1MHz$	C_{IO}	-	1	-	pF

¹ Load current derates linearly from 120mA @ 25°C to 60mA @ 85°C, and must be derated for both poles operating simultaneously.

² Measurement taken within 1 second of on-time.

³ For applications requiring high temperature operation (greater than 60°C) a minimum LED drive current of 3mA is recommended.

Common Performance Data*

Typical LED Forward Voltage Drop
(N=50, $I_F=5\text{mA}$)

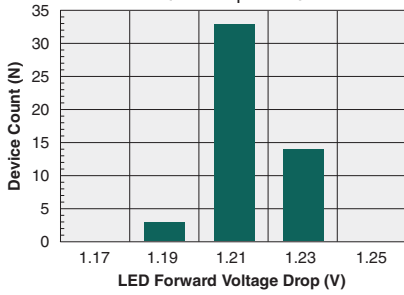

Typical I_F for Switch Operation
(N=50, $I_L=100\text{mA}$)

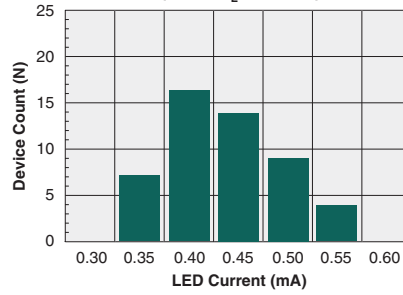

Typical Blocking Voltage Distribution
(N=50)
(Form-A $I_F=0\text{mA}$, Form-B $I_F=2\text{mA}$)

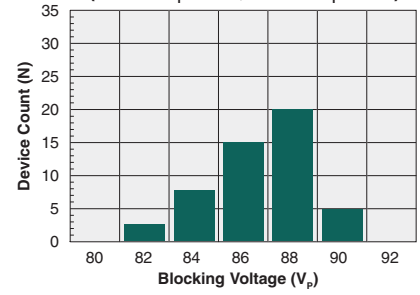

Typical LED Forward Voltage Drop vs. Temperature

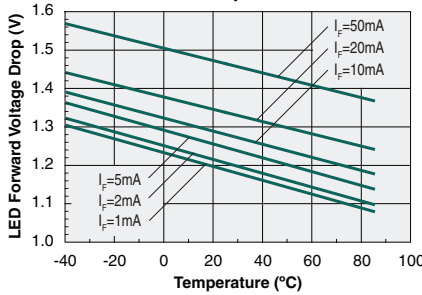

Typical I_F for Switch Operation vs. Temperature
($I_L=80\text{mA}$)

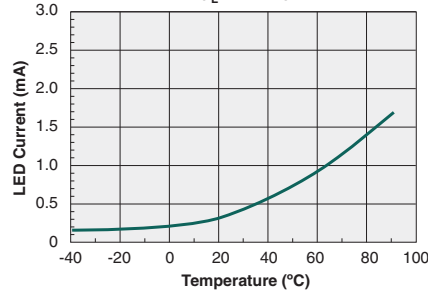

Maximum Load Current vs. Temperature
(Form-A $I_F=2\text{mA}$, Form-B $I_F=0\text{mA}$)

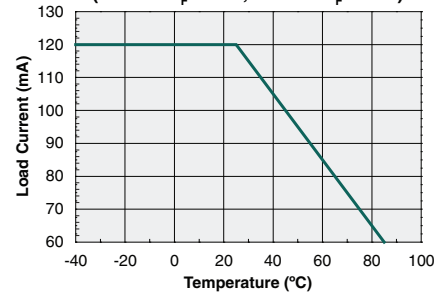

Typical Blocking Voltage vs. Temperature
(Form-A $I_F=0\text{mA}$, Form-B $I_F=2\text{mA}$)

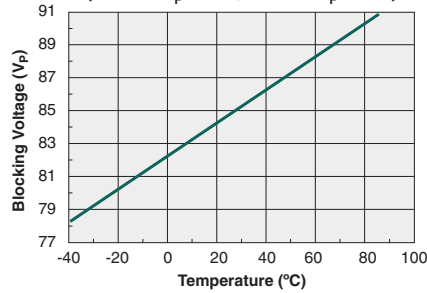

Energy Rating Curve

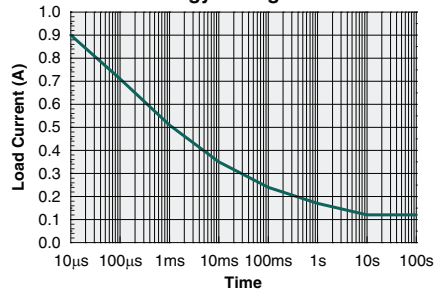

*Unless otherwise noted, data presented in these graphs is typical of device operation at 25°C.

Form-A Performance Data*

Typical Turn-On Time
(N=50, $I_F=5mA$, $I_L=100mA$)

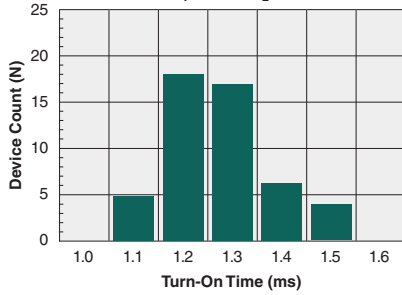

Typical Turn-Off Time
(N=50, $I_L=100mA$, $I_F=5mA$)

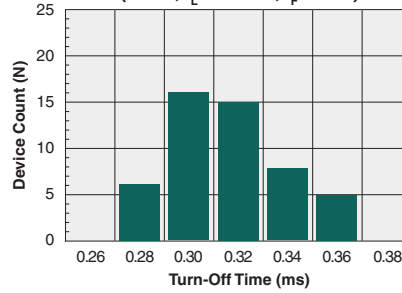

Typical On-Resistance Distribution
(N=50, $I_L=100mA$)

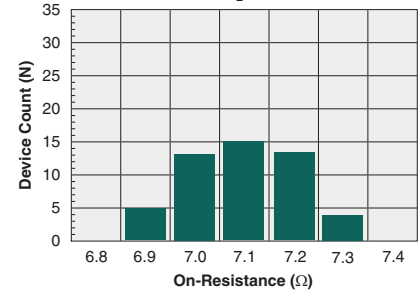

Typical Turn-On Time vs. LED Forward Current
($I_L=100mA$)

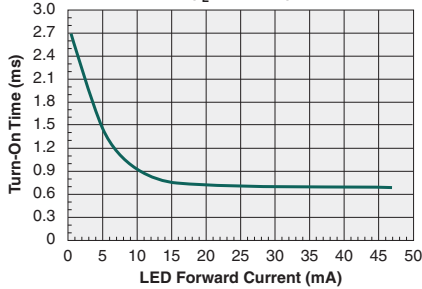

Typical Turn-Off Time vs. LED Forward Current
($I_L=100mA$)

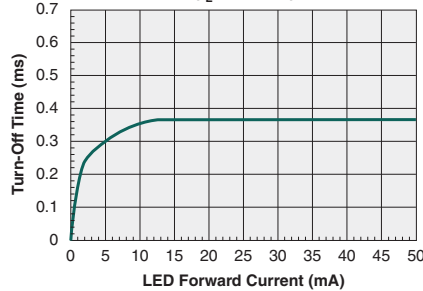

Typical Load Current vs. Load Voltage
($I_F=5mA$)

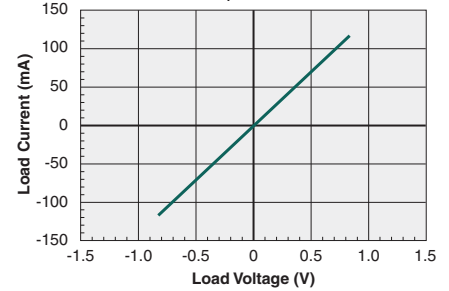

Typical Turn-On Time vs. Temperature
($I_L=50mA$)

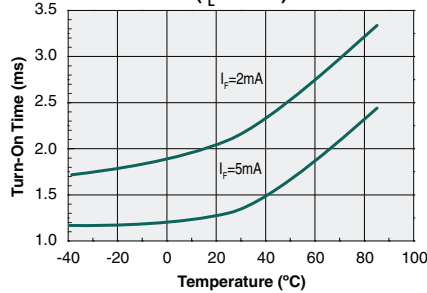

Typical Turn-Off Time vs. Temperature
($I_L=50mA$)

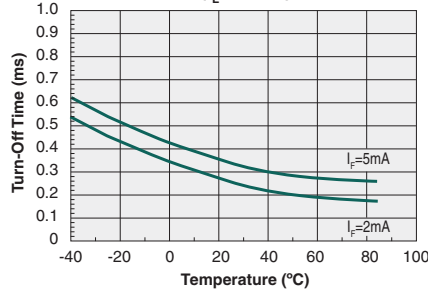

Typical On-Resistance vs. Temperature
($I_L=Max\ Rated\ @\ Temperature$)

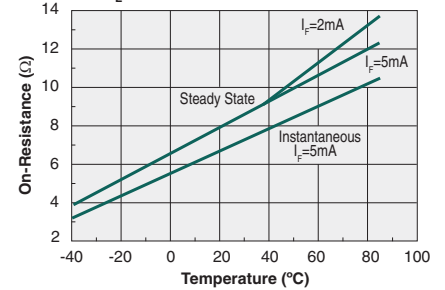

Typical Leakage vs. Temperature
(Measured Across Pins 5&6)
($I_F=0mA$, $V_L=60V$)

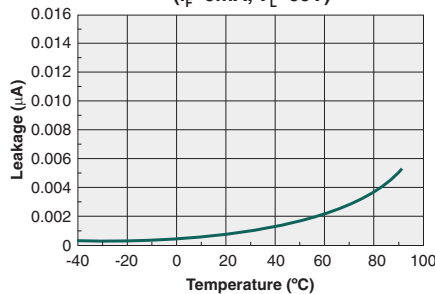

Output Capacitance vs. Load Voltage
($I_F=0mA$, $f=1MHz$)

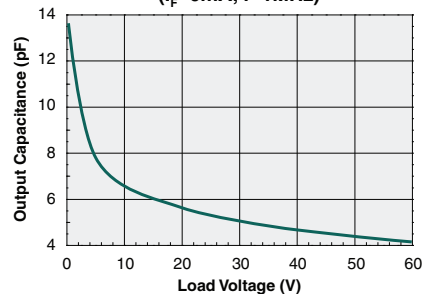

*Unless otherwise noted, data presented in these graphs is typical of device operation at 25°C.

Form-B Performance Data*

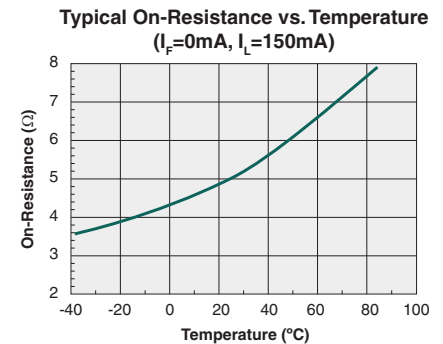
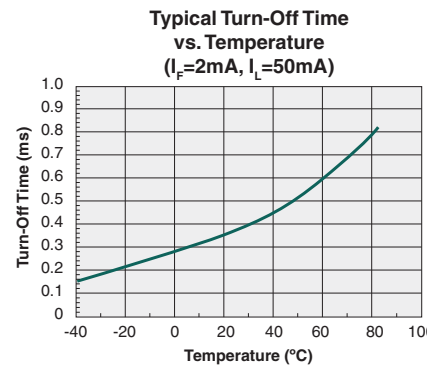
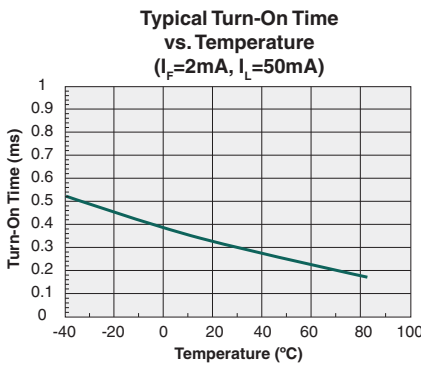
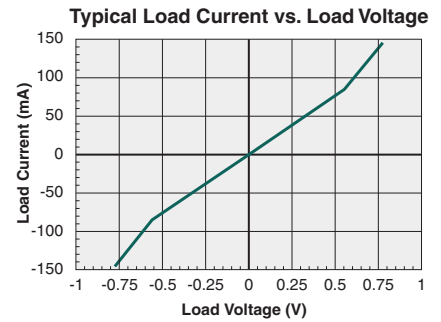
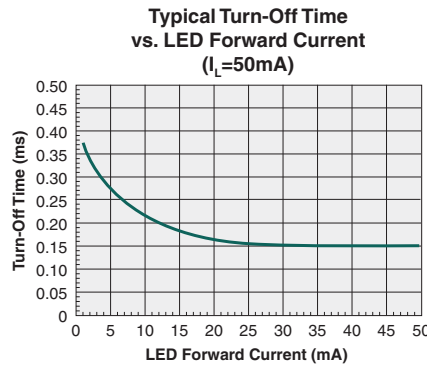
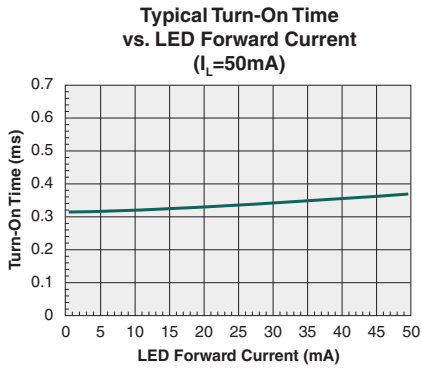
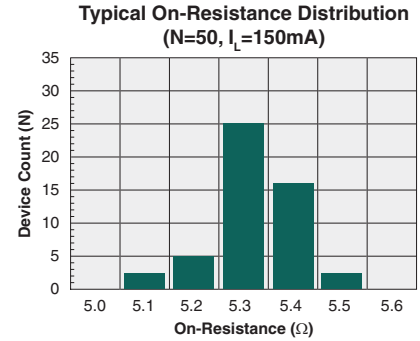
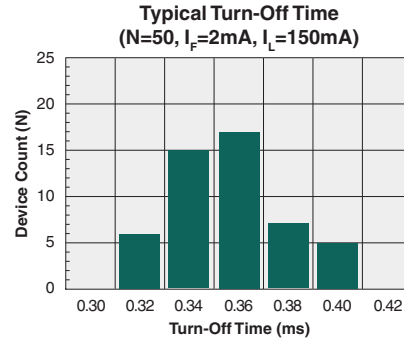
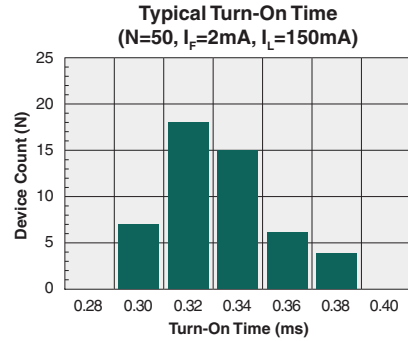

Typical Leakage vs. Temperature Measured Across Pins 7&8
($I_F=2\text{mA}$, $V_L=60\text{V}$)

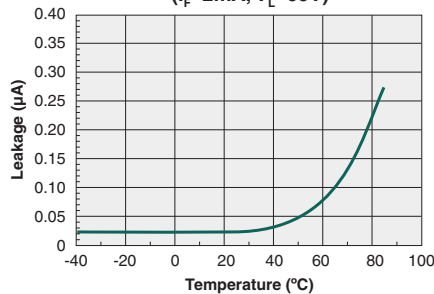

Output Capacitance vs. Load Voltage
($I_F=0.5\text{mA}$)

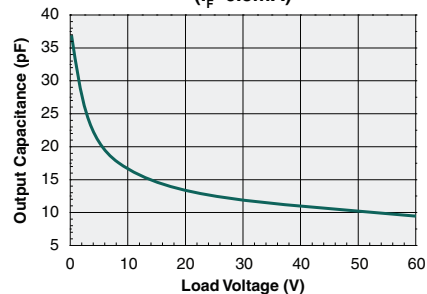

*Unless otherwise noted, data presented in these graphs is typical of device operation at 25°C.

Manufacturing Information

Moisture Sensitivity



All plastic encapsulated semiconductor packages are susceptible to moisture ingress. IXYS Integrated Circuits classifies its plastic encapsulated devices for moisture sensitivity according to the latest version of the joint industry standard, **IPC/JEDEC J-STD-020**, in force at the time of product evaluation. We test all of our products to the maximum conditions set forth in the standard, and guarantee proper operation of our devices when handled according to the limitations and information in that standard as well as to any limitations set forth in the information or standards referenced below.

Failure to adhere to the warnings or limitations as established by the listed specifications could result in reduced product performance, reduction of operable life, and/or reduction of overall reliability.

This product carries a **Moisture Sensitivity Level (MSL)** classification as shown below, and should be handled according to the requirements of the latest version of the joint industry standard **IPC/JEDEC J-STD-033**.

Device	Moisture Sensitivity Level (MSL) Classification
CPC2317N	MSL 3

ESD Sensitivity



This product is ESD Sensitive, and should be handled according to the industry standard **JESD-625**.

Soldering Profile

Provided in the table below is the **IPC/JEDEC J-STD-020** Classification Temperature (T_C) and the maximum dwell time the body temperature of these surface mount devices may be ($T_C - 5$)°C or greater. The Classification Temperature sets the Maximum Body Temperature allowed for these devices during reflow soldering processes.

Device	Classification Temperature (T_C)	Dwell Time (t_p)	Max Reflow Cycles
CPC2317N	260°C	30 seconds	3

Board Wash

IXYS Integrated Circuits recommends the use of no-clean flux formulations. Board washing to reduce or remove flux residue following the solder reflow process is acceptable provided proper precautions are taken to prevent damage to the device. These precautions include but are not limited to: using a low pressure wash and providing a follow up bake cycle sufficient to remove any moisture trapped within the device due to the washing process. Due to the variability of the wash parameters used to clean the board, determination of the bake temperature and duration necessary to remove the moisture trapped within the package is the responsibility of the user (assembler). Cleaning or drying methods that employ ultrasonic energy may damage the device and should not be used. Additionally, the device must not be exposed to halide flux or solvents.



MECHANICAL DIMENSIONS

CPC2317N

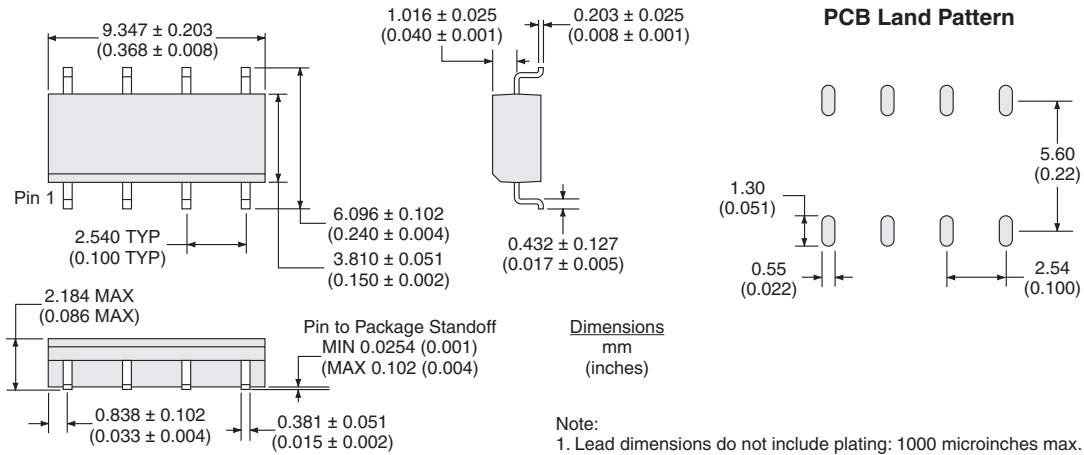

CPC2317NTR Tape & Reel

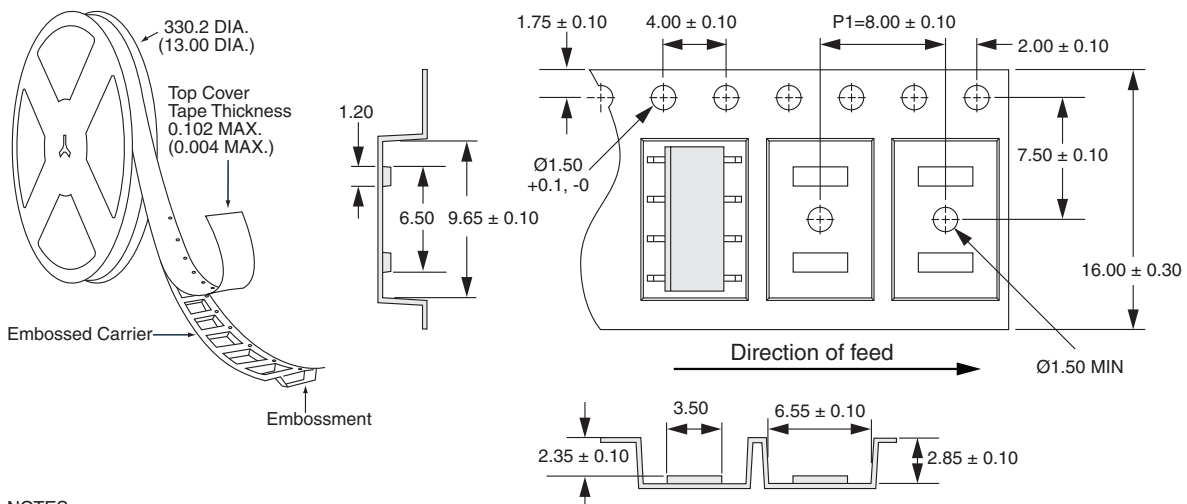

NOTES:

1. All dimensions in millimeters
2. 10 sprocket hole pitch cumulative tolerance ± 0.20 .
3. Carrier camber is within 1mm in 250mm.
4. Tape material : Black Conductive Polystyrene Alloy.
5. All dimensions meet EIA-481-C requirements.
6. Thickness : 0.30 ± 0.05 mm.

For additional information please visit our website at: <https://www.ixysic.com>

Disclaimer Notice - Information furnished is believed to be accurate and reliable. However, users should independently evaluate the suitability of and test each product selected for their own applications. Littelfuse products are not designed for, and may not be used in, all applications. Read complete Disclaimer Notice at <https://www.littelfuse.com/disclaimer-electronics>.