

## Optocoupler, Photodarlington Output, High Gain

### Features

- High Collector to Emitter Breakdown Voltage: 80 V Min
- High Isolation Voltage  $V_{ISO} = 5300 V_{RMS}$
- Base Lead Not Connected
- Solid State Reliability
- Standard DIP Package
- Lead-free component
- Component in accordance to RoHS 2002/95/EC and WEEE 2002/96/EC

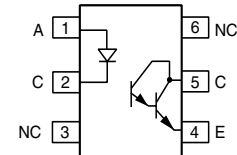
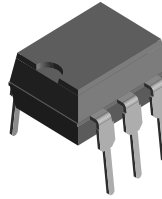

1179013

### Agency Approvals

- UL - File No. E52744 System Code H or J
- DIN EN 60747-5-2 (VDE0884)  
DIN EN 60747-5-5 pending  
Available with Option 1
- CSA 93751
- BSI IEC60950 IEC60065

maintaining a high degree of isolation between driving and load circuits, with no cross talk between channels. These optocouplers can be used to replace reed and mercury relays with advantages of long life, high speed switching and elimination of magnetic fields.

### Applications

### Description

The MOC8050 is an optically coupled isolator with a Gallium Arsenide infrared emitter and a silicon photodarlington sensor. Switching can be achieved while

### Order Information

Part	Remarks
MOC8050	CTR > 500 %, DIP-6
MOC8050-X006	CTR > 500 %, DIP-6 400 mil (option 6)
MOC8050-X007	CTR > 500 %, SMD-6 (option 7)
MOC8050-X009	CTR > 500 %, SMD-6 (option 9)

For additional information on the available options refer to Option Information.

### Absolute Maximum Ratings

$T_{amb} = 25\text{ }^{\circ}\text{C}$ , unless otherwise specified

Stresses in excess of the absolute Maximum Ratings can cause permanent damage to the device. Functional operation of the device is not implied at these or any other conditions in excess of those given in the operational sections of this document. Exposure to absolute Maximum Rating for extended periods of the time can adversely affect reliability.

### Input

Parameter	Test condition	Symbol	Value	Unit
Peak reverse voltage		$V_R$	3.0	V
Continuous forward current		$I_R$	60	mA
Power dissipation		$P_{diss}$	100	mW
Derate linearly from 25 °C			1.33	mW/°C

### Output

Parameter	Test condition	Symbol	Value	Unit
Collector-emitter breakdown voltage		$BV_{CEO}$	80	V
Collector load current			125	mA
Power dissipation		$P_{diss}$	150	mW
Derate linearly from 25 °C			2.0	mW/°C

### Coupler

Parameter	Test condition	Symbol	Value	Unit
Total package dissipation		$P_{tot}$	250	mW
Derate linearly from 25 °C			3.3	mW/°C
Isolation test voltage		$V_{ISO}$	5300	$V_{RMS}$
Isolation resistance	$V_{IO} = 500\text{ V}, T_{amb} = 25\text{ °C}$	$R_{IO}$	$10^{12}$	$\Omega$
	$V_{IO} = 500\text{ V}, T_{amb} = 100\text{ °C}$	$R_{IO}$	$10^{11}$	$\Omega$
Creepage path			$\geq 7$	mm
Clearance path			$\geq 7$	mm
Comparative tracking index			175	
Storage temperature range		$T_{stg}$	- 55 to +125	°C
Operating temperature range		$T_{amb}$	- 55 to +100	°C
Lead soldering time at 260 °C			10	sec.

### Electrical Characteristics

$T_{amb} = 25\text{ °C}$ , unless otherwise specified

Minimum and maximum values are testing requirements. Typical values are characteristics of the device and are the result of engineering evaluation. Typical values are for information only and are not part of the testing requirements.

### Input

Parameter	Test condition	Symbol	Min	Typ.	Max	Unit
Forward voltage	$I_F = 20\text{ mA}$	$V_F$		1.25	1.5	V
Reverse current	$V_R = 3.0\text{ V}$	$I_R$		0.1	10	$\mu\text{A}$
Capacitance	$V_R = 0$	$C_O$		25		pF

### Output

Parameter	Test condition	Symbol	Min	Typ.	Max	Unit
Collector-emitter breakdown voltage	$I_C = 10\text{ }\mu\text{A}$	$BV_{CEO}$	80			V
Collector-emitter leakage current	$V_{CE} = 60\text{ V}, I_F = 0$	$I_{CEO}$		25	1000	nA
Emitter-collector breakdown voltage	$I_C = 10\text{ }\mu\text{A}$	$V_{ECO}$	5.0	8.0		V

### Coupler

Parameter	Test condition	Symbol	Min	Typ.	Max	Unit
Collector-emitter saturation voltage	$I_C = 50\text{ mA}, I_F = 50\text{ mA}$	$V_{CEsat}$		0.9	1.0	V
Isolation test voltage	1.0 s, 60 Hz	$V_{ISO}$		5300		$V_{RMS}$
Capacitance (input-output)		$C_{IO}$		0.5		pF

## Current Transfer Ratio

Parameter	Test condition	Symbol	Min	Typ.	Max	Unit
Current Transfer Ratio	$I_F = 10 \text{ mA}$ , $V_{CE} = 1.5 \text{ V}$	CTR	500			%

## Switching Characteristics

Parameter	Test condition	Symbol	Min	Typ.	Max	Unit
Rise time	$V_{CC} = 13.5 \text{ V}$ , $I_F = 50 \text{ mA}$ , $R_L = 100 \Omega$	$t_r$		10		$\mu\text{s}$
Fall time	$V_{CC} = 13.5 \text{ V}$ , $I_F = 50 \text{ mA}$ , $R_L = 100 \Omega$	$t_f$		35		$\mu\text{s}$

## Typical Characteristics ( $T_{amb} = 25^\circ\text{C}$ unless otherwise specified)

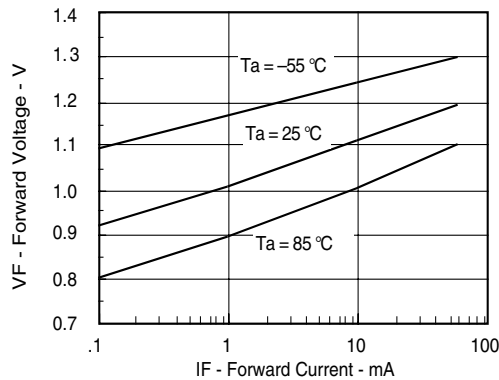

imoc8050\_01

Figure 1. Forward Voltage vs. Forward Current

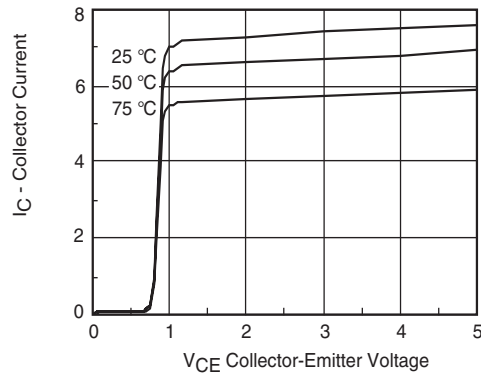

imoc8050\_03

Figure 3. Typical  $I_C$  vs.  $V_{CE}$  vs. Temperature

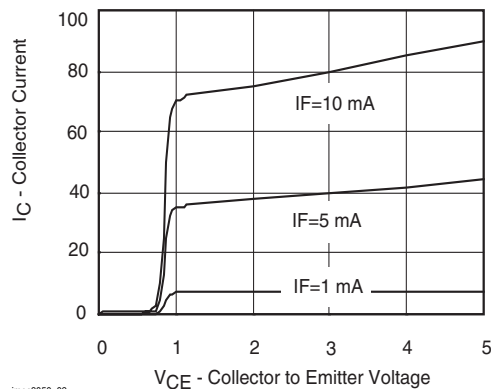

imoc8050\_02

Figure 2. Typical  $I_C$  vs.  $V_{CE}$

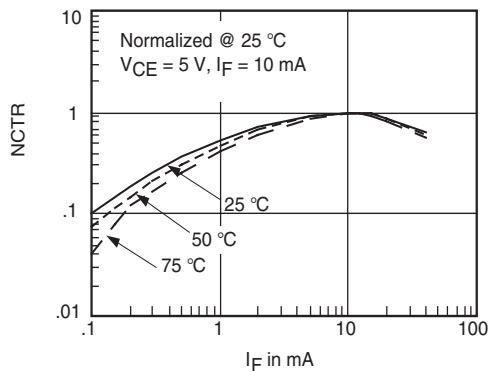

imoc8050\_04

Figure 4. Typical NCTR vs. LED Current

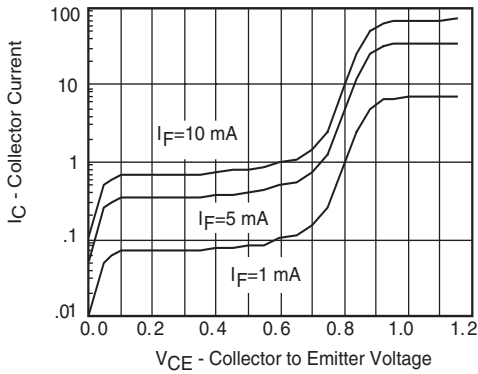

imoc8050\_05

Figure 5. Typical  $I_C$  vs.  $V_{CE}$  (sat region)

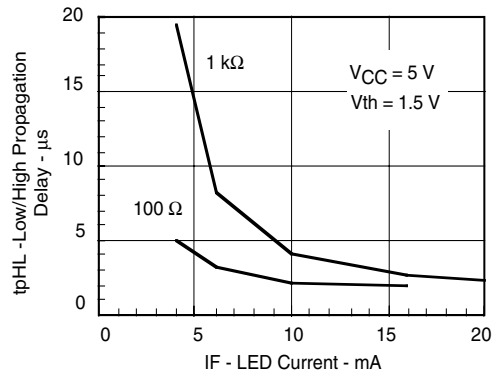

imoc8050\_08

Figure 8. High to low Propagation Delay vs. Collector Load Resistance and LED Current

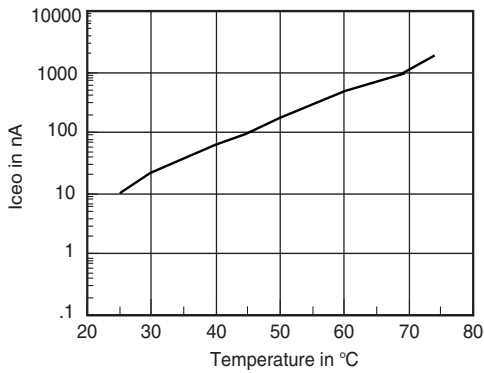

imoc8050\_06

Figure 6. Typical  $I_{CEO}$  vs. Temperature

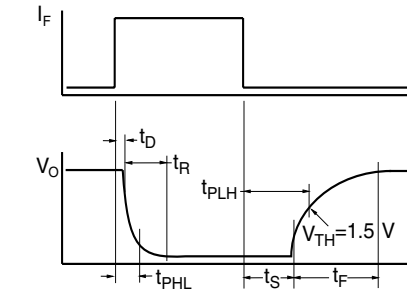

imoc8050\_09

Figure 9. Switching Waveform

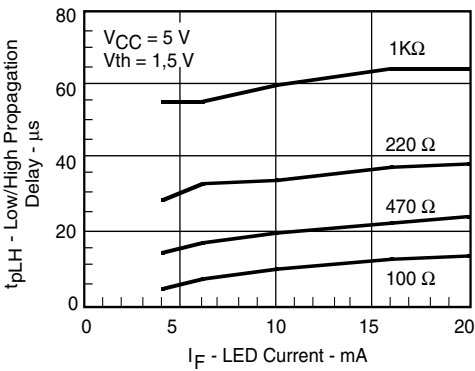

imoc8050\_07

Figure 7. Low to High Propagation Delay vs. Collector Load Resistance and LED Current

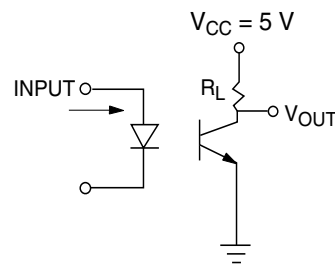

imoc8050\_10

Figure 10. Switching Schematic

## Package Dimensions in Inches (mm)

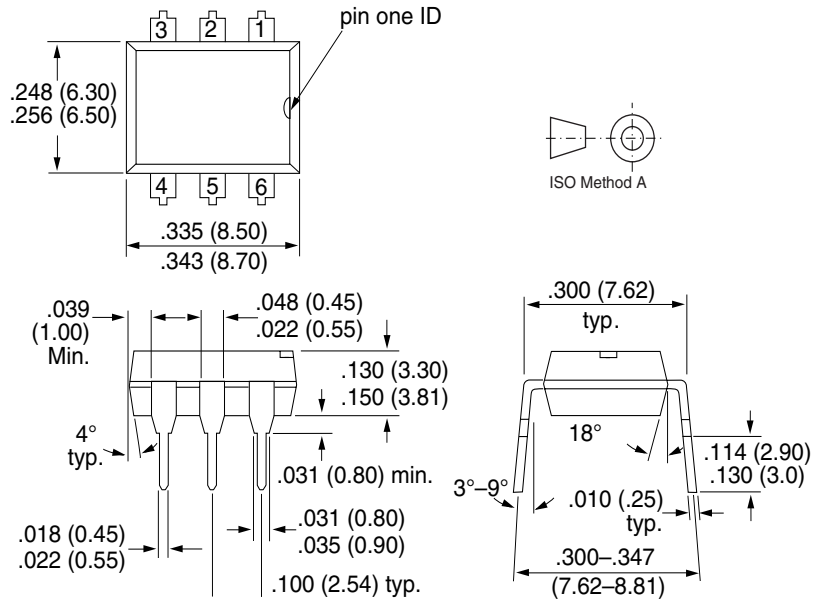

i178004

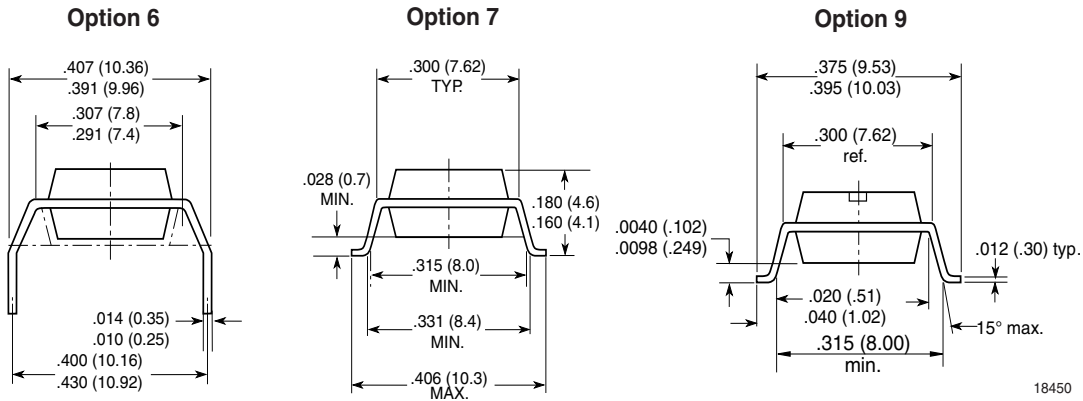

18450

### Ozone Depleting Substances Policy Statement

It is the policy of Vishay Semiconductor GmbH to

1. Meet all present and future national and international statutory requirements.
2. Regularly and continuously improve the performance of our products, processes, distribution and operating systems with respect to their impact on the health and safety of our employees and the public, as well as their impact on the environment.

It is particular concern to control or eliminate releases of those substances into the atmosphere which are known as ozone depleting substances (ODSs).

The Montreal Protocol (1987) and its London Amendments (1990) intend to severely restrict the use of ODSs and forbid their use within the next ten years. Various national and international initiatives are pressing for an earlier ban on these substances.

Vishay Semiconductor GmbH has been able to use its policy of continuous improvements to eliminate the use of ODSs listed in the following documents.

1. Annex A, B and list of transitional substances of the Montreal Protocol and the London Amendments respectively
2. Class I and II ozone depleting substances in the Clean Air Act Amendments of 1990 by the Environmental Protection Agency (EPA) in the USA
3. Council Decision 88/540/EEC and 91/690/EEC Annex A, B and C (transitional substances) respectively.

Vishay Semiconductor GmbH can certify that our semiconductors are not manufactured with ozone depleting substances and do not contain such substances.

We reserve the right to make changes to improve technical design  
and may do so without further notice.

Parameters can vary in different applications. All operating parameters must be validated for each customer application by the customer. Should the buyer use Vishay Semiconductors products for any unintended or unauthorized application, the buyer shall indemnify Vishay Semiconductors against all claims, costs, damages, and expenses, arising out of, directly or indirectly, any claim of personal damage, injury or death associated with such unintended or unauthorized use.

Vishay Semiconductor GmbH, P.O.B. 3535, D-74025 Heilbronn, Germany  
Telephone: 49 (0)7131 67 2831, Fax number: 49 (0)7131 67 2423



### Notice

Specifications of the products displayed herein are subject to change without notice. Vishay Intertechnology, Inc., or anyone on its behalf, assumes no responsibility or liability for any errors or inaccuracies.

Information contained herein is intended to provide a product description only. No license, express or implied, by estoppel or otherwise, to any intellectual property rights is granted by this document. Except as provided in Vishay's terms and conditions of sale for such products, Vishay assumes no liability whatsoever, and disclaims any express or implied warranty, relating to sale and/or use of Vishay products including liability or warranties relating to fitness for a particular purpose, merchantability, or infringement of any patent, copyright, or other intellectual property right.

The products shown herein are not designed for use in medical, life-saving, or life-sustaining applications. Customers using or selling these products for use in such applications do so at their own risk and agree to fully indemnify Vishay for any damages resulting from such improper use or sale.