

ohne Verriegelung
without interlocking

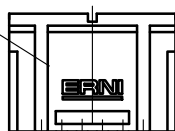

mit Verriegelung
with interlocking

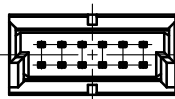
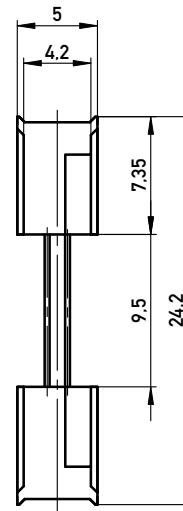
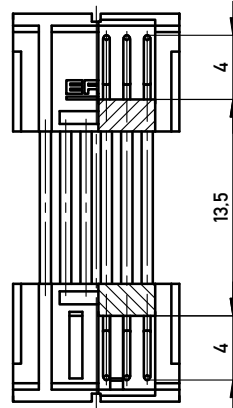
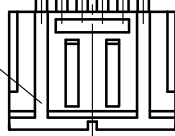

Verpackt in Tray -tray packaging
Verpackungseinheit 78 Stück -packaging unit 78

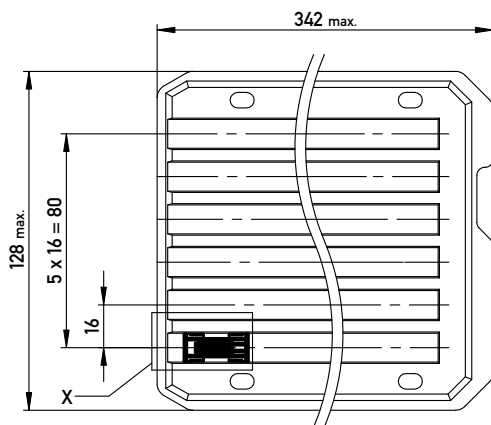

Einzelheit X (M 2:1)
detail X

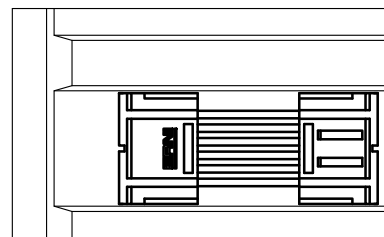

Adapterstück für board-to-board Abstand von 26mm (beidseitig verbaut mit Federleiste: 154805, Low Profile)
Adapter for board-to-board height 26mm (in combination with two female connectors: 154805, low profile)

Copyright by ERNI GmbH Proprietary notice pursuant to ISO 16016 to be observed.	Information:	Tolerances	 All Dimensions in mm	Scale	3:1
	All rights reserved. Only for Information. To ensure that this is the latest version of this drawing, please contact one of the ERNI companies before using.	Subject to modification without prior notice. Drawing will not be updated.	Designation 1,27 DRC Adapterstück BTB 26mm <i>12-polig</i>		
E01	25.06.2008		www.ERNI.com	364097	
Index	Date			Class	DRCBTB
					I
					A3