

LI800P0-Q25LM0-ELIUPN8X3-H1151

Inductive Linear Position Sensor – IO-Link

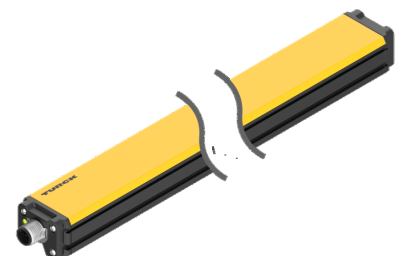
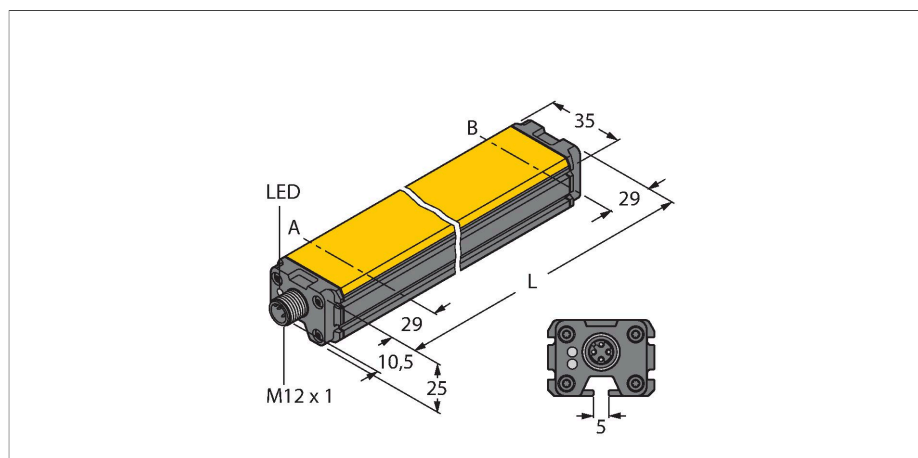

Technical data

Type	LI800P0-Q25LM0-ELIUPN8X3-H1151
ID	1590609
Measuring principle	Inductive
General data	
Measuring range	800 mm
Resolution	0.012 mm/16 bit
Nominal distance	1.5 mm
Blind zone a	29 mm
Blind zone b	29 mm
Reproducibility	≤ 36 μm
Linearity deviation	≤ 0.035 % f.s.
Temperature drift	≤ ± 0.003 %/K
Hysteresis	not applied
Electrical data	
Operating voltage	15...30 VDC
Residual ripple	≤ 10 % U _{ss}
Isolation test voltage	≤ 0.5 kV
Short-circuit protection	yes
Wire breakage/Reverse polarity protection	yes / Complete
Communication protocol	IO-Link
Output function	5-pin, NO/NC, PNP/NPN, analog output
Output 1	Switching output or IO-Link mode
Output 2	Analog or switching output
Voltage output	0...10 V
Current output	4...20 mA
	programmable via IO-Link
Load resistance voltage output	≥ 4.7 kΩ

Features

- Rectangular, aluminium / plastic
- Versatile mounting possibilities
- Measuring range displayed via LED
- Immune to electromagnetic interference
- Extremely short blind zones
- Programmable analog measuring range
- 16-bit resolution
- 15...30 VDC
- Analog output, factory setting 0...10 V
- All functions programmable via IO-Link / -PACTware
- 4 programmable switching zones
- Programmable current and voltage output functions
- NC / NO programmable functions, available as NPN or PNP version
- Process value 16 bit IO-Link telegram
- M12 x 1 male, 5-pin

Wiring diagram

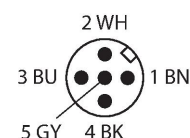
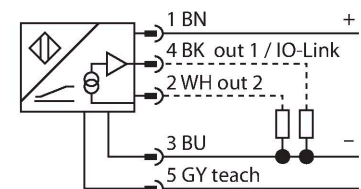

Functional principle

The measuring principle of linear position sensors is based on RLC coupling between the positioning element and the sensor,

Technical data

Load resistance current output	≤ 0.4 kΩ
Sample rate	1000 Hz
Current consumption	< 50 mA
IO-Link	
IO-Link specification	V 1.0
Programming	FDT / DTM
Process data width	16 bit
Frame type	2.2
Included in the SIDI GSDML	Yes
Mechanical data	
Design	Profile, Q25L
Dimensions	858 x 35 x 25 mm
Housing material	Aluminum/plastic, PA6-GF30, Anodized
Active area material	Plastic, PA6-GF30
Electrical connection	Connector, M12 × 1
Environmental conditions	
Ambient temperature	-25...+70 °C
Vibration resistance	55 Hz (1 mm)
Shock resistance	30 g (11 ms)
Protection class	IP67
MTTF	138 years acc. to SN 29500 (Ed. 99) 40 °C
Power-on indication	LED, Green
Measuring range display	multifunction LED, green, yellow, yellow flashing

whereby an output signal is provided proportional to the position of the positioning element. The rugged sensors are wear and tear-free, thanks to the contactless operating principle. They convince through their excellent repeatability, resolution and linearity within a broad temperature range. The innovative technology ensures a high immunity to electromagnetic DC and AC fields.

Mounting instructions

Mounting instructions/Description

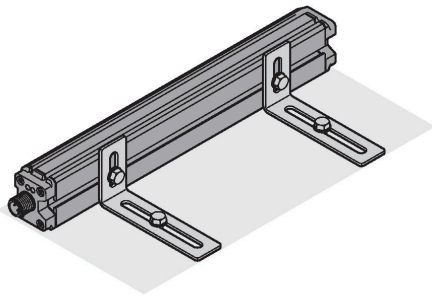
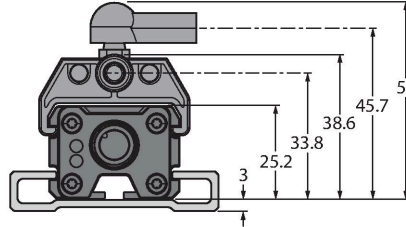
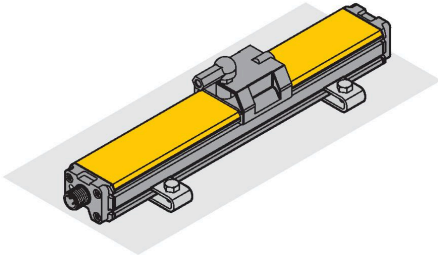

Extensive mounting accessories provide various options for installation. The measuring principle of RLC coupling makes the sensor immune to magnetized metal splinters and other interference fields.

LED indications

- green
positioning element is in the measuring range
- yellow
positioning element is in the measuring range, the distance is too large. This is indicated by a weaker signal
- yellow flashing
positioning element is outside the coverage.
- off
positioning element is outside the programmed area (only with teachable versions)

Teaching

In addition to the setting via IO-link or -PACTware, the start and end point of the measuring range can be set by pressing the button at the teachadapter. Moreover there is the possibility to invert the course of the output curve.

Bridge pin 5 and pin 1 for 10 s = factory setting

Bridge pin 5 and pin 3 for 10 s = factory setting inverted

Bridge pin 5 and pin 3 for 2 s = sets start value of measuring range

Bridge pin 5 and pin 1 for 2 s = sets end value of measuring range

Accessories

P1-LI-Q25L

6901041

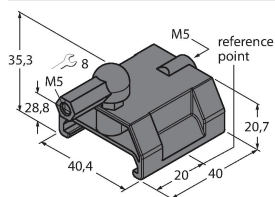

Guided positioning element for linear position sensors LI-Q25L, inserted in the groove of the sensor

P2-LI-Q25L

6901042

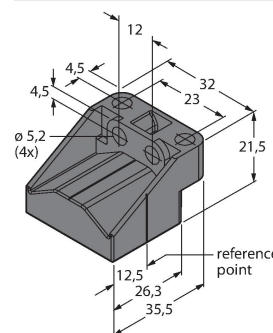

Floating positioning element for linear position sensors LI-Q25L; the nominal distance to the sensor is 1.5 mm; pairing with the linear position sensor at a distance of up to 5 mm or misalignment tolerance of up to 4 mm.

P3-LI-Q25L

6901044

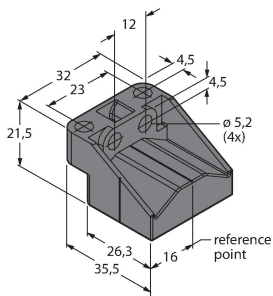

Floating positioning element for LI-Q25L linear position sensors; operational at an offset of 90°; nominal distance to sensor 1.5 mm; pairing with linear position sensor at a distance of up to 5 mm; misalignment tolerance of up to 4 mm

P6-LI-Q25L

6901069

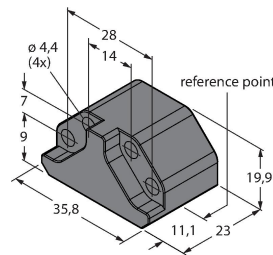

Floating positioning element for linear position sensors LI-Q25L; the nominal distance to the sensor is 1.5 mm; pairing with the linear position sensor at a distance of up to 5 mm or misalignment tolerance of up to 4 mm.

P7-LI-Q25L

6901087

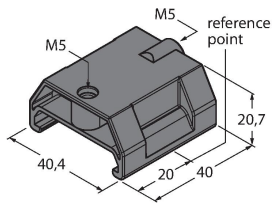

Guided positioning element for linear position sensors LI-Q25L, without ball joint

M1-Q25L

6901045

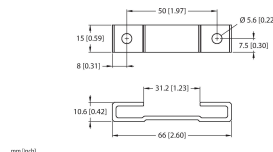

Mounting foot for linear position sensors LI-Q25L; material: aluminum; 2 pcs. per bag

M2-Q25L

6901046

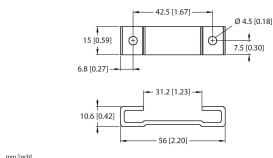

Mounting foot for linear position sensors LI-Q25L; material: aluminum; 2 pcs. per bag

M4-Q25L

6901048

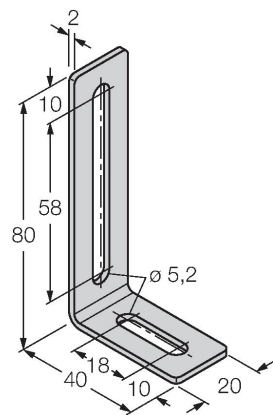

Mounting bracket and sliding block for linear position sensors LI-Q25L; material: stainless steel; 2 pcs. per bag

MN-M4-Q25

6901025

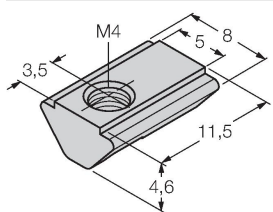

Sliding block with M4 thread for the backside profile of the LI-Q25L; material: galvanized steel; 10 pcs. per bag

AB-M5

6901057

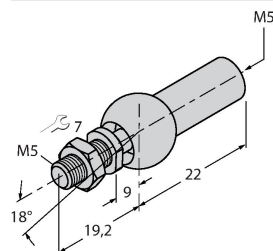

Axial Joint for Guided Positioning Elements

ABVA-M5

6901058

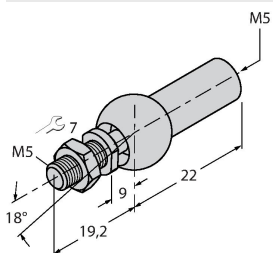

Axial joint for guided positioning element, stainless steel

RBVA-M5

6901059

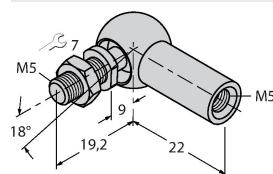

Angle joint for guided positioning element, stainless steel

Accessories

Dimension drawing	Type	ID	
	USB-2-IOL-0002	6825482	IO-Link Master with integrated USB port

